

Model solutions to old problem set questions

Sections

1	Competitive markets	1
2	Market power	28
3	Public goods, welfare analysis	45
4	Tools, foundations	67
5	Decision analysis	104
6	Strategy	124
7	Pricing	168
8	Externalities	191
9	Information	212

1 Competitive markets

1. Ann’s explanation about the impact of television shows is an argument based on a change in consumer preferences; in the supply-and-demand framework this amounts to a rightward shift in the demand curve ($D \rightarrow D^*$). Bob’s explanation about weaker border controls is an argument based on an increase in supply, which amounts to a rightward shift in the supply curve ($S \rightarrow S^*$). While both hypotheses are consistent with increased consumption (i.e., higher quantity) they lead to opposite predictions about the change in the market price of illicit drugs. Ann’s explanation would be consistent with an increase in the price, while Bob’s explanation would be consistent with a decrease.

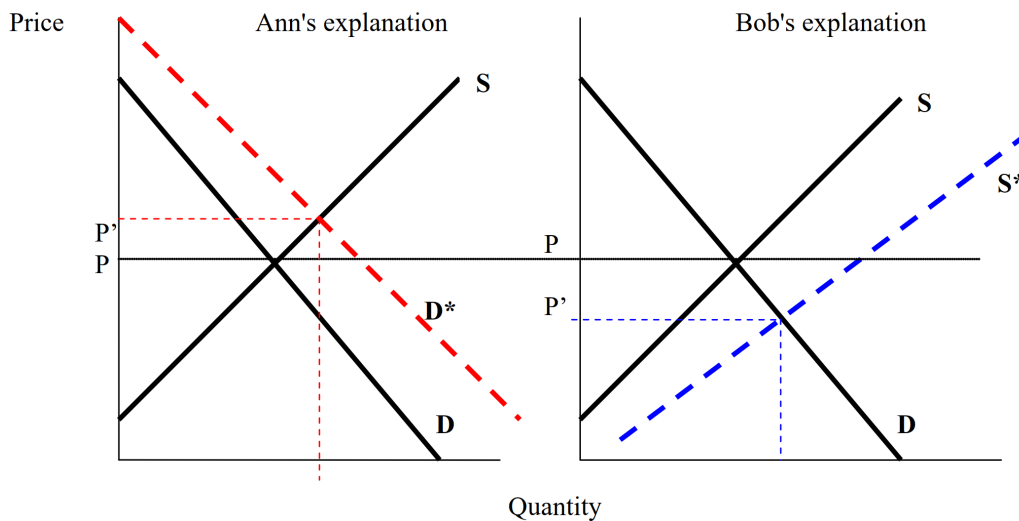

Figure 1: Competing explanations for the increase in drug use in supply-and-demand framework in Problem 1.

2. The key here is to find the *effective supply and demand curves* in each in the scenarios. All the prices are in euros per square meter, quantities in 1000's of square meters.

- (a) First we determine the equilibrium price at the current, *short-run fixed supply* of housing and *pre-pandemic demand*. Recall that in the equilibrium, price is such that the demand side is willing to buy the same quantity the supply side is willing to provide: $Q_0^D(p) = Q_0^S(p) \iff 12000 - 3500p = 5000 \implies p^* = 2$. As new houses are only built if $p > 2$, the current quantity is also the long-run equilibrium, $q^* = 5000$. Should the equilibrium price have been any higher, housing stock would've adjusted upwards.
- (b) In the short run, prices adjust but *supply is assumed fixed and therefore unchanged from (a)*, $q^* = 5000$. *Demand curve shifts upwards in the suburb* ($Q_0^D(p) \rightarrow Q_1^D(p)$) and we have $Q_1^D(p) = Q_0^S(p) \iff 12000 - 2000p = 5000 \implies p^* = 3\frac{1}{2}$ in the post-pandemic short-run equilibrium.

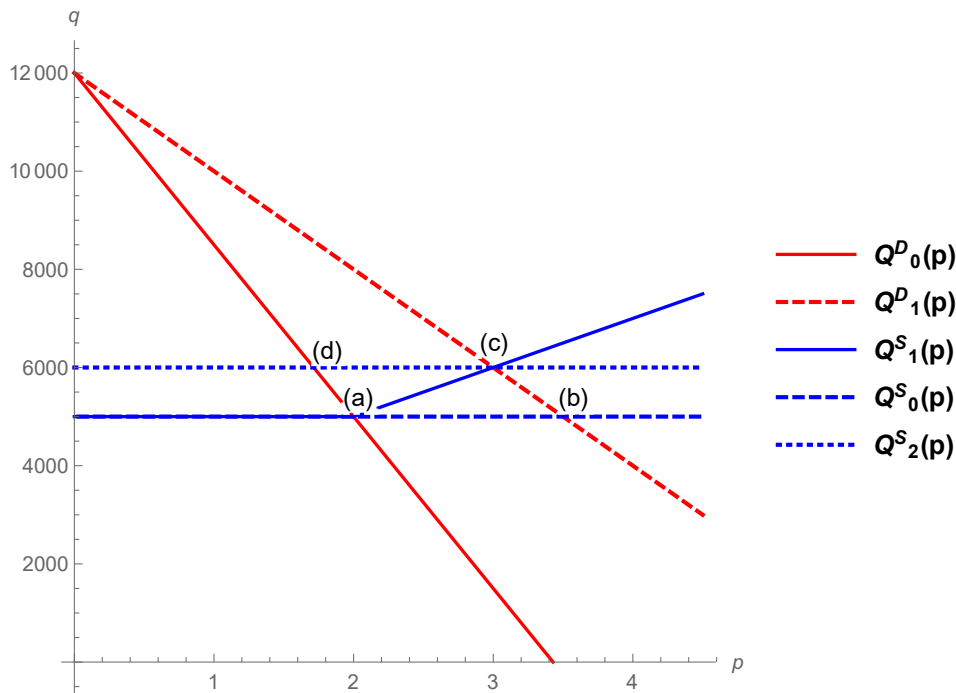

Figure 2: Supply and demand curves in the various scenarios of the housing market in Problem 2.

- (c) With the *post-pandemic increased demand*, short-run equilibrium price exceeds the threshold above which supply of housing will adjust in the long run, $p^* = 3\frac{1}{2} > 2$. With $p > 2$, $Q_1^S(p) = 5000 + 1000(p - 2)$, as the latter part of that equation is just for additional supply exceeding the fixed stock. It's pretty much our standard supply curve but as supply can only adjust upwards in reaction to price changes, we have a kink in the *long run supply curve* at $p = 2$, as seen in Figure 2 and

the familiar equivalence of supply and demand is written as $Q_1^D(p) = Q_1^S(p) \iff 12000 - 2000p = 5000 + 1000(p - 2) \implies p^* = 3$. Substitute this into demand curve to get $Q_1^D(p^*) = 12000 - 2000 * 3 \implies q^* = 6000$.

- (d) The pandemic induced boom in construction in the suburb *increased the inelastic short run supply* of housing from 5000 to 6000 ($(Q_0^S(p) \rightarrow Q_2^D(p))$). We're back with our *original demand curve* ($Q_1^D(p) \rightarrow Q_0^D(p)$) and the supply meets demand at $Q_0^D(p) = Q_2^S(p) \implies 12000 - 3500p = 6000 \implies p^* = \frac{12}{7}$.

3. In this exercise, all the quantities are in pallets per week and prices in euros per pallet. Consumer and supplier surpluses are measured in (pallets per week) \times (euros per pallet) = euros per week.

- (a) In the market equilibrium, the price is such that the amount producers are willing to supply equals the quantity the consumers are willing to purchase. That is, the equilibrium price p^* solves

$$\begin{aligned} Q^D(p^*) &= Q^S(p^*) \Leftrightarrow \\ 100 - 2p^* &= 4p^* - 20 \Leftrightarrow \\ p^* &= 20. \end{aligned}$$

Equilibrium quantity is found by plugging p^* into either the demand or the supply curve as these are equal in the equilibrium:

$$Q^* = Q^D(p^*) = Q^S(p^*) = 60.$$

In order to calculate the surpluses it's easiest to first invert the supply and the demand curves. In this way we can easily see the difference in costs (marginal costs for producers, price for consumers) and the gains (price for producers, willingness to pay for consumers) for each unit traded in the market. The inverse demand and supply curves are given by

$$\begin{aligned} p^D(Q) &= 50 - \frac{Q}{2} \\ p^S(Q) &= 5 + \frac{Q}{4}. \end{aligned}$$

Producer surplus therefore corresponds the triangular region between the supply curve and equilibrium price, whose area is given by

$$\begin{aligned} PS &= \frac{1}{2}(20 - 5)60 = 450, \\ CS &= \frac{1}{2}(50 - 20)60 = 900. \end{aligned}$$

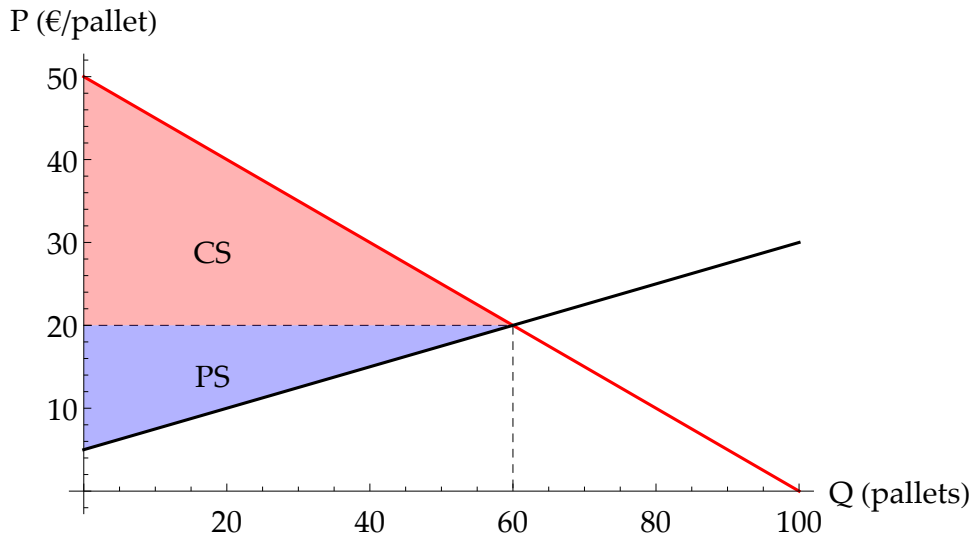

- (b) The market supply is the sum of individual suppliers' quantities. Since all the individual suppliers are identical, we can simply multiply the individual supplies by the number of suppliers to obtain the market supply:

$$Q^S(p) = 1000 \times ((p - 5)/250) = 4p - 20.$$

Since the supply is identical to 22a and the demand is unchanged, so are the equilibrium price and quantity as well surpluses.

- (c) The market supply is now given by

$$Q^S(p) = 500 \times ((p - 5)/250 + (p - 5)/150) = \frac{16}{3}(p - 5).$$

The market equilibrium is found by equating the market demand and the supply:

$$\begin{aligned} Q^D(p^*) &= Q^S(p^*) \Leftrightarrow \\ 100 - 2p^* &= \frac{16}{3}(p^* - 5) \Leftrightarrow \\ p^* &= \frac{190}{11} \approx 17.3 \implies Q^* = \frac{720}{11} \approx 65.5. \end{aligned}$$

At the equilibrium price, higher productivity firms supply $500(\frac{190}{11} - 5)/150 = \frac{450}{11}$ and therefore their share is $\frac{450}{11} / \frac{720}{11} = 5/8 = 62.5\%$.

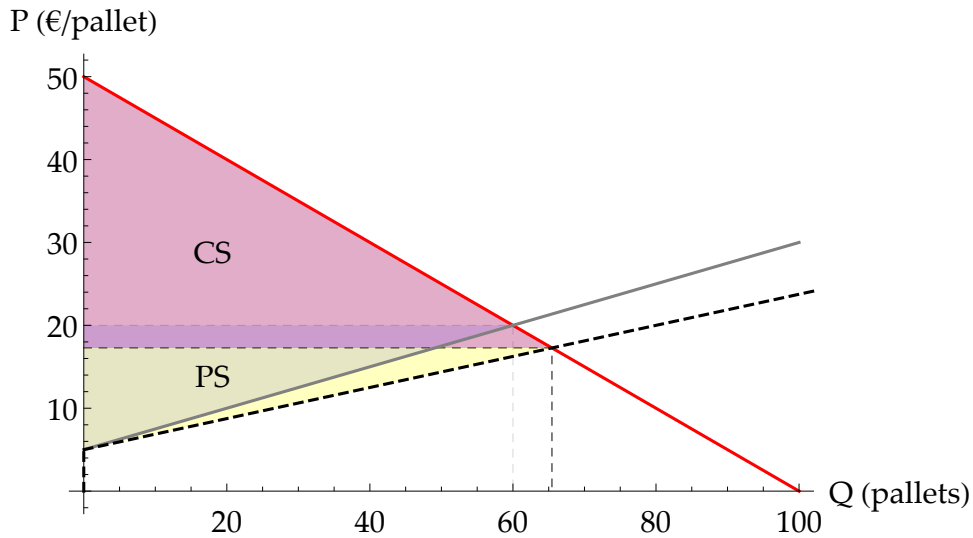

4. At any given price p , **market supply** is the aggregate amount that suppliers can push to the market at cost equal or less than p . Analogously, **market demand** at price p consists of all the units of, say, consumption that generate value higher than p .

In the equilibrium, price must be such that the supply side is willing to produce exactly the same amount as the demand side is willing to buy. If the price was higher, some of the suppliers would operate at deficit as the price would cover their costs. These suppliers would cease their production. Similarly, if the price was lower, new suppliers would enter the market.

Total expenditure equals equilibrium price times equilibrium quantity. By **consumer surplus** we mean the difference between your willingness to pay (reservation price) and the actual price you pay. **Producer surplus** is the difference between selling price and cost of producing (reservation price). To calculate the surpluses we'll employ **inverse demand and supply curves**. These essentially depict the same information as their direct counterparts but from a different perspective which allows for easy calculation of surpluses.

You can think about inverse demand curve $p^D(q)$ like this: order the consumed units from the one that gives the most satisfaction to the one that leaves the buyer indifferent between buying or not. Consumers pay the same price for each consumed unit and therefore consumer surplus is the area between inverse demand curve and equilibrium price.

Throughout this exercise, the supply remains the same and its inverse is

$$Q^S(p) = 15p - 6 \iff$$

$$p^S(Q) = \frac{Q}{15} + \frac{2}{5}.$$

All quantities in this exercise are in cubic meters (m^3) whereas prices, surpluses and expenditures are measured in euros (€). Demand differs between the subparts, see Figure 3.

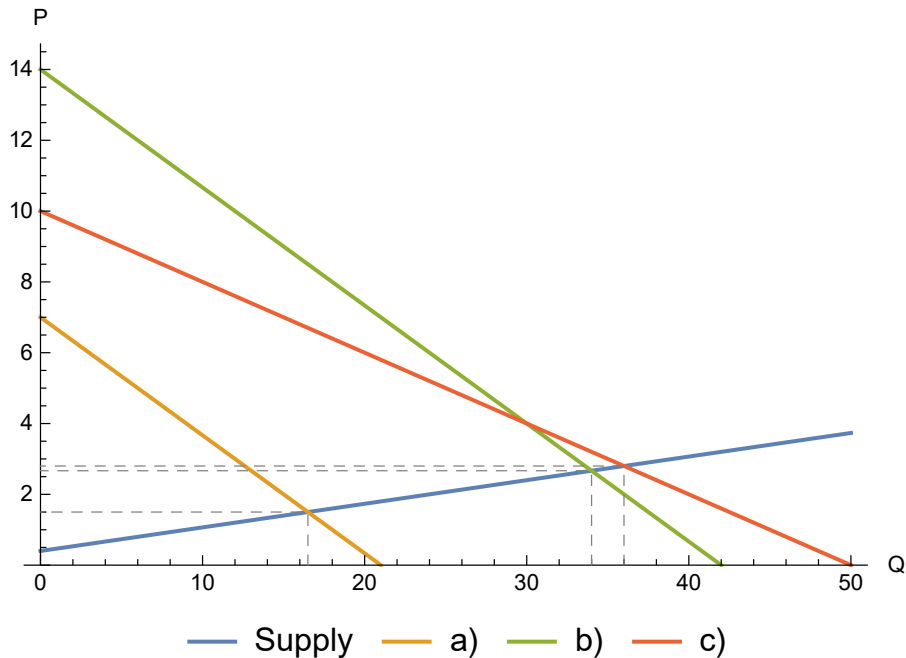

Figure 3: Demand in various parts of Problem 4.

(a) Inverse demand is

$$Q^D(p) = 21 - 3p \iff$$

$$p^D(Q) = -\frac{Q}{3} + 7.$$

The equilibrium price-quantity pair lies in the intersection of (inverse) demand and supply curves:

$$p^S(Q) = p^D(Q) \iff$$

$$\frac{Q}{15} + \frac{2}{5} = -\frac{Q}{3} + 7$$

$$Q^* = \frac{33}{2}$$

The equilibrium price can then be found by plugging in the equilibrium quantity q^* into either supply or demand curve:

$$p^* = \frac{\frac{33}{2}}{15} + \frac{2}{5} = \frac{3}{2}.$$

Total expenditure is $Q^*p^* = \frac{33}{2} \cdot \frac{3}{2} = \frac{99}{4} \approx 24.8$.

Consumer surplus is the triangular region between inverse demand curve and price:

$$CS = \frac{33}{2} \left(7 - \frac{3}{2} \right) / 2 = \frac{363}{8} \approx 45.4.$$

Producer surplus is the triangular region between inverse supply curve and price:

$$PS = \frac{33}{2} \left(\frac{3}{2} - \frac{2}{5} \right) / 2 = \frac{363}{40} \approx 9.1.$$

- (b) In this exercise we aggregate market demand from individual demands simply by multiplying the individuals' demands by the number of individuals:

$$Q^D(p) = 300 \left(\frac{7}{50} - \frac{p}{100} \right) = 42 - 3p$$

Following the same steps as before, inverse demand is

$$\begin{aligned} Q^D(p) &= 42 - 3p \iff \\ p^D(Q) &= -\frac{Q}{3} + 14. \end{aligned}$$

The equilibrium price-quantity pair lies in the intersection of (inverse) demand and supply curves:

$$\begin{aligned} p^S(Q) &= p^D(Q) \iff \\ \frac{Q}{15} + \frac{2}{5} &= -\frac{Q}{3} + 14 \\ Q^* &= 34 \end{aligned}$$

The equilibrium price can then be found by plugging in the equilibrium quantity q^* into either supply or demand curve:

$$p^* = \frac{34}{15} + \frac{2}{5} = \frac{8}{3}.$$

Total expenditure is $Q^*p^* = 34 \frac{8}{3} = \frac{272}{3} \approx 90.7$.

Consumer surplus is the triangular region between inverse demand curve and price:

$$CS = 34 \left(14 - \frac{8}{3} \right) / 2 = \frac{363}{8} \approx 192.7.$$

Producer surplus is the triangular region between inverse supply curve and price:

$$PS = \frac{33}{2} \left(\frac{3}{2} - \frac{2}{5} \right) / 2 = \frac{578}{15} \approx 38.5.$$

- (c) In this exercise, it requires some thought to come up with the demand curve. First notice that at $p = 10$, the quantity demanded goes to zero, $Q^D(10) = 0$. When $p = 0$, all the 500 buyers will buy $0.1m^3$ of goodies and therefore $Q^D(0) = 50$. In between,

the demand curve is linear - the reservation price is uniformly distributed in the interval, meaning that increasing the price drives away (on expectation) the same number of buyers at any price in the interval. Should we have any other distribution for the reservation price, the demand curve would take a non-linear shape. Now that we know two points on a linear demand curve, we know it's formula:

$$Q^D(p) = 50 - 5p \iff$$

$$p^D(q) = 10 - \frac{Q}{5}$$

The equilibrium price-quantity pair lies in the intersection of (inverse) demand and supply curves:

$$p^S(Q) = p^D(Q) \iff$$

$$\frac{Q}{15} + \frac{2}{5} = 10 - \frac{Q}{5}$$

$$Q^* = 36$$

The equilibrium price can then be found by plugging in the equilibrium quantity q^* into either supply or demand curve:

$$p^* = \frac{36}{15} + \frac{2}{5} = \frac{14}{5}.$$

Total expenditure is $Q^*p^* = 36 \frac{14}{5} = \frac{504}{5} = 100.8$.

Consumer surplus is the triangular region between inverse demand curve and price:

$$CS = 36(10 - \frac{14}{5})/2 = \frac{648}{5} \approx 129.6.$$

Producer surplus is the triangular region between inverse supply curve and price:

$$PS = \frac{33}{2}(\frac{3}{2} - \frac{2}{5})/2 = \frac{216}{5} \approx 43.2.$$

- (d) Constant elasticity of demand means that a similar relative change in price will cause the same relative change in quantity demanded at any price. To clarify this, think about a linear demand function. An absolute increase dp in price will have the same absolute effect dQ^D on quantity at any price given the constant slope. However, the same absolute increase means a smaller relative increase in price, dp/p , as price increases. Since demand decreases with price, the same absolute change in quantity demanded yields a bigger relative change in the quantity, dQ^D/Q^D at higher prices. As elasticity is defined as the ratio of these relative changes, $\epsilon^d = \frac{dQ^D/Q^D}{dp/p}$, it's clear that linear demand must have an increasing elasticity of demand.

In fact, constant elasticity requires the demand function to be of a specific form, namely $Q^D(p) = kp^{\epsilon^d}$, where k is some constant. This is easily verified:

$$\frac{dQ^D/Q^D}{dp/p} = \frac{dQ^D}{dp} \frac{p}{Q^D} = \epsilon^d kp^{\epsilon^d-1} \frac{p}{kp^{\epsilon^d}} = \epsilon^d.$$

Since we're given the elasticity and one point on the curve, we can solve for k :

$$10 = k5^{-\frac{3}{2}} \iff k = 50\sqrt{5},$$

and therefore our demand function stands as

$$Q^D(p) = 50\sqrt{5}p^{-\frac{3}{2}}$$

$$p^D(Q) = 5\left(\frac{10}{Q}\right)^{2/3}$$

Equilibrium quantity can again be found by equating demand and supply, but this

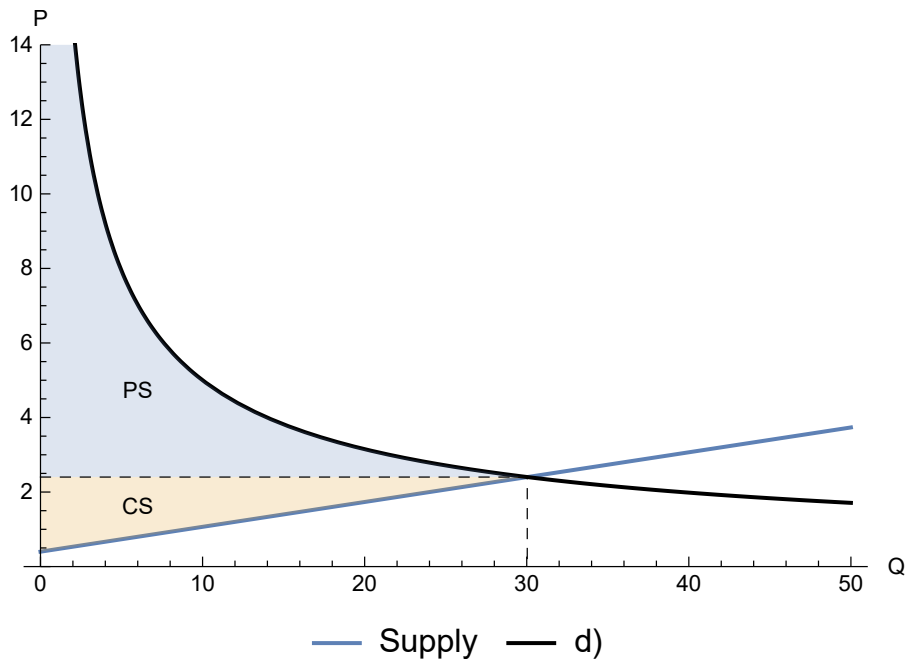

Figure 4: Isoelastic demand in part 4d.

time the solution is a numerical one:

$$p^S(Q) = p^D(Q) \iff$$

$$\frac{Q}{15} + \frac{2}{5} = 5\left(\frac{10}{Q}\right)^{2/3}$$

$$Q^* \approx 30.03$$

We obtain the equilibrium price in a familiar fashion:

$$p^* = \frac{30.03}{15} + \frac{2}{5} \approx 2.40.$$

Total expenditure is $Q^*p^* = 30.03 \times 2.40 \approx 72.1$.

Unlike with linear demand, where one can employ geometry, we must resort to integration (which is an option with linear functions as well) now that we have curvature in the demand function.

$$CS = \int_0^{30.03} 5\left(\frac{10}{Q}\right)^{2/3} - 2.40 \, dQ = 15 \times 10^{2/3} 30.03^{1/3} - 30.03 \times 2.40 \approx 144.3.$$

Producer surplus is the triangular region between inverse supply curve and price:

$$PS = 30.03\left(2.40 - \frac{2}{5}\right)/2 = \frac{216}{5} \approx 30.1.$$

5. (a) We know two things about the electricity market shock in Druidia: firstly, that price has doubled and secondly, that a quarter of the quantity supplied at the previous equilibrium price has left the market. The decrease in supply shifts the supply curve to the left. There is no change in demand. This can, for example, be depicted as in Figure 5. Price doubles from $p^* = 2$ in the initial equilibrium to $p^{**} = 4$ in the new equilibrium. The decrease in supply causes the supply curve to shift a quarter of initial equilibrium output, $q^* = 8$, to the left. This causes a decrease in equilibrium output, shown in the figure.

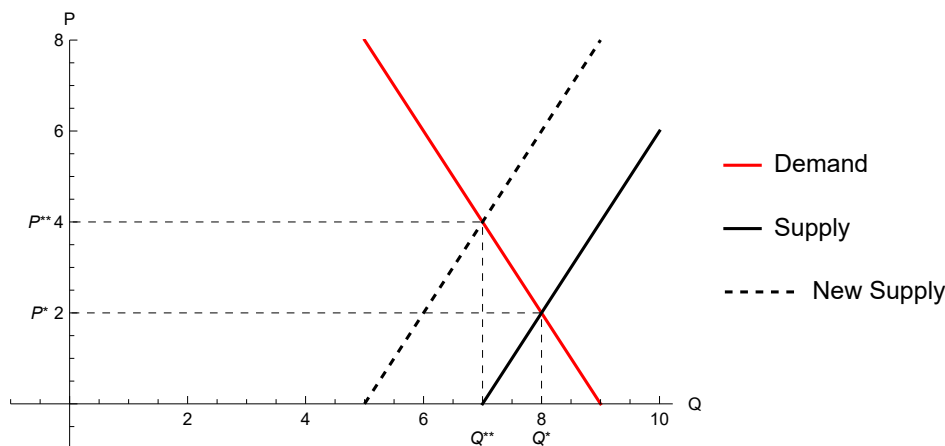

Figure 5: Example solution for 5a.

Note: There are many different combinations of demand and supply curves that are consistent with the information we have. We know that the equilibrium price doubles while the supply shifts left in such a way that the quantity supplied on the new supply curve is 75% of the original quantity when evaluated at the original equilibrium price.

Only the amount of electricity that was imported—the previous equilibrium quantity q^* —was observed at price p^* . We don't know how much electricity exactly Landia would have exported at other prices. In figure 5, to make the drawing as simple as possible, we assumed that the new supply curve is parallel to the old one, but it wouldn't have to be parallel as long as it goes through the point $\{q = 6, p = 2\}$ and is everywhere to the left of the original supply curve.

- (b) This silly policy would make no difference to any real quantity. Sellers' reservation prices are defined for the price they actually get. Baldrick proposed that the final prices that sellers get are to be scaled downwards by 0.9 relative to the ordinary market mechanism, so they will scale their reported reservation prices up by $1/0.9$. Similarly for buyers. Nothing in Baldrick's cunning plan changes anything real about either supply or demand. The only resulting change would be a reported administrative price, which would be a multiple $1/0.9$ of the actual market price.
6. A normal porcini crop is 26 tons that is sold at price 3 €/kg. Now, an unusually rainy summer increases the crop to 32 tons, causing the price to drop to 2.5€/kg.
- (a) Based on these two observations, give a back-of-the-envelope estimate for the demand elasticity of porcini.

First, denote the normal crop by Q_1 and unusually productive crop Q_2 and corresponding prices as P_1 and P_2 . We have:

$$\begin{aligned} Q_1 &= 26 \\ Q_2 &= 32 \\ P_1 &= 3 \\ P_2 &= 2.5 \end{aligned}$$

To make back-of-the-envelope estimate of demand elasticity, denoted by ϵ_D , we use the mid-point method and use these two quantity-price pairs. Mid-point method measures the relative changes of quantities and prices and uses the mid-point of the two observations as a reference point:

$$\epsilon_D = \frac{\frac{(Q_2 - Q_1)}{((Q_2 + Q_1)/2)}}{\frac{(P_2 - P_1)}{((P_1 + P_2)/2)}}$$

Inserting the observations, we get:

$$\epsilon_D = \frac{\frac{(32 - 26)}{((32 + 26)/2)}}{\frac{2.5 - 3}{((2.5 + 3)/2)}} \approx -1.138$$

This is the demand elasticity, which is negative as a price increase lowers demand.

- (b) New government plants to cut down visas for seasonal mushroom hunters and specialists estimate that this means that a normal crop drops to 22 tons. Using the elasticity estimate in a.) give a back-of-the-envelope estimate for the impact of the policy on porcini price and total porcini revenue.

We have now a specialist estimate that a normal porcini crop drops from 26 to 22. Denote this change, $Q_1 = 26$ and $Q_2 = 22$. We know that $P_1 = 3$ but we do not know P_2 . We can use the estimate for the demand elasticity to calculate P_2 . For approximation, we can use the mid-point definition of demand elasticity, stating that:

$$\epsilon_D = \frac{\frac{Q_2 - Q_1}{((Q_1 + Q_2)/2)}}{\frac{P_2 - P_1}{((P_1 + P_2)/2)}}$$

We can then use this relationship to get:

$$\frac{(P_2 - P_1)}{((P_1 + P_2)/2)} = \frac{\frac{Q_2 - Q_1}{((Q_1 + Q_2)/2)}}{\epsilon_D}$$

Inserting the observations and estimate for the elasticity, we get:

$$\frac{(P_2 - P_1)}{((P_1 + P_2)/2)} = \frac{(22 - 26)/((26 + 22)/2)}{-1.138} \approx 0.146 = 14.6\%$$

Price increases approximately 14.6% as a result to the policy change.

For porcini revenue, we can use the the following relationship (derivation is presented in the lecture notes) for firm revenue and demand elasticity, answering how much revenue changes when there is a small change in price:

$$\frac{(R_2 - R_1)}{((R_1 + R_2)/2)} = \frac{(P_2 - P_1)}{((P_1 + P_2)/2)} \times (1 + \epsilon_D)$$

where R is revenue. Inserting the numbers, we get:

$$\frac{(R_2 - R_1)}{((R_1 + R_2)/2)} = 0.146 \times (1 + (-1.138)) = 0.135 \times (-0.138) \approx -0.02 = -2.0\%.$$

So the revenue drops 2.0 percent as a result.

In 6b it is also acceptable to use the relative change definition of demand elasticity. Using this method, we get that revenue drops 1.9 percent.

7. (a) Initially the market is in equilibrium, both from the short run and the long run point of view. The equilibrium price p^* solves

$$\begin{aligned} Q^D(p) &= Q_{LR}^S(p) \Leftrightarrow \\ 100 - p &= 2p - 20 \implies \\ p^* &= 40. \end{aligned}$$

From this it follows that

$$q^* = Q^D(p^*) = Q_{LR}^S(p^*) = 60.$$

The equilibrium capacity x^* is equal to q^* by definition, thus $x^* = 60$. Figure 6 shows the initial market situation.

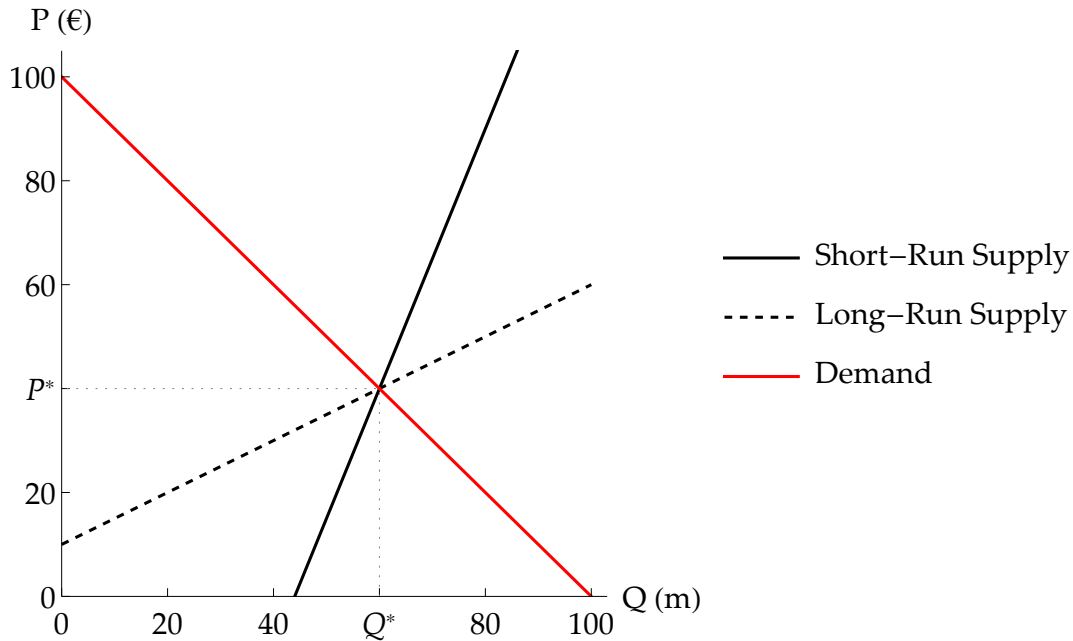

Figure 6: Initial market situation in part 7a.

- (b) The doubling of demand means that the quantity demanded is doubled at every price. This could mean, for example, that there are now twice as many buyers, but drawn from the same population as before.

$$Q_{new}^D(p) = 2Q^D(p) = 2(100 - p) = 200 - 2p$$

Given the equilibrium capacity from before, the short run supply can be exactly defined.

$$\begin{aligned} P_{SR}^S(q) &= P_{LR}^S(q) + 2(q - x) \\ &= \frac{1}{2}q + 10 + 2(q - 60) \\ &= \frac{5}{2}q - 110 \Leftrightarrow \\ Q_{SR}^S(p) &= \frac{2}{5}p + 44. \end{aligned}$$

The new short-run equilibrium can be solved as follows:

$$\begin{aligned} Q_{new}^D(p) &= Q_{SR}^S(p) \Leftrightarrow \\ 200 - 2p &= \frac{2}{5}p + 44 \implies \\ p_{SR}^* &= 65 \implies q_{SR}^* = 70. \end{aligned}$$

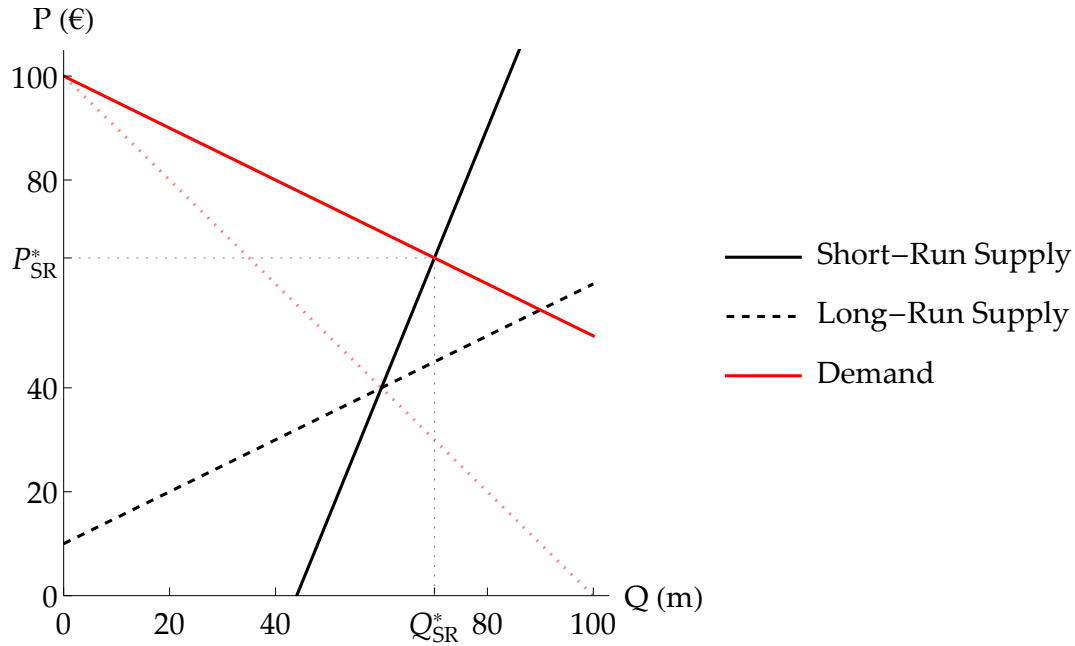

Figure 7: Temporary market situation after the doubling of demand 7b.

- (c) When capacity adjusts, the market equilibrium can be solved using the long run supply, as in part 7a.

$$\begin{aligned} Q_{new}^D(p) &= Q_{LR}^S(p) \Leftrightarrow \\ 200 - 2p &= 2p - 20 \implies \\ p_{LR}^* &= 55 \implies q_{LR}^* = 90. \end{aligned}$$

The short run supply is adjusted and the new situation is showed in Figure 8.

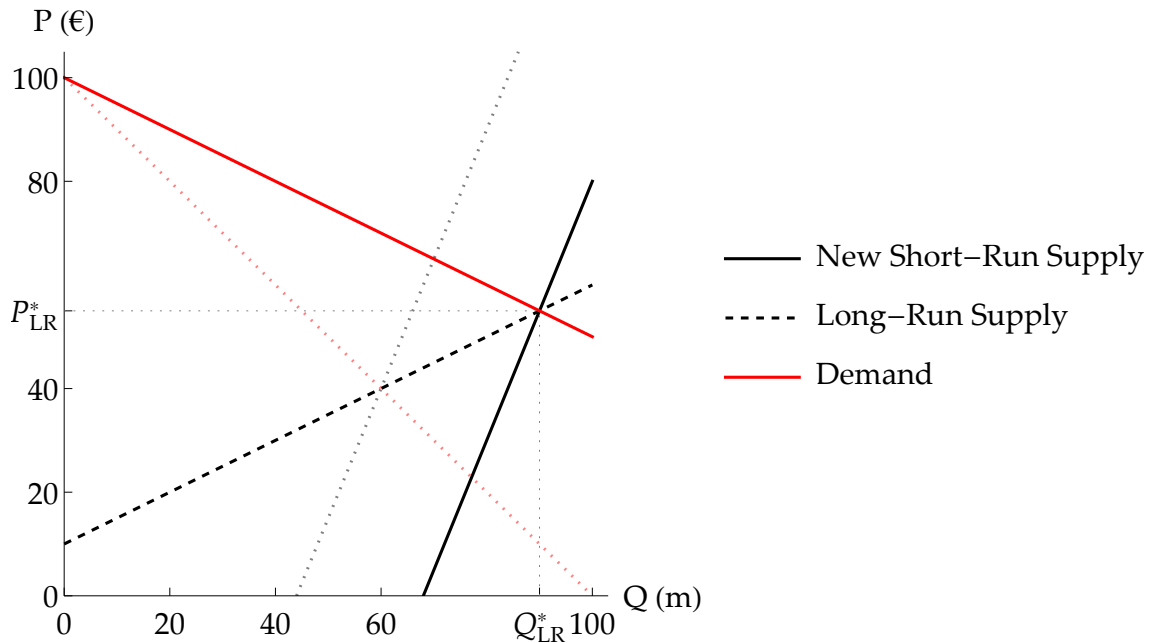

Figure 8: New market situation after the supply side has adjusted to the new demand in part 7c.

8. All quantities in this exercise are in *barrels* whereas prices, surpluses, and revenues are measured in *monetary units*.
- (a) We start with solving for the equilibrium before those strange events. In the equilibrium, the quantity supplied must equal the quantity demanded. We solve first for equilibrium price and plug that into the demand curve to obtain the equilibrium quantity whereas total revenue equals the product of these two:

$$\begin{aligned}
 25 - 0.25p &= 0.2p - 2 \iff \\
 p^* &= 60 \implies \\
 Q^* &= 25 - 0.25p^* = 10 \implies \\
 R &= p^*Q^* = 600
 \end{aligned}$$

After the strange events, demand curve reads as $\tilde{Q}^D = 2Q^D = 50 - 0.5p$. Equilibrium is found in a usual fashion:

$$\begin{aligned}
 50 - 0.5p &= 0.2p - 2 \iff \\
 \tilde{p}^* &= \frac{520}{7} \approx 74.3 \implies \\
 \tilde{Q}^* &= 50 - 0.5\tilde{p}^* = \frac{90}{7} \approx 12.9 \implies \\
 \tilde{R} &= \tilde{p}^*\tilde{Q}^* \approx 955
 \end{aligned}$$

Price therefore increases by $\frac{74.3-60}{60} = 23.8\%$, quantity traded by $\frac{12.9-10}{10} = 28.6\%$ and total revenue by $\frac{955-600}{600} = 59.2\%$.

- (b) Right before the shock, the supply is $Q^S(p) = 0.2p - 2$. After the first month the supply has increased to $Q_1^S(p) = Q^S(p) \times 1.2 = (0.2p - 2)1.2$ and after the n^{th} month to $Q_n^S(p) = Q^S(p) \times 1.2^n = (0.2p - 2)1.2^n$.

After n^{th} month period, the market clears at

$$50 - \frac{p}{2} = \left(\frac{p}{5} - 2\right)\left(\frac{6}{5}\right)^n \iff$$

$$\tilde{p}_n^* = \frac{50 + 2\left(\frac{6}{5}\right)^n}{\frac{1}{2} + \frac{6^n}{5^{n+1}}} \implies$$

$$\tilde{Q}_n^* = 50 - \frac{25 + \left(\frac{6}{5}\right)^n}{\frac{1}{2} + \frac{6^n}{5^{n+1}}}$$

It'd be equally fine to solve the equilibrium for every n individually, but solving the equilibrium for any n lets us to just plug in n to find the equilibrium. This is the recommended and effort-saving way to proceed in problems where the same problem must be solved for multiple parameter values, for instance.

$\tilde{p}_1^* = 70.8$	$\tilde{Q}_1^* = 14.6$	$\tilde{R}_1 = 1033$
$\tilde{p}_2^* \approx 67.1$	$\tilde{Q}_2^* \approx 16.4$	$\tilde{R}_2 \approx 1103$
$\tilde{p}_3^* \approx 63.2$	$\tilde{Q}_3^* \approx 18.4$	$\tilde{R}_3 \approx 1163$
$\tilde{p}_4^* \approx 59.2$	$\tilde{Q}_4^* \approx 20.4$	$\tilde{R}_4 \approx 1208$

That is, after four months the increase in supply has pushed the prices below the pre-strangeness level. Notice that revenue reacts quite lazily to the changes since the price and the quantity move to opposite directions. Our final supply curve is therefore $\hat{Q}^S(p) = (0.2p - 2)1.2^4$. Lastly, we calculate the equilibrium with the original demand and the newly obtained supply:

$$25 - 0.25p = (0.2p - 2)1.2^4 \iff$$

$$\hat{p}^* = \frac{850}{21} \approx 40.5 \implies$$

$$\hat{Q}^* = 25 - 0.25\hat{p}^* \approx 14.0 \implies$$

$$\hat{R} = \hat{p}^*\hat{Q}^* \approx 567.$$

9. In this exercise, all the quantities are MWh and prices in euros per MWh.

- (a) We must first figure out the market supply. When the price is above 800, every plant can operate profitably and therefore the market supply is 8000. Below that, when market price is increased by one euro, a constant $4000/800 = 5$ is gained in supply.

Therefore the market supply is:

$$Q_N^S(p) = \begin{cases} 4000 + 5p, & 0 \leq p < 800 \\ 8000, & p \geq 800 \end{cases} \Leftrightarrow$$

$$p_N^S(Q) = \begin{cases} 0, & Q \leq 4000, \\ -800 + Q/5, & 4000 \leq Q < 8000 \\ \infty, & Q \geq 8000. \end{cases}$$

Note that there is no supply beyond 8000 regardless of the price so the inverse supply curve becomes a vertical line.

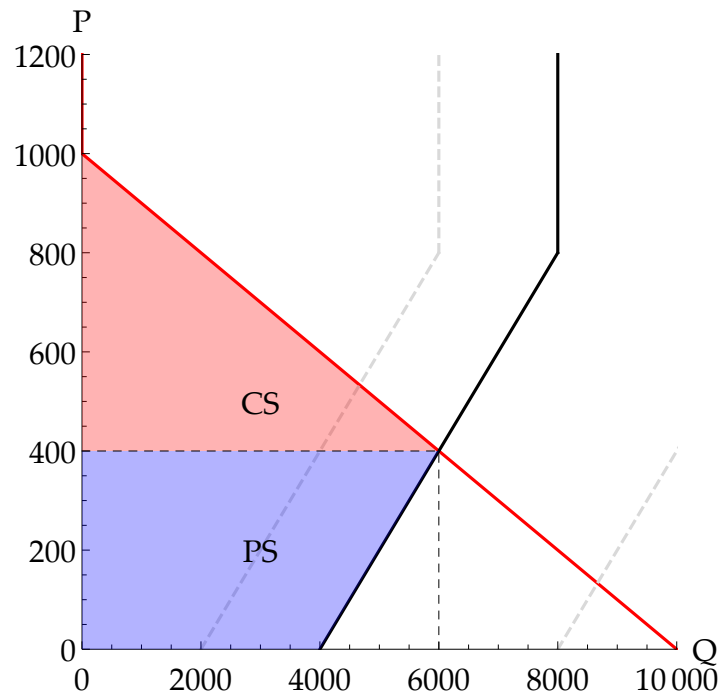

Figure 9: Market equilibrium in 9a.

Market demand is obtained by aggregating the individual buyers' demands:

$$Q^D(p) = 1000(10 - p/100) = 10000 - 10p \Leftrightarrow$$

$$p^D(Q) = 1000 - q/10.$$

In the equilibrium, supply equals demand. Let's first try to find the solution from the non-flat part of the supply curve.

$$Q^D(p^*) = Q^S(p^*) \Leftrightarrow$$

$$10000 - 10p^* = 4000 + 5p^* \Leftrightarrow$$

$$p^* = 400 \implies Q^* = 6000.$$

The equilibrium price actually lies on the upwards sloping part. If it didn't we should find the solution from the flat part starting at $p = 800$. When supply and demand curves are defined piecewise it is often easiest to graph them first to see in which "piece" the equilibrium point is located.

- (b) Depending on the day, the constant term (wind farms' supply) in the supply curve is altered while the supply form other plants remains the same. The market supplies on a low wind day and a high wind day are

$$Q_L^S(p) = \begin{cases} 2000 + 5p, & 0 \leq p < 800 \\ 6000, & p \geq 800 \end{cases} \Leftrightarrow$$

$$p_L^S(Q) = \begin{cases} 0, & Q \leq 2000, \\ -400 + Q/5, & 2000 \leq Q < 6000 \\ \infty, & Q \geq 6000. \end{cases}$$

$$Q_H^S(p) = \begin{cases} 8000 + 5p, & 0 \leq p < 800 \\ 12000, & p \geq 800 \end{cases} \Leftrightarrow$$

$$p_H^S(Q) = \begin{cases} 0, & Q \leq 8000, \\ -1600 + Q/5, & 8000 \leq Q < 12000 \\ \infty, & Q \geq 10000. \end{cases}$$

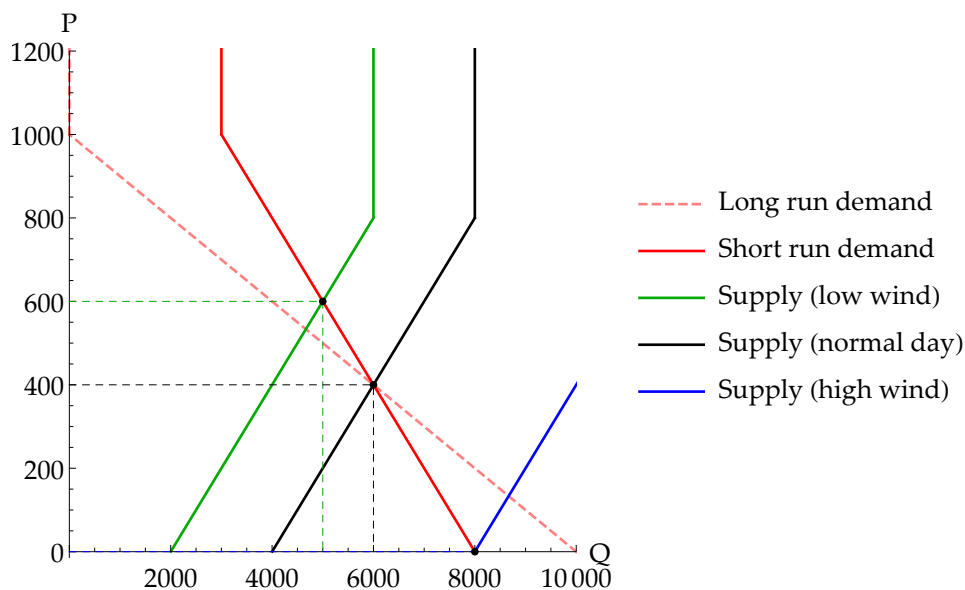

Figure 10: Market equilibrium in the various scenarios of 9b.

Half of the consumers have a fixed price contract. Their demand is unaffected by the market price and constant at $Q_{FP}^D(p) = 500(10 - 400/100) = 3000$. Regardless of the market price, demand will be at least this amount. The other half has demand dependent on the market price $Q_{MP}^D(p) = 500(10 - p/100) = 5000 - 5p$ so the market demand is

$$Q^D(p) = Q_{FP}^D(p) + Q_{MP}^D(p) = \begin{cases} 8000 - 5p, & 0 \leq p < 1000 \\ 3000, & p \geq 1000 \end{cases} \Leftrightarrow$$

$$p^D(Q) = \begin{cases} \infty & 0 \leq Q < 3000 \\ 1600 - Q/5, & Q \geq 3000. \end{cases}$$

Now that we've derived the supply and demand curves, finding the equilibrium is straightforward. We equate demand and supply in low, normal and high wind day, respectively:

$$Q^D(p_L^*) = Q_L^S(p_L^*) \Leftrightarrow$$

$$8000 - 5p_L^* = 2000 + 5p_L^* \Leftrightarrow$$

$$p_L^* = 500 \implies Q_L^* = 5000.$$

$$Q^D(p_N^*) = Q_N^S(p_N^*) \Leftrightarrow$$

$$8000 - 5p_N^* = 4000 + 5p_N^* \Leftrightarrow$$

$$p_N^* = 400 \implies Q_N^* = 6000$$

$$Q^D(p_H^*) = Q_H^S(p_H^*) \Leftrightarrow$$

$$8000 - 5p_H^* = 8000 + 5p_H^* \Leftrightarrow$$

$$p_H^* = 0 \implies Q_H^* = 8000.$$

(c) By similar reasoning as in 9a, the supply in a low wind day is given by

$$Q_N^S(p) = \begin{cases} 2000, & 0 \leq p < 400 \\ 5p, & 400 \leq p < 800 \\ 4000, & p \geq 800. \end{cases}$$

That is, there's a capacity of 2000 which has zero marginal cost and therefore supplied to the market at any positive price. We now gain new suppliers only when price is increased in the interval $[400, 800)$, again at a constant rate due to uniform distribution.

To find the requested equilibria, we equate our new supply with demand with fixed price contracts and market prices, respectively:

$$\begin{aligned}
 Q^D(p_{FP}^*) &= Q_L^S(p_{FP}^*) \Leftrightarrow \\
 8000 - 5p_{FP}^* &= 5p_{FP}^* \Leftrightarrow \\
 p_{FP}^* &= 800 \implies Q_{FP}^* = 4000.
 \end{aligned}$$

$$\begin{aligned}
 Q^D(p_{MP}^*) &= Q_L^S(p_{MP}^*) \Leftrightarrow \\
 10000 - 10p_{MP}^* &= 5p_{MP}^* \Leftrightarrow \\
 p_{MP}^* &\approx 667 \implies Q_{MP}^* \approx 3333.
 \end{aligned}$$

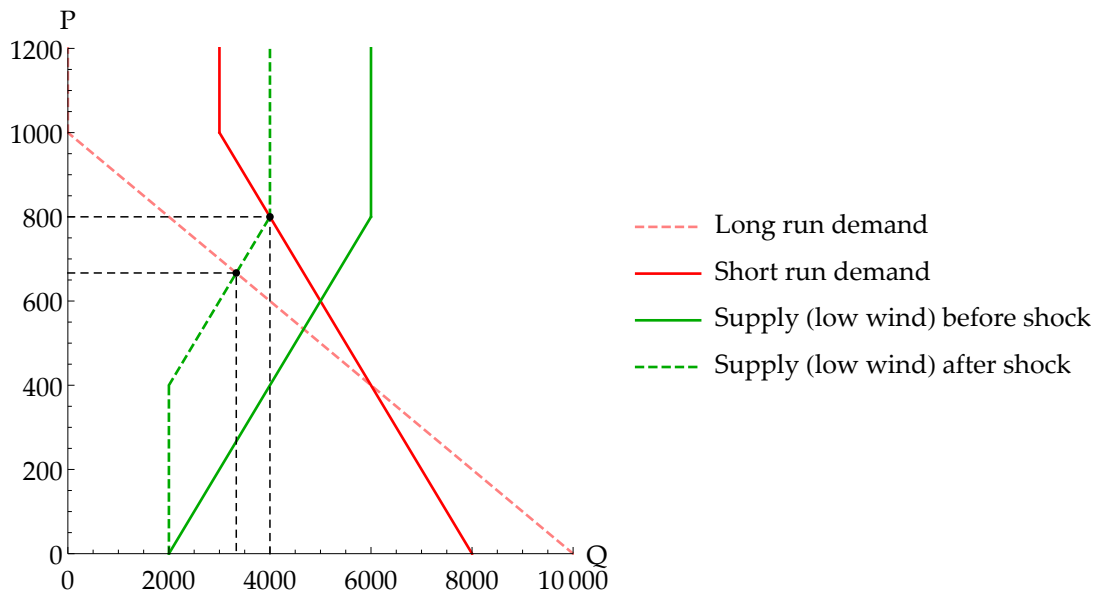

Figure 11: Market equilibrium in 9c.

10. (a) The fact that the price of housing is much higher in Centria than in Peripharia means that there are more households that strongly prefer to live in Centria than there is housing in Centria. If this were not the case some would move to Peripharia, where more housing would be supplied quite easily since supply there is elastic.
- (b) Both districts face a positive demand shock so prices increase in both districts. Since supply is inelastic in Centria the price increase is likely to be higher there.
- (c) The possibility of moving out of the high-price district (Centria) gives the households there a substitute for the good that is in short supply (housing in Centria). This can only make the demand for housing in Centria less elastic than in the absence of moving, so the price rise will be less than in part 10b.

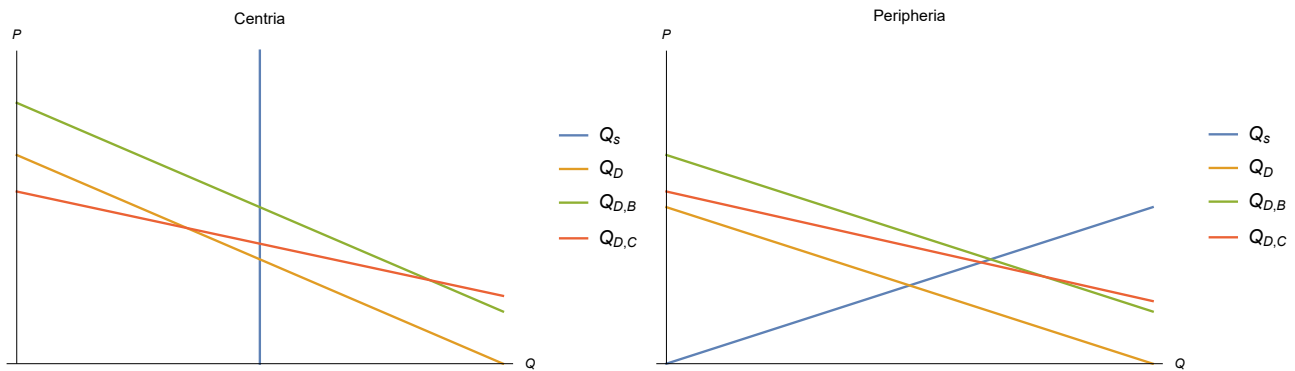

Figure 12: Positive demand shock in Centria (left) and Peripharia (Right) in 10b.

11. (a) The surplus generated by the market, S , is defined as the difference between aggregate valuation of the current owners, V_0 , and that of new owners, V_1 . That is, $S = V_1 - V_0$.

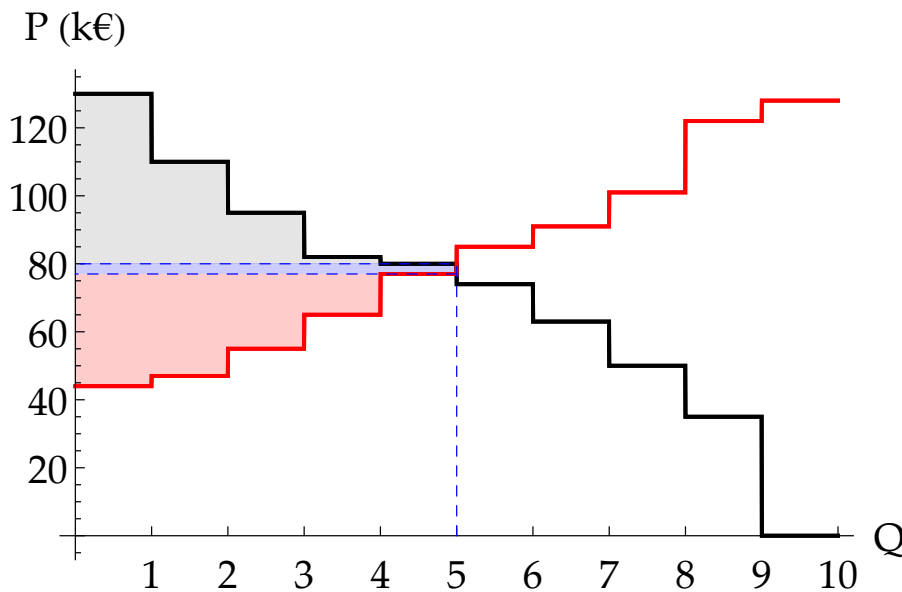

Figure 13: Market equilibrium in 11a.

Maximum surplus is attained when the cottages are allocated to households who value them most. We don't know the exact valuation of every household. We can write $V_0 = 44 + 47 + 55 + 65 + 77 + 85 + 91 + 101 + 122 + 128 + 4\bar{V} = 815 + \bar{V}$, where \bar{V} is the total valuation of those five households who have valuation in excess of 150 k€. These households, however, already own a cottage and should own one after trading as well since they have the highest five valuations of all households. To maximize the surplus, the remaining ten cottages should be allocated to households with valuations 130,128,122,110,101,95,91,85,82 and 80

which sum up to 1024. Therefore we can write $V_1 = 1024 + \bar{V}$ and subsequently $S = V_1 - V_0 = 1024 + \bar{V} - (815 + \bar{V}) = 209 \text{ k€}$.

- (b) In part 11a we derived the optimal allocation of cottages. There's no way bettering the first-best by introducing some handicaps to the market as we do in this exercise. Therefore the surplus generated by the divided market is at most equal to the unified market.

Consider, for instance, that the buyers are much more likely to buy in the early summer whereas sellers activate in the late summer. It could well be the case that there isn't a single seller when there are buyers and vice versa, and zero surplus and trades take place.

Note that we can have the same number of trades taking place whereas surplus remains smaller. For instance, if everyone else would be active in the early summer except a single seller with valuation of 44 and a single buyer with a valuation of 50 who leave it to late summer. Clearly these two will trade, and there will be one trade less in the early summer market compared to the unified market since that one seller is missing. The total number of trades will remain the same but one cottage will end up to a household with a comparably low valuation of 50 k€.

- (c) Now every household with a valuation exceeding $(20 + 40) = 60 \text{ k€}$ should optimally have a cottage after trading and construction. The valuations of these households are, in addition of those five with high valuation, 130, 128, 122, 110, 101, 95, 91, 85, 82, 80, 77, 74, 65 and 63 which sum up to 1303. Four new cottages will be build which will cost $4 \times 60 = 240 \text{ k€}$. Therefore the surplus generated is $S = 1303 + \bar{V} - 240 - (815 + \bar{V}) = 248 \text{ k€}$.
12. (a) By allowing the buyers and sellers to meet, online market platform enables that the products are allocated to those market participants that value them the most. For example, some of the sellers have relatively low valuations for the good, such as 45 or 55, whereas some buyers have very high valuations. In order to calculate the surplus that can be exhausted in this market, we can organize buyers and sellers by their valuations, which reflects seller's reservation price and buyer's willingness to pay.

We can calculate total surplus by calculating the differences in valuations between highest valuations of buyers and lowest valuations of sellers. For a trade to occur, seller's valuation needs to be lower than buyer's and price needs to be such that the trade is feasible for both participants. Price does not influence total surplus but only how the surplus is divided between buyer and seller.

One way to calculate total surplus is by rearranging valuations (from lowest to highest for sellers and from highest to lowest for buyers) and taking the difference of

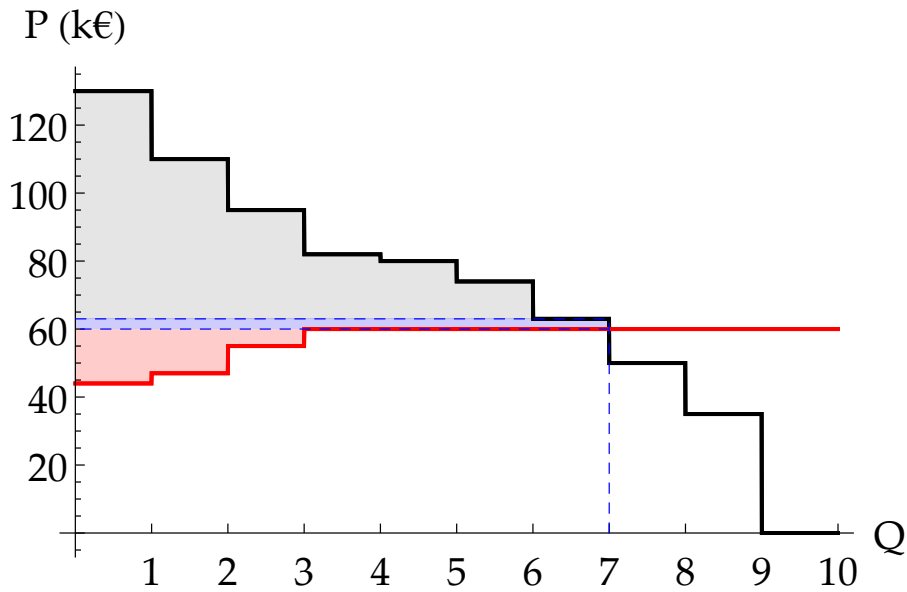

Figure 14: Market equilibrium in 11c.

highest differences in valuations. This is analogous of calculating the area of triangles in inverse demand-supply framework. We can illustrate this by drawing the inverse demand and supply curves with these discrete valuations:

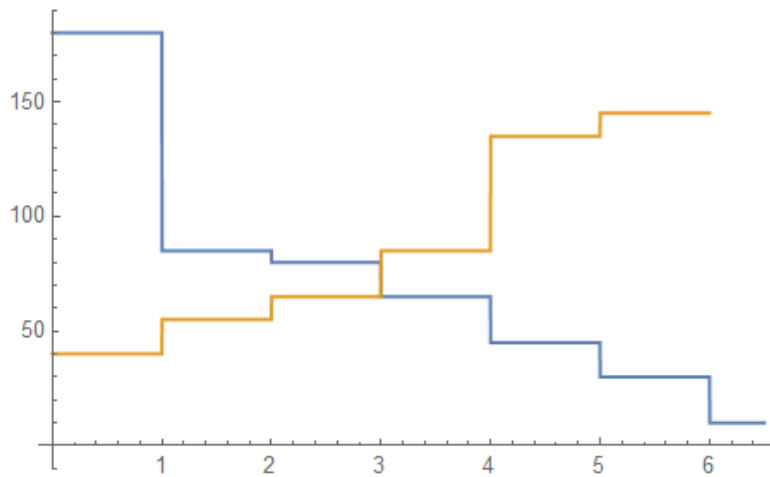

Figure 15: Buyers' and sellers' valuations for vinyl records in 12a.

Total surplus that can be exhausted in this market is then:

$$180 - 40 = 140$$

$$85 - 55 = 30$$

$$80 - 65 = 15$$

A total of 185 € of surplus is generated from three trades. These trade take place because trading allocates goods from those who value them the least to those who value them the most.

After trading, the valuations are:

sellers: {80, 85, 85, 135, 145, 180} and

buyers: {10, 30, 40, 45, 55, 65, 65}

No trade occurs in this allocation because buyer with the highest valuation has lower willingness to pay than seller with the lowest reservation price. Trading continues until the allocation is Pareto efficient, which by definition means that nobody can be made better off without making someone worse off. Therefore, the allocation is pareto-efficient. This result is know as the first theorem of welfare economics, guaranteeing that that the market has exhausted all gains from trade.

- (b) No. A Pareto efficient allocation ensures that all the gains from trade are exhausted and nobody can benefit from trade. Sequential trading does not matter as the market in 12a has exhausted all the surplus available. This result follows from the first theorem of welfare economics. Another way to think about the question is to imagine any ordering of trades happening but after trades take place the best possible allocation is the allocation in 12a as it is pareto efficient. The total surplus from going from the initial allocation to the pareto efficient allocation is, the same as in 12a).
- (c) We can think this problem in two ways. We can think about valuations of either sellers or buyers conditional on trade. We can think that the buyer pays the mailing cost as the trade happens, implying that the value that the buyer receives from the good is 10€ less when the trade happens. In other words, the buyers' willingness to pay decreases by 10 €. In this case, the valuations conditional on trade are:
sellers: {40, 55, 65, 85, 135, 145} and
buyers: {0, 20, 35, 55, 70, 75, 170}.

In this scenario, we can redo the analysis in 12a and calculate the differences in valuations:

$$170 - 40 = 130$$

$$75 - 55 = 20$$

$$70 - 65 = 5$$

The total surplus that the three trades generate is 155€ so the cost lowers surplus by 10€ per trade. We illustrate this in Figure 16. We can see from the graph that the transaction cost squeezes surplus exactly 10€ per trade. However, the cost does not affect the number of trades because of the valuations in the initial allocation.

Another way to approach the mailing cost is to assume that the seller pays the cost. In this case, the reservation price for the seller is 10€ higher because she needs to

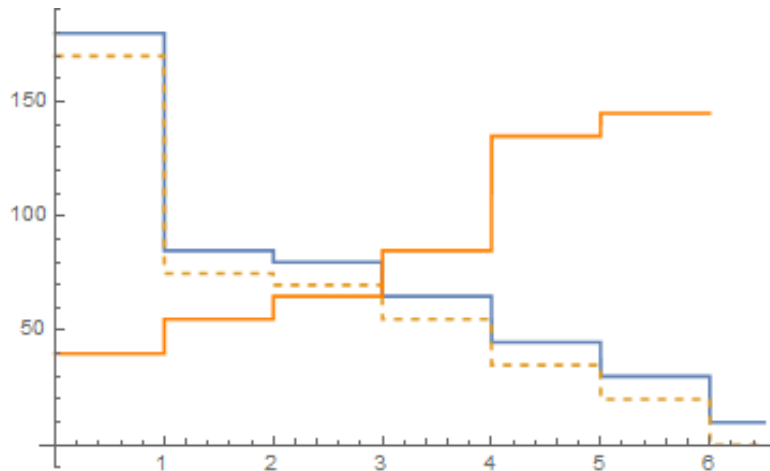

Figure 16: Buyers' and sellers' valuations after a transaction cost (buyer pays) in 12c.

pay 10€ for mailing costs. Now the buyer has willingness to pay that corresponds to valuation but sellers have 10 € higher reservation prices:

sellers: {50, 65, 75, 95, 145, 155}

buyers: {10, 30, 45, 65, 80, 85, 180}

These are illustrated in Figure 17.

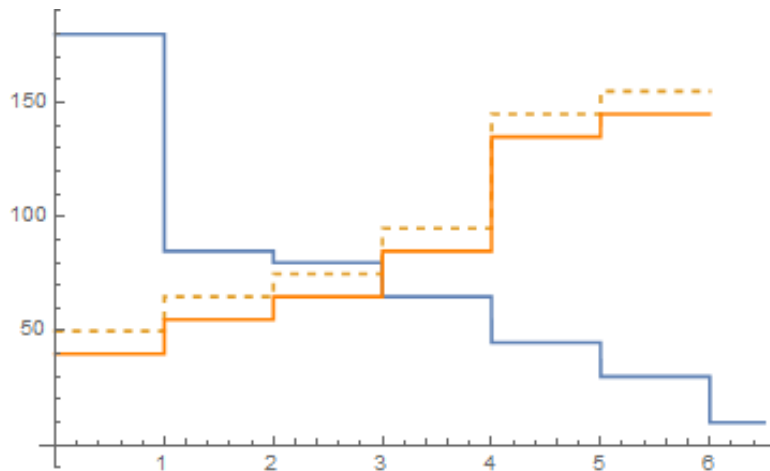

Figure 17: Buyers' and sellers' valuations after a transaction cost (seller pays) in 12c.

13. (a) The market clears (i.e. the quantity demanded equals the quantity supplied) at any price $p \in [1880, 1999]$ due to a vertical portion in the (inverse) demand curve. In accordance with the tie-breaking rules, we pick the lowest of these prices, $p^* = 1880$ €/MWh. The equilibrium quantity is 10.97 GWh.
- (b) Now we have a counterfactual situation where supply is increased by 0.1 GWh for prices at or above 500 €/MWh. This upward shift increases the equilibrium quan-

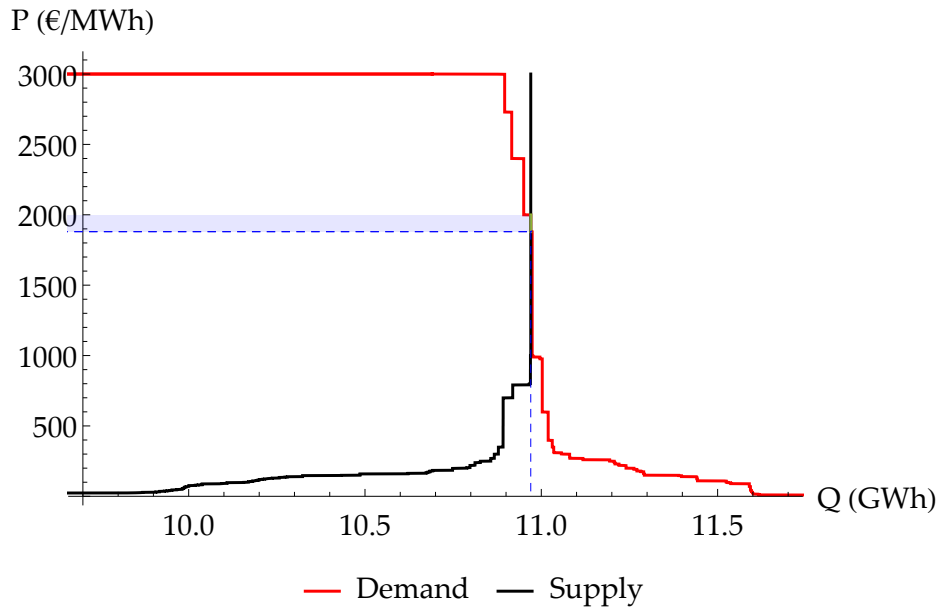

Figure 18: Market equilibrium in 13a.

tity to circa 11.00 GWh (11.0027 GWh to be exact) and decreases the price quite dramatically to 700 €/MWh.

- (c) Since the marginal cost of the already operative capacity is below the new market price ($200 < 700$), all of it remains in operation. There's no change in the costs of the existing capacity, but its revenue decreases with the market price. The loss of revenue is $\text{€}500(1880 - 700)$. Since the new market price is above the marginal cost of the additional capacity ($700 > 500$), all of it gets sold in the market, yielding a revenue of 100×700 euros. The cost of activation and production is $10000 + 400 \times 100$ euros. Summing these up gives the change in profit in euros:
- $$-500(1880 - 700) + 100 \times 700 - (10000 + 400 \times 100) = -570\,000.$$

Note that existing capacity brings more money than it costs. However, as the market price plummets, the loss of revenue from the existing capacity trumps this positive effect. Although 0.1 GWh is small compared to the total capacity on the market, even such a small shift can have a drastic effect on the equilibrium price when demand and supply are highly inelastic. Therefore, in this situation, if the supplier understands what is going on in the market it would not activate its last 100MW power station.

One lesson of this part was that a seller with a very small market share (here about 5-6%) can end up with significant market power at times when supply and demand curves are vertical (or close to vertical) near what would be the competitive market equilibrium. When a seller decides to withhold any capacity for the purpose of affecting the market price then the market is by definition not perfectly competitive.

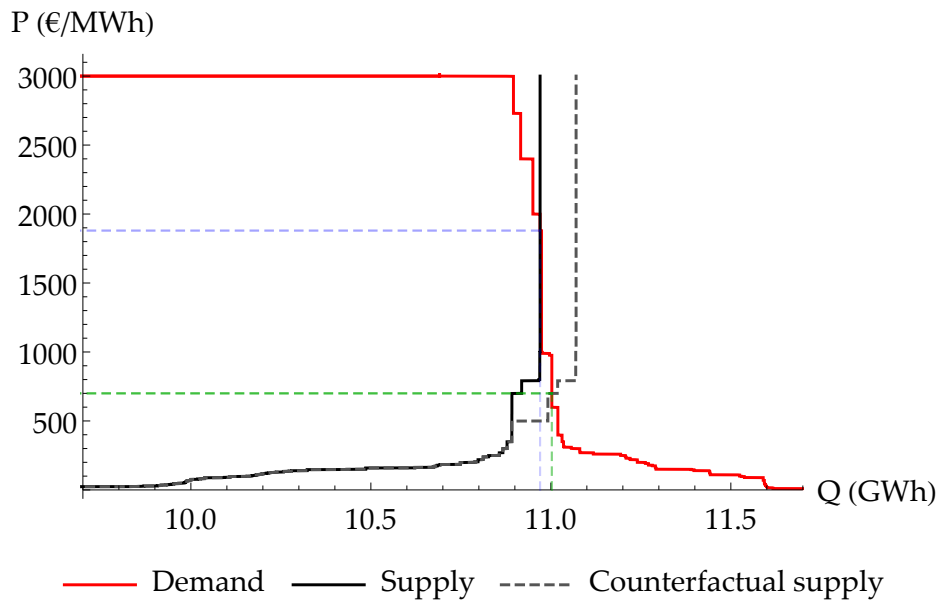

Figure 19: Market equilibrium in the counterfactual scenario of 13b.

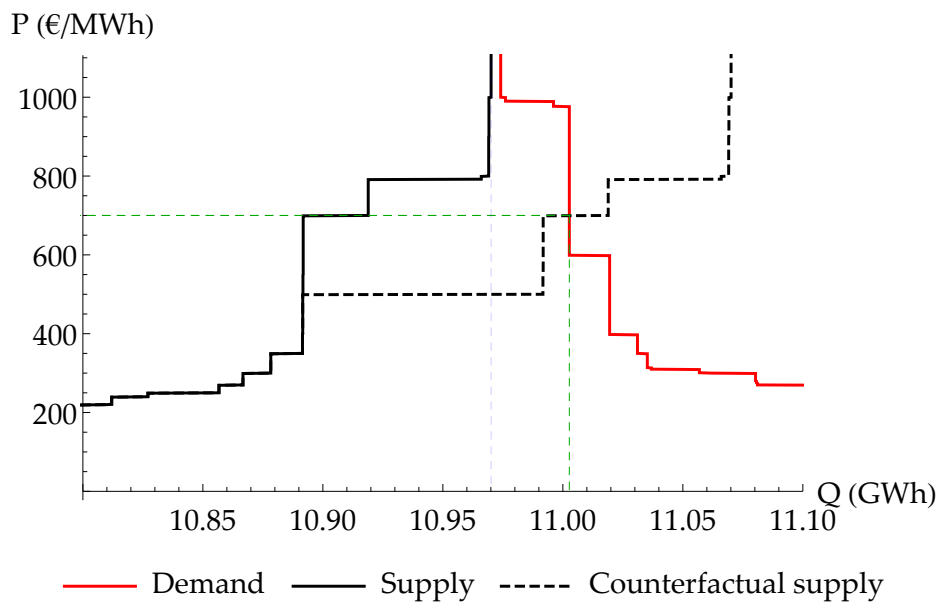

Figure 20: Close-up on Figure 19 near the equilibrium point.

2 Market power

14. (a) The firm simply equates marginal cost with marginal revenue:

$$\begin{aligned}\frac{\partial}{\partial q} q(1800 - 30q) &= 300 \\ q^* &= 25 \implies \\ p^* &= 1050 \implies \\ \pi^* &= 25(1050 - 300) - 6000 = 12750 > 0\end{aligned}$$

- (b) Now the typical quantity demanded ($q^d(p)$) is halved ($\tilde{q}^d(p)$) for every price.

$$\begin{aligned}p^d(q) &= 1800 - 30q \iff \\ q^d(p) &= 60 - p/30 \implies \\ \tilde{q}^d(p) &= 30 - p/60 \implies \\ \tilde{p}^d(q) &= 1800 - 60q\end{aligned}$$

$$\begin{aligned}\frac{\partial}{\partial q} q(1800 - 60q) &= 300 \\ q^* &= 12.5 \implies \\ p^* &= 1050 \implies \\ \pi^* &= 12.5(1050 - 300) - 6000 = 3375 > 0\end{aligned}$$

- (c) Now the optimal thing for the firm to do is to pick a point (price and quantity) on a typical year's demand curve, sell all the stuff on a typical year and waste half of the production in a snowless year.

The monopoly's expected revenue is $\mathbb{E}(R(q)) = 0.75(1800 - 30q)q + 0.25 \times 0.5(1800 - 30q)q = (7/8)(1800 - 30q)q$.¹ Optimum is found by equating marginal (expected) revenue with marginal costs:

$$\begin{aligned}(7/8)(1800 - 60q) &= 300 \\ q^* &\approx 24.3 \implies \\ p^* &= 1800 - 30q^* \approx 1071 > 400 \implies \\ \pi^* &= -300 * q^* - 6000 + (3/4)q^*p^* + (1/4)(q^*/2)p^* \approx 9482\end{aligned}$$

Why does the optimum lie on typical year's demand curve? Suppose the firm has settled with an optimal price p^* . Where lies the optimal quantity q^* ? Assume it's

¹Equivalently, this could be written as $\mathbb{E}(R(p)) = 0.75(60 - p/30)p + 0.25(30 - p/60)p$, and costs could be expressed as $300(60 - p/30)$.

below the demand curve of a snowless year, $q^* \leq 30 - p^*/60$. One could increase q^* a little, sell all the units in any year and derive a marginal revenue of p^* . On the other hand, if $q^* \geq 60 - p^*/30$, increasing q^* wouldn't affect sales at all since no additional consumers will buy at the price in any year. In between, $30 - p^*/60 < q^* < 60 - p^*/30$, producing an additional item increases revenue only in a typical year, yielding a marginal revenue of $0.75p^*$. Therefore, if $MC = 300 \leq 0.75p^* \iff p^* \geq 400$, it's profitable to increase production up to $q^* = 60 - p^*/30$.

- (d) Observe first that the restriction to price cuts is purely artificial. The firm could commit to an arbitrarily high price and cut it regardless of the snowfall. Since price is going to be higher in a typical year, the firm can announce the optimal price in a typical year and cut it in the case of a snowless year.

Through similar logic as in 14c, the optimal price-quantity pair is found on the demand curve of a typical year. Moving along the curve a bit doesn't affect the revenue in a snowless year at all as long as there is waste in a snowless year. Notice the difference with 14c where price had to be uniform across states.

Therefore expected marginal revenue is the probability of a year being typical times marginal revenue in such year, which must equal marginal cost:

$$\begin{aligned} 0.75(1800 - 60q) &= 300 \implies \\ q^* &\approx 23.33 \implies \\ p_t^* &= 1100 \end{aligned}$$

Revenue in a snowless year is maximized with $1800 - 120q = 0 \iff q = 15 \implies p_s^* = 900$. $23.33 - 15 = 8.33$ of the output is wasted. Expected profits are given by

$$\pi^* = 0.75 \times 23.33 \times 1100 + 0.25 \times 15 \times 900 - 23.33 \times 300 - 6000 \approx 9626$$

15. (a) First, observe that costs related to drug development and completion of the production facility are sunk: they have materialized in the past and will not influence the forward-looking production (pricing) decision of the monopolist. Second, since there is only one time period in this exercise there is no need for discounting. Hence, we apply the standard MR=MC-rule.

First, we derive aggregate demand. Because valuations are uniformly distributed, demand for a given market is multiplying individual unit demands: $Q^D(P) = N(1 - P/\bar{v})$, where N denotes market size (number of potential consumers) and \bar{v} denotes the highest reservation value among those consumers.

This means that demand for a yearly dose, in millions of doses, for rich (r) and poor (p) respectively, is

$$\begin{aligned}Q_r^D(p) &= 0.2(1 - p/1000) \\Q_p^D(p) &= 0.8(1 - p/200).\end{aligned}$$

By inverting these we find similarly have

$$\begin{aligned}P_r^D(q) &= 1000(1 - 5q) \\P_p^D(q) &= 200 - 250q.\end{aligned}$$

To get aggregate demand, we sum up demands for rich and poor. In doing so, note that there is a kink in aggregate demand at $p = 200$, above which only rich buy.

$$Q_A^D(p) = \begin{cases} 0.2(1 - p/1000), & 200 \leq p \leq 1000 \\ 1 - 0.0042p, & 0 \leq p < 200 \end{cases}.$$

In terms of quantity the kink point is at $Q_A^D(200) = 0.16$. See Figure 21 for an illustration. By inverting the demand piecewise we get aggregate demand in inverse form:

$$P_A^D(q) = \begin{cases} 1000(1 - 5q), & 0 < q \leq 0.16 \\ (5000/21)(1 - q), & 0.16 < q \leq 1 \end{cases}.$$

We can then apply the MR=MC-rule separately in the two cases and see which gives higher profits.

Marginal cost of one yearly dose is $52 \times 2 = 104$. For the case where only rich buy, marginal revenue is

$$\frac{\partial}{\partial q}(1000(1 - 5q)q) = 1000(1 - 10q)$$

and the solution to MC=MR results in $q^* = 0.0896$, $p^* = 552$.

For the case where both rich and poor buy, marginal revenue is

$$\frac{\partial}{\partial q}\left(\frac{5000}{21}(1 - q)q\right) = \frac{5000}{21}(1 - 2q)$$

and the solution to MC=MR results in $q^{**} = 0.2816$, $p^{**} = 171.0$.

By comparing profits at the two prices, we find that $(p^* - MC)q^* \approx 40.1 > (p^{**} - MC)q^{**} \approx 18.9$, where profits are in € million. We conclude that the profit-maximizing price for a yearly dose is 552.

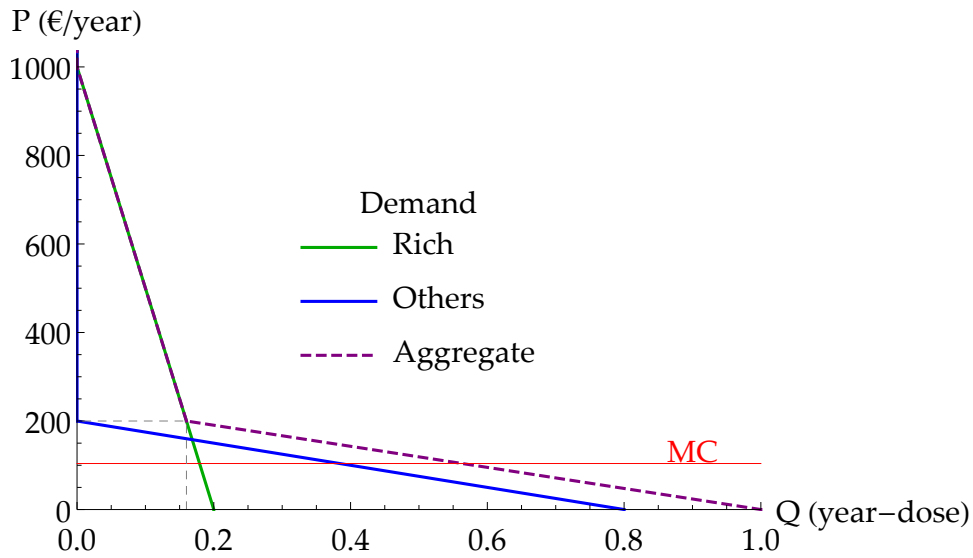

Figure 21: Demand in the pricing problem in 15a. “Others” refers to the poor.

- (b) We just found that, with uniform pricing, the profit-maximizing price is so high that only the rich will buy. This means that we have already found the price and quantity for rich under the regime where it is possible to customize the prices for rich and poor. It only remains to solve the profit-maximizing price for the poor now that they can be given access to a lower price while the rich still pay the higher price.

Marginal revenue for the poor is

$$\frac{\partial}{\partial q} ((200 - 250q)q) = 200 - 500q$$

and the solution to $MC=MR$ results in $q^{***} = 0.192$, $p^{***} = 152$.

Clearly the only changes in total profits and consumer surplus are the increases due to also the poor now purchasing the medicine. That is,

$$\begin{aligned} \Delta\pi_{tot} &= \pi_{poor} = (p^{***} - MC)q^{***} = (152 - 104)0.192 \approx 9.2, \\ \Delta CS_{tot} &= CS_{poor} = (P_p^D(0) - p^{***})q^{***}/2 = (200 - 152)0.192/2 \approx 4.6. \end{aligned}$$

where both profits and consumer surplus are in € millions.

16. (a) No customer has a valuation in excess of 30 euros and therefore quantity demanded goes to zero at $p = 30$, $Q^d(30) = 0$. On the other hand, if $p \leq 5$, all the 5000 customers will buy one unit of gadgets, $Q^d(5) = 5000$. Since valuations are uniformly distributed, demand is linear in the interval $[5, 30]$. Two points pin down a line and therefore $Q^d(p) = 6000 - 200p$ when $p \in [5, 30]$, 5000 when $p \leq 5$ and 0 otherwise. Its inverse is $p^d(Q) = 30 - Q/200$, defined when $q \leq 5000$. Intuitively, increasing the price by a euro drives away 200 customers.

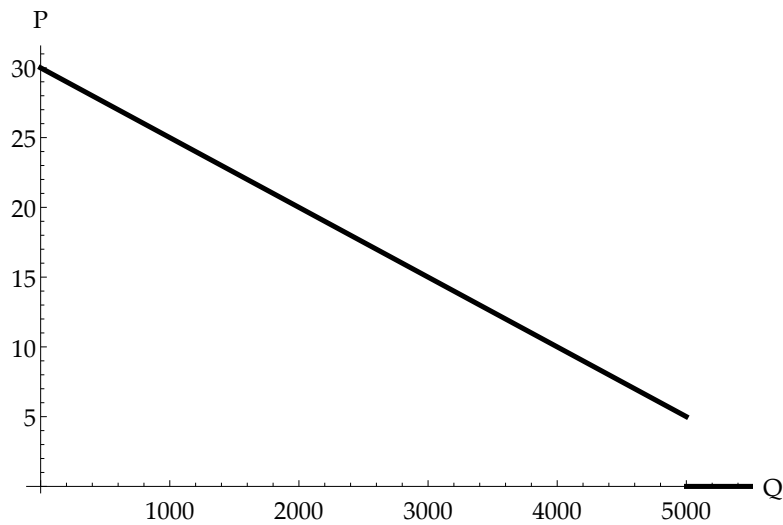

Figure 22: The demand curve facing Arskan Kone in 16a.

- (b) The rent is a fixed cost; its magnitude is independent of quantity produced. Since profit-maximizing requires a level of output where marginal cost equals marginal revenue, fixed cost has no weight in this equation and the resulting optimal price will be the same regardless of fixed cost. However, if fixed cost is too high the firm will find it unprofitable to produce at all.

Marginal costs are given by $MC(Q) = 2 + 14 = 16$ euros. Revenue is $R(Q) = Q \times p^d(Q) = 30Q - Q^2/200$ and marginal revenue by its derivative, $R'(Q) = MR(Q) = 30 - Q/100$. The profit maximizing price is found by equating these two:

$$\begin{aligned} 30 - Q/100 &= 16 \\ Q^* &= 1400 \implies \\ p^* &= 30 - 1400/200 = 23. \end{aligned}$$

Profits are then $\pi(Q^*) = (23 - 16)1400 - 10000 = -200$. By producing, the best the firm can achieve is negative profits. Consequently, the firm will set $Q^* = 0$. Customers will demand exactly zero at any price $p^* > 30$.

- (c) Consider that the firm would rise the price to 23.99 from the optimal price without the bias. In the previous subsection the quantity demanded would've dropped to 1202. Now the quantity only drops by 99 to 1301 as half of the customers don't make any difference between 23 and 23.99. (Their affliction is sometimes known as "left-digit bias.") However, increasing the price by one cent to 24 causes a discrete drop in quantity demanded down to 1200 with the bias.

It suffices to examine values nearby our initial equilibrium. Charging price 22.99 attracts 101 new customers and yields profits of $(22.99 - 14 - 2) \times 1501 - 10000 =$

492. Only 99 customers are lost if price is increased to 23.99, yielding profits of $(23.99 - 14 - 2) \times 1301 - 10000 \approx 395$. Therefore $p^* = 22.99$.

More generally, profit at price $p + 0.99$ is $(p + 0.99 - 14 - 2)(6000 - 200p - 99)$. From here one can obtain the same result as before easily. If even more rigorous, one could ask whether setting $p + d$, $d \in [0, 0.99]$, would be optimal instead. $(p + d - 14 - 2)(6000 - 200p - 100d)$ has either solution 22 or 23 depending on d so the optimum must lie in the interval $[22, 24]$. Then it's easy to show that 22.99 beats any other price in the interval.

17. (a) To find the market demand function, we should first note that identical distributions in valuations across consumers means that we can simply multiply the individual demand functions to obtain the market demand function:

$$Q^d(p) = N \times Q_i^d(p)$$

In this example, we can think of the individual consumers demand function as giving a probability of purchasing one unit for a given price level. That is,

$$Q_i^d(p) = \text{Prob}(v_i > p),$$

where $v_i \in [0, 20]$ denotes the valuation of consumer i . Clearly, this probability should be zero at $p = 20$, and one at $p = 0$. This means we can express the individual demand function as $Q_i(p) = 1 - p/20$. Knowing this, we can easily obtain the market demand function (which is an arbitrary good approximation of the realized demand, given that we have a large number of customers). That is,

$$Q^d(p) = 4000 \times (1 - p/20) = 4000 - 200p. \leftrightarrow \\ P^d(p) = 20 - q/200,$$

where the price function was obtained by inverting the demand function.

- (b) Here, the monopolist Acme Inc has to incur a fixed cost $FC = 2000$, which means it will only operate if it profitable to do so. Conditional on operating, it will set the quantity to equate marginal cost with marginal revenue, as usual.

To see if it will operate, we first proceed by calculating the optimal quantity, and then verify whether this is profitable. That is, $MR(q) = 20 - q/200 = 10 = MC(q) \leftrightarrow q^* = 1000 \rightarrow p^* = P^d(q^*) = 20 - 1000/200 = 15$.

This implies the following profits $\pi = 1000(15 - 10) - 2000 = 3000 > 0$. As it is indeed profitable to operate at these prices, we conclude by noting that the optimal price is $p^* = 15$.

- (c) We can proceed as in part as in the previous subsection by equating marginal revenue and marginal costs. For an unknown $N > 0$, market demand is given by $Q^d(p, N) = N(1 - p/20)$, and hence the price function is $P^d(q, N) = 20 - q(20/N)$. Equating marginal cost with marginal revenue: $MR(q, N) = 20 - q(40/N) = MC(q) = 10 \leftrightarrow q^* = N/4$. By substituting this into price function as usual, we get $p^* = P^d(N/4) = 20 - (N/4)(20/N) = 15$. One way to see why the optimal price is independent of N , is to note that the demand elasticity is independent of N , as this quantity merely indicates percentage changes in demand.

As in part b), we should still verify whether it is profitable to operate. Here, N plays a role in that it directly impacts the size of demand, and hence, revenues. We can solve for N to find the lower bound of customers that makes it profitable to operate: $\pi(N) = N(1 - 15/20)(15 - 10) - 2000 \geq 0 \leftrightarrow N \geq 1600$.

To conclude, provided $N \geq 1600$, Acme Inc operates and sets $p^* = 15$.

- (d) The monopolist either faces a demand function with $N = 4000$ with some probability λ , and no demand with some probability $1 - \lambda$. In maximizing its profits, the monopolist now has to take into account the uncertainty of demand, while cost is deterministic. We can express the expected profit for a given quantity as follows:

$$E(\pi(q)) = \lambda q(20 - q/200) - q10 - 2000$$

The monopolist maximizes expected profits, which means that the optimal quantity will be a function of probability λ . So we solve for optimal q :

$$\begin{aligned} \frac{\partial E(\pi(q))}{\partial q} &= 0 \\ \leftrightarrow q^*(\lambda) &= 2000(1 - 1/\lambda) \end{aligned}$$

We then solve for the λ at which it the monopolist is indifferent between producing or not. This is done by substituting the optimal quantity (expressed as a function of λ), and setting profits to equal zero:

$$\begin{aligned} \mathbb{E}(\pi(q^*(\lambda))) &= 0 \\ \rightarrow \lambda &\approx 0.78. \end{aligned}$$

That is, if $\lambda \geq 0.78$, the monopolist produces, and it produces $q^*(\lambda) = 2000(1 - 1/\lambda)$. Note: a tempting mistake to make here is to assume that the monopolist would produce a quantity such that $P^d(q) = 15$ when flu hits, as we found that the optimal price is independent of N , conditional on production. This is incorrect, as we are now considering uncertain demand, which is relevant for evaluating expected revenues.

18. (a) Note that the island nation is the sole producer of grumpkins. Therefore, it has market power and it has influence over the market price.

For optimal production decision, the island nation should produce so that at q^* , marginal revenue equals marginal cost, $MR = MC$. Firm's total cost function is:

$$TC(q) = VC(q) + FC$$

$$TC(q) = 300q + 15000$$

and revenue function is:

$$TR(q) = P^d \cdot q$$

$$TR(q) = (1800 - 60q)q$$

$$TR(q) = 1800q - 60q^2$$

and marginal revenue is:

$$MR(q) = 1800 - 120q$$

Optimal quantity, q^* , is at:

$$MR(q) = MC$$

$$1800 - 120q^* = 300$$

$$q^* = 12.5$$

and price is:

$$p^d(q^*) = 1800 - 60 \cdot 12.5$$

$$p^d(q^*) = 1050$$

Island nation's profit, π , is:

$$\pi = P \cdot q^* - 300q^* - 15000$$

$$\pi = 1050 \cdot 12.5 - 300 \cdot 12.5 - 15000 = -5625 < 0$$

Even after maximizing profit, it is not profitable to produce any grumpkins in most years for the island nation. Therefore, it is optimal not to produce. In this case, profit is zero and consumer surplus is zero. Pricing is irrelevant.

- (b) Marginal cost varies between years, it could be anywhere between 0 and 600 pounds. How do price, profits, consumer surplus vary with the marginal cost γ ?

We can check if the island nation turns profitable at the best scenario, where $\gamma = 0$. Island nation's profit function is decreasing in costs so zero marginal cost would be best for its profits.

Again, using the optimality condition, $MR = MC$, when $MC = 0$.

$$\begin{aligned} MR(q) &= 1800 - 120q \\ 1800 - 120q^* &= 0 \\ q^* &= 15 \end{aligned}$$

and price is:

$$\begin{aligned} p^d(q^*) &= 1800 - 60 \cdot 15 \\ p^d(q^*) &= 900 \end{aligned}$$

Island nation's profit, π , is:

$$\begin{aligned} \pi &= P \cdot q^* - 0 \cdot q^* - 15000 \\ \pi &= 900 \cdot 15 - 15000 = -1500 < 0 \end{aligned}$$

As profit is decreasing in costs and in γ and production is not profitable at $\gamma = 0$, we know that production is unprofitable for all $\gamma > 0$. In this case, profit is zero, consumer surplus is zero and pricing is irrelevant.

- (c) Fixed cost varies between years, it could be anywhere between 10 000 and 20 000 pounds. How do price, profits, consumer surplus vary with the fixed cost ϕ ?

Optimal production quantity is unrelated to the fixed cost. We know from 2 a.) that optimal production with the demand structure and marginal costs is, $q^* = 12.5$ at price $P = 1050$. We can check whether the production is profitable at $\phi = 10000$.

Island nation's profit, π , is:

$$\begin{aligned} \pi &= P \cdot q^* - 300 \cdot q^* - 10000 \\ \pi &= 1050 \cdot 12.5 - 300 \cdot 12.5 - 10000 = -625 < 0 \end{aligned}$$

Because $\pi < 0$ at $\phi = 10,000$ and profit is decreasing in fixed costs, production is also non-profitable for all $\phi > 10000$. Therefore, for $\phi \in [10000, 20000]$, production is not profitable and the island nation should produce zero. Again, profit is zero, consumer surplus is zero and pricing is irrelevant.

- (d) Demand for grumpkins varies between years, along with macroeconomic conditions in Hy-Brasil. This shows up in the choke price α , which varies between 1000 and 4000. That is, demand is $P^d(q) = \alpha - 60q$. How do the price and quantity of grumpkins vary with the demand shifter α ?

At $\alpha = 4000$:

$$\begin{aligned} TR(q) &= P^d \cdot q \\ TR(q) &= (4000 - 60q)q \\ TR(q) &= 4000q - 60q^2 \end{aligned}$$

and marginal revenue is:

$$MR(q) = 4000 - 120q$$

Setting quantity optimally:

$$\begin{aligned} MR(q) &= MC \\ 4000 - 120q^* &= 300 \\ q^* &\approx 30.83 \end{aligned}$$

Price at this point:

$$\begin{aligned} p^d(q^*) &= 4000 - 60 \cdot 30.83 \\ p^d(q^*) &= 1248.77 \end{aligned}$$

and profit is:

$$\begin{aligned} \pi &= P \cdot q^* - 300 \cdot q^* - 15000 \\ \pi &= 1248.77 \cdot 30.83 - 300 \cdot 30.83 - 15000 \approx 14251 > 0 \end{aligned}$$

Now, with higher demand, the island nation's production turns profitable.

Next, quantify how the optimal quantity and price depend on the demand shifter α . Optimal quantity decision depends on marginal revenue function and marginal costs. Marginal cost is constant but marginal revenue depends on demand, which is a function of α . First, write total revenue as a function of α :

$$\begin{aligned} TR(q) &= P^d \cdot q \\ TR(q) &= (\alpha - 60q) \cdot q \\ TR(q) &= \alpha q - 60q^2 \end{aligned}$$

marginal revenue is:

$$MR(q) = \alpha - 120q$$

Optimal quantity is:

$$\begin{aligned} MR(q) &= MC \\ \alpha - 120q^* &= 300 \\ q^* &= \frac{\alpha}{120} - 2.5 \end{aligned}$$

and price:

$$\begin{aligned} p^d(q^*) &= \alpha - 60 \cdot \left(\frac{\alpha}{120} - 2.5 \right) \\ p^d(q^*) &= 0.5\alpha + 150 \end{aligned}$$

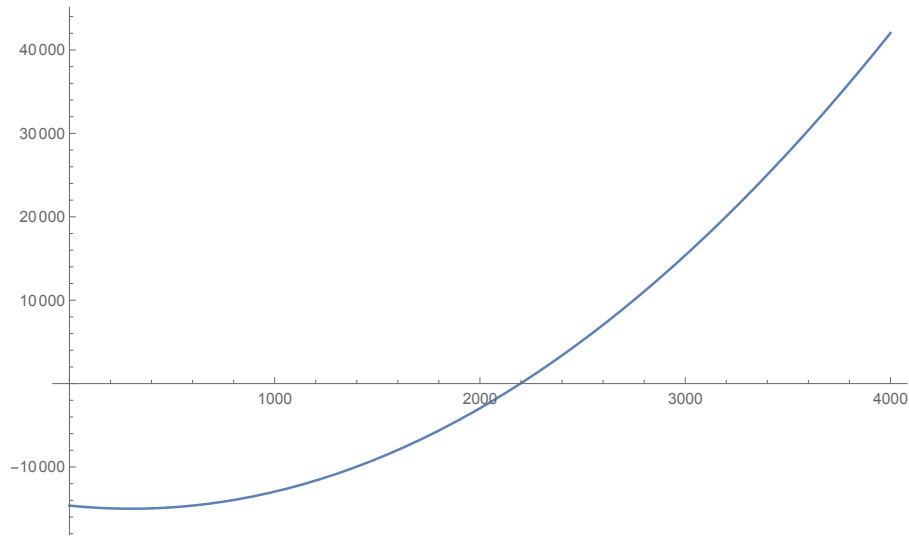

Figure 23: Profit as a function of demand shifter in 18d.

We have that optimal production quantity depends on the demand shifter, α , in the following way: $q^*(\alpha) = \frac{\alpha}{120} - 2.5$ and price: $p^d(\alpha) = 0.5\alpha + 150$.

Next, we need to check the demand where profit turns non-negative. To do this, we can write profit as a function of $q^*(\alpha)$ and $p^d(\alpha)$:

$$\begin{aligned}\pi &= P \cdot q^* - 300 \cdot q^* - 15000 \\ \pi &= (0.5\alpha + 150)\left(\frac{\alpha}{120} - 120\right) - 300 \cdot \left(\frac{\alpha}{120} - 2.5\right) - 15000\end{aligned}$$

In order to check where the profit function turns positive, we can set $\pi = 0$ and solve the equation with respect to α :

$$(0.5\alpha + 150)\left(\frac{\alpha}{120} - 120\right) - 300 \cdot \left(\frac{\alpha}{120} - 2.5\right) - 15000 = 0$$

This function has one positive root where $\alpha \approx 2197.37$. Therefore, when $\alpha \geq 2197.37$, production is profitable and production follows the equation $q^*(\alpha) = \frac{\alpha}{120} - 2.5$ and pricing follows: $p^d(q^*) = 0.5\alpha + 150$.

19. (a) Here, the monopolist sets quantity to equate marginal marginal revenue. That is, $MR(q) = 200 - 2q = MC(q) = 20 \leftrightarrow q^* = 90 \rightarrow p^* = P^d(q^*) = 200 - 90 = 110$.

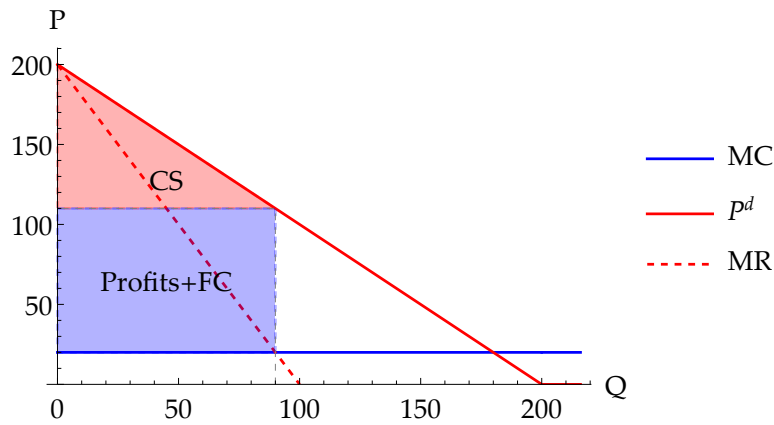

Figure 24: Monopoly pricing with fixed costs.

The monopoly operates only if it is profitable to do so; $\pi = 90(110 - 20) - 7200 = 900 \geq 0$.

Knowing that the monopolist will indeed produce, the consumer surplus is given by $CS = 1/2[(200 - 110)90] = 4050$.

- (b) As total consumer surplus is by definition the area between the demand curve and the horizontal line corresponding to the price level, it is clear that this quantity is increasing when the price decreases, provided that the monopolist produces. This is because a lower price will both increase the surplus for any consumer initially buying the product, and it will induce additional consumers to buy the product.

From the above, it directly follows that the price cap \bar{p} , should be so low as to barely make it profitable for the monopoly to produce: $\pi = Q^d(\bar{p})(\bar{p} - 20) - 7200 = 0 \rightarrow \bar{p} = 80$ or $\bar{p} = 140$. There are two solutions to this polynomial, so the lower value is the desired price cap, that is, $\bar{p} = 80$. Note that at this price level, the price exactly equals average costs, as indicated in figure 25.

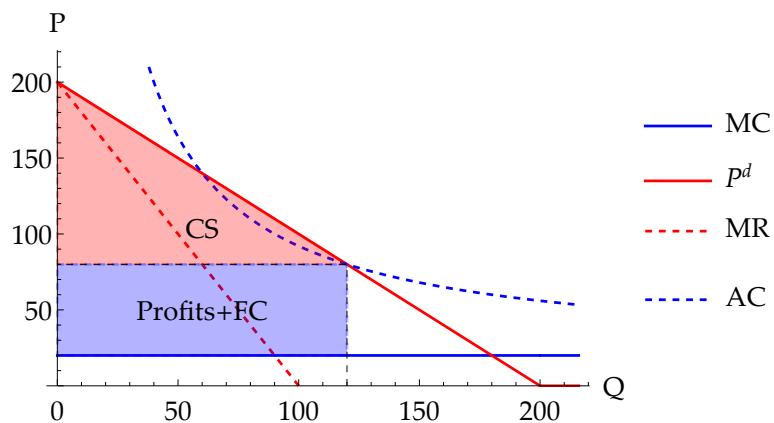

Figure 25: Consumer surplus maximizing price cap.

- (c) The error in the estimation of the fixed cost of the monopolist implies that the true value takes values as follows: $FC \in [0, 14400]$. Noting that the monopolist only produces if $FC = 7200 + x \leq 7200$, it follows that the monopolist will not produce if $x > 0$. Provided that the monopolist produces, fixed costs do not matter in its price-quantity decision, as this is dictated only by the decision to equate marginal revenue with marginal costs. This means that if $x < 0$, the monopolist produces $Q^d(\bar{p}) = 200 - 80 = 120$. From this, we can calculate the Consumer surplus: $CS = 1/2[(200 - 80)120] = 7200$.

For profits, the impact is straightforward. If $x < 0$, so that the monopoly produces, any decrease in x will be directly passed into profit of the monopolist, as price and quantity are independent of the fixed cost, provided production takes place. If $x \geq 0$, nothing changes as the cap was initially set to induce the monopolist to make zero profits, and not producing also implies zero profits.

We can summarize the above observations formally as follows:

$$\Delta\pi(x) = \begin{cases} -x, & x < 0 \\ 0, & x \geq 0 \end{cases}$$

$$\Delta CS(x) = \begin{cases} -7200, & x > 0 \\ 0, & x \leq 0 \end{cases}$$

20. (a) The consumer price for electricity can be factored in two parts: $p = 2 + p_t$, where p_t is the transmission fee and 2 is the cost of electricity itself. The capacity needed to host the demand, as a function of the grid company's price is

$$k(p_t) = 100 - 10(2 + p_t) = 80 - 10p_t \iff \\ p_t^d(k) = 8 - k/10$$

The company's revenue is $R(k) = k(8 - k/10)$ and marginal revenue by $R'(k) = 8 - k/5$. Equating this with the marginal cost of providing the capacity, $c'(k) = 1$, yields the optimal capacity and price:

$$8 - k/5 = 1 \implies \\ k^* = 35 \implies \\ p_t^* = 4.5, \implies \\ \pi^* = 35 * (4.5 - 1) - 30 = 92.5 \\ p^* = 2 + p_t = 6.5$$

We need to calculate inverse demand for consumer surplus. $Q^d(p) = 100 - 10p \iff p^d(Q) = 10 - Q/10$. Consumer surplus is the given by $CS = (10 - 6.5) \times 35/2 = 61.25$ and total surplus $S = \pi^* + CS = 153.75$.

(b) We start by expressing the surplus as a function of k :

$$S(k) = \underbrace{k(8 - k/10)}_{\text{revenue}} - \underbrace{30 - k}_{\text{costs}} + \underbrace{(10 - (2 + (8 - k/10)))k/2}_{\text{consumer price}} = -30 + 7k - k^2/20$$

profit consumer surplus

First order condition is

$$7 - k/10 = 0 \iff k^* = 70.$$

Unfortunately, the grid company's profit is negative at the optimum, $70(8 - 70/10) - 30 - 70 = -30$. Since $S(k)$ is a downward-opening parabola ($S''(k) < 0$), surplus is increasing up to $k = 70$. Therefore the (constrained) optimum lies in the point where profits are equal to zero:

$$k(8 - k/10) - 30 - k = 0 \\ k^* = 5(7 + \sqrt{37}) \approx 65.4$$

Note that the above equation has another root at $k \approx 4.6$. We picked the greater of the roots as the total surplus is increasing in k for $k < 70$.

The company sets price $p_t = 8 - k^*/10 \approx 1.46$. Consumer price is then $p = p_t + 2 = 3.46$. Since profits are equal to zero, total surplus equal consumer surplus, $S(k^*) = CS = -30 + 765.4 - 65.4^2/20 \approx 214$.

(c) For a profit maximizing monopolist, fixed costs are relevant for the decision whether to produce anything at all while they don't affect the optimal price or quantity once that decision is made. Since profits are well above zero in 20a, a small increase in fixed costs doesn't change the answer.

21. All quantities are in thousands of liters a month, prices in marks per thousand liters.

Start by aggregating the demand by adding each individual household's demand on top of each other: $Q^D(p) = \sum_{i=1}^{1000} Q_i^D(p) = \sum_{i=1}^{1000} 10 - p = 1000(10 - p) = 10000 - 1000p$.

In the inverse form the demand is $P^D(q) = 10 - q/1000$.

(a) Our familiar condition of matching marginal revenue and cost applies: $MC(q) = MR(q)$ in the monopolist's optimum. $MC(q) = 1$ and $MR(q) = \frac{\partial q(10 - q/1000)}{\partial q} = 10 - q/500$. Setting these equal yields $10 - q/500 = 1 \implies q^* = 4500$. There are 1000 households and therefore consumption per household is 4.5.

Plugging optimal quantity into inverse demand we get $p^* = p^D(q^*) = 10 - 4500/1000 = 5.5$. Waterwork will make monthly positive profits as $\pi(q^*) = (5.5 - 1) \times 4500 - 3000 = 17250$. Otherwise it would optimally have run the plant down.

Demand curve meets marginal costs at $1 = 10 - q/1000 \implies q^* = 9000$. Therefore deadweight loss is $(9000 - 4500)(5.5 - 1)/2 = 10125$ marks a month.

Consumer surplus is $(10 - 5.5)(4500 - 0)/2 = 10125$ and this divided between 1000 households gives surplus 10.125 euros per month each.

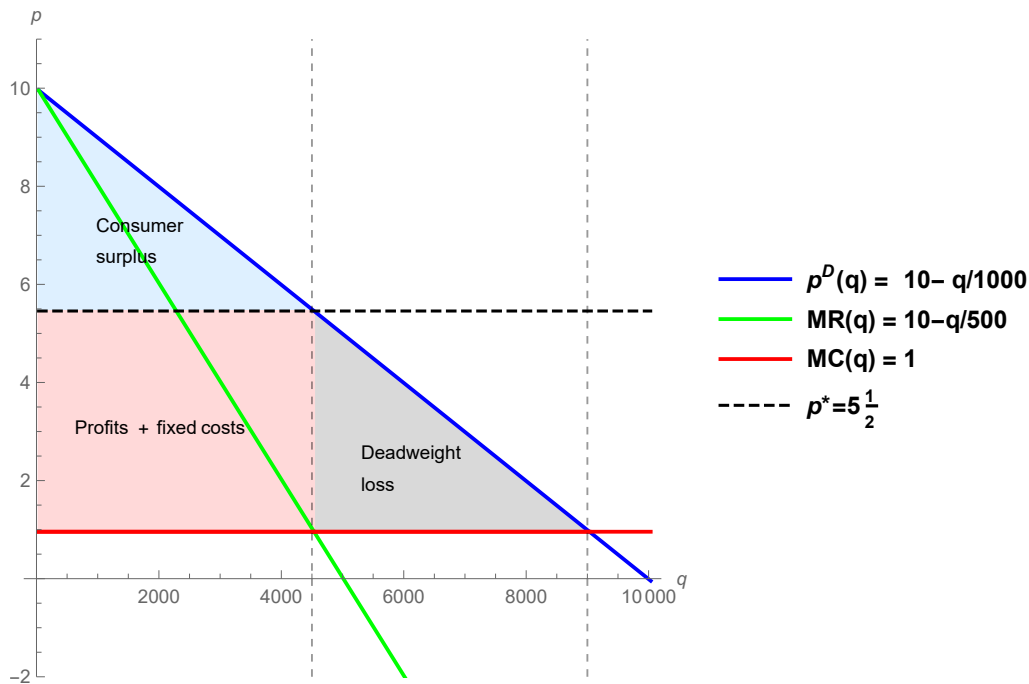

Figure 26: Monopolist waterworks in 21a.

- (b) Setting $p = 0$ generates the greatest consumer surplus, $(10000 - 0)(10 - 0)/2 = 50000$, which makes 50 per household a month. Profits would be $\pi(q^0) = (0 - 1) \times 10000 - 3000 = -13000$.

Producing the last 1000 units is wasteful as the cost exceeds consumers' willingness to pay. Deadweight loss (that little triangle in the lower right corner of Figure 26) is thus $(10000 - 9000)(1 - 0)/2 = 500$.

- (c) Consumer surplus is decreasing in price. Therefore we must find the greatest quantity, or equivalently lowest price, at which the waterwork can earn at least zero profits. Profits are zero when price equals average cost. Average cost is $AC(q) = TC(q)/q = 3000/q + 1$. Let's find the level of production at which consumers are willing to pay the average cost price.

$$\begin{aligned}
 P^d(q) = AC(q) &\iff 10 - q/1000 = 3000/q + 1 \\
 &\implies 10q - q^2 - 3000 - q = 0
 \end{aligned}$$

This is a second degree polynomial. Since consumer welfare is increasing and average cost is decreasing in quantity q , the larger root is the sensible one here. Thus $q^{**} = 500(9 + \sqrt{69}) \approx 8653$ and $p^{**} = P^d(q^{**}) = 10 - q^{**}/1000 \approx 1.35$.

Total consumer surplus and deadweight loss can be calculated as simple areas, similarly as in Figure 26. Deadweight loss is $(9000 - 500(9 + \sqrt{69}))(.5(11 - \sqrt{69}) - 1)/2 \approx 60.1$. Total consumer surplus stands as $(500(9 + \sqrt{69}) - 0)(10 - .5(11 - \sqrt{69}))/2 \approx 37440$ a month, which makes 37.44 for each household. After taking into account fixed costs, profits are zero (by construction).

- (d) Through similar aggregation as before, the new demand curve is $Q_2^D(p) = \sum_{i=1}^{500} Q_i^D(p) = \sum_{i=1}^{500} (10 - p) = 500(10 - p) = 5000 - 500p$. Its inverse stands as $P_2^D(q) = 10 - q/500$. Following the same steps as in 21a, we have $MC(q) = MR(q) \iff 1 = \frac{\partial}{\partial q} q(10 - q/500) = 10 - q/250 \implies q_2^* = 2250$. Consumption per household remains the same, 4.5. Plugging into inverse demand curve we get $p_2^* = P_2^D(q_2^*) = 10 - 2250/500 = 5.5$. Because households are identical and buy same amount of water at the same price, consumer surplus must be unchanged as well.

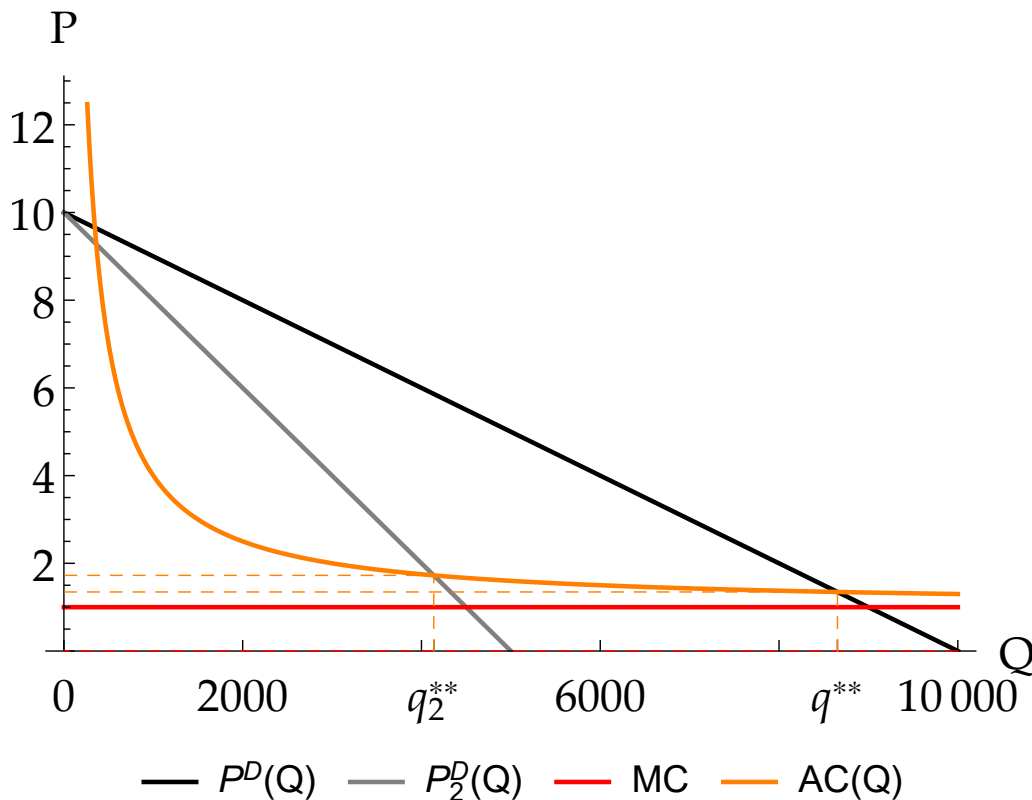

Figure 27: Average cost pricing before and after the population decline in 21d. The waterworks breaks even at both roots of $AC(q) = P^d(q)$ but the smaller root corresponds to welfare-minimization subject to average cost pricing; moving to the right along the q -axes until q^{**} adds output that consumers value above both marginal and average costs.

The waterwork would make *profits* $(5.5 - 1) \times 2250 - 3000 = 7125$. Marginal costs meet demand at $1 = 10 - q/500$ from which we can solve the efficient level $q = 4500$. Therefore *deadweight loss* is $(4500 - 2250)(5.5 - 1)/2 = 5062.5$ marks per month, through similar geometry as before.

As for part 21c, average cost pricing condition is now $10 - q/500 = 3000/q + 1$, for which the reasonable root is now $q_2^{**} \approx 4137$, resulting in a price of $p_2^{**} \approx 1.73$, and consumption per household of about 8.3 thousand liters per month. Using similar geometry as before, consumer surplus per household is $17119/500 \approx 34$ marks per month, and profits are zero by construction.

After the population decline, the fixed cost of the waterworks infrastructure has to be spread over a smaller number of consumers. The price must increase and average consumer welfare must decrease. Notice that the direction of the change in total surplus (consumer surplus plus profit) does not depend on the pricing regime.

3 Public goods, welfare analysis

22. (a) To find the efficient amount of cleaning hours q , we start by constructing the aggregate demand for cleaning by summing up the valuations for each individual in the household:

$$P^d(q) = \sum_i P_i^d(q), \quad i \in \{K, J, H\}$$

In doing this, we need to pay attention to kinks that may appear in the aggregate demand function, in particular, Hanna and Jaska do not value more cleaning at all at $q \geq 24$. Noting this, the aggregate demand function becomes:

$$P^d(q) = \begin{cases} 64 - q8/3, & 20 \geq q > 0 \\ 24 - q2/3, & 24 \geq q > 20 \end{cases}$$

This quantity also indicates the marginal benefit to the household of incrementally increasing the number of cleaning hours. Hence, the efficient number of hours is such that it equates the total marginal benefit with total marginal costs, that is, $P^d(q) = MC(q)$. We could proceed by trial and error, but by inspecting figure 28 we see that the marginal cost line intersects the marginal benefit curve at the upper part, where each individual values additional cleaning. Hence, we can solve for the efficient number of hours as follows: $P^d(q) = 64 - q8/3 = MC(q) = 16 \rightarrow q^* = 18$.

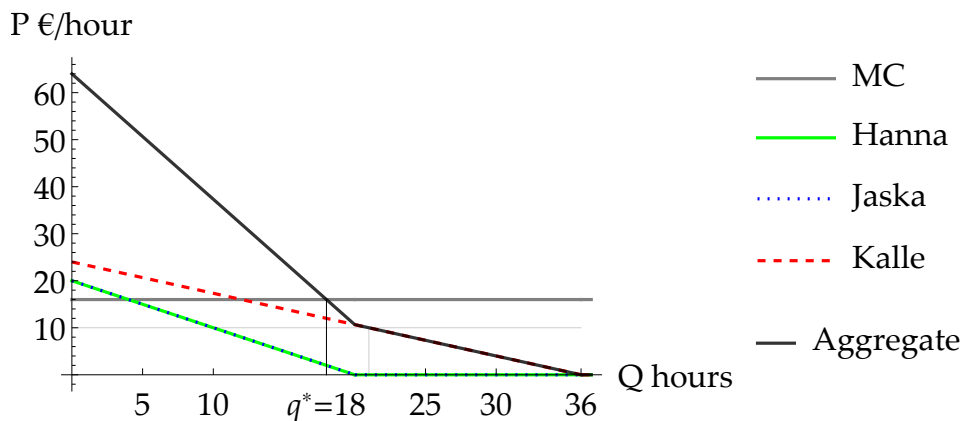

Figure 28: Household aggregate demand for cleaning.

Consumer surplus for each individual in the household is the area below the demand curve, subtracted by the cost paid by the consumer, a rectangular area. That is,

$$CS_i(q^*) = \int_0^{q^*} P_i^d(q) dq - TC_i(q^*)$$

Rather than evaluating the integral, we can also proceed by simply calculating the area below the demand curve for each individual, and then subtract the total cost from this:

$$\begin{aligned} CS_{J,H}(18) &= 1/2(20 \times 20 - (20 - 2)^2) - 18 \times 16/3 \\ &= 102, \\ CS_K(18) &= 1/2[24 \times 36 - (24 - (2/3)18)(24 - 18)] - 18 \times 16/3 \\ &= 228. \end{aligned}$$

- (b) Given that Hanna and Jaska have identical preferences, their vote will obviously win, and hence the amount of cleaning will be decided by them. How will they vote? In voting, they will consider the amount of cleaning that maximizes their own consumer surplus, that is,

$$q^M = \arg \max_q CS_{J,H}$$

We can find q^M by taking the derivative of the consumer surplus function of Hanna and Jaska, and solve for the maxima:

$$\begin{aligned} \frac{\partial CS_{J,K}(q)}{\partial q} &= 0 \\ \Leftrightarrow 1/3(44 - 3q) &= 0 \\ \Leftrightarrow q^M &= 44/3 \approx 14.67. \end{aligned}$$

To find the resulting surpluses, we again evaluate the consumer surpluses at the relevant amount of cleaning:

$$\begin{aligned} CS_K(q^M) &= 1/2[(36 \times 24) - (36 - 44/3)(24 - (2/3)(44/3))] - (44/3)(16/3) \\ &\approx 202.07, \\ CS_{H,J}(q^M) &= 1/2(20^2 - (20 - 44/3)^2) - (44/3)(16/3) \\ &\approx 107.56 \end{aligned}$$

- (c) The availability of a professional cleaner that is twice as effective as the individuals in the household means that the household can effectively purchase one hour of their own cleaning output for $10e$ (that is, half an hour of cleaning service from the professional). What matters here is how they value the cost of cleaning in terms of money. Since this option is cheaper, this is the new marginal cost of cleaning.

In finding the efficient amount of cleaning, the household should again equate the total marginal benefit with the marginal cost. In looking for the point of intersection

between the aggregate demand curve and the cost curve, we can for instance proceed by trial and error. At the upper part of the curve, we have $64 - q8/3 = 10 \leftrightarrow q = 81/4 \approx 20.25 > 20$. We see that this quantity is not feasible, given the shape of the demand curve and the the implied bounds. For the lower part, we have $24 - q2/3 = 10 \leftrightarrow q^* = 21$. This quantity is feasible and implies that only Kalle gets additional utility from the last hour of cleaning.

23. (a) The cost of an additional time unit of research should equal the marginal benefit from that unit. To obtain marginal benefit, we must aggregate the countries' individual marginal benefits into one. Notice that once a demand curve or a marginal benefit curve reaches it stays there. These choke points are $\tilde{Q}_W = 8$ and $\tilde{Q}_E = 6$

$$P^D(Q) = \begin{cases} 96 - 12Q + 60 - 10Q = 156 - 22Q, & 0 \leq Q \leq 6 \\ 96 - 12Q, & 6 < Q \leq 8, \\ 0, & Q > 8 \end{cases}$$

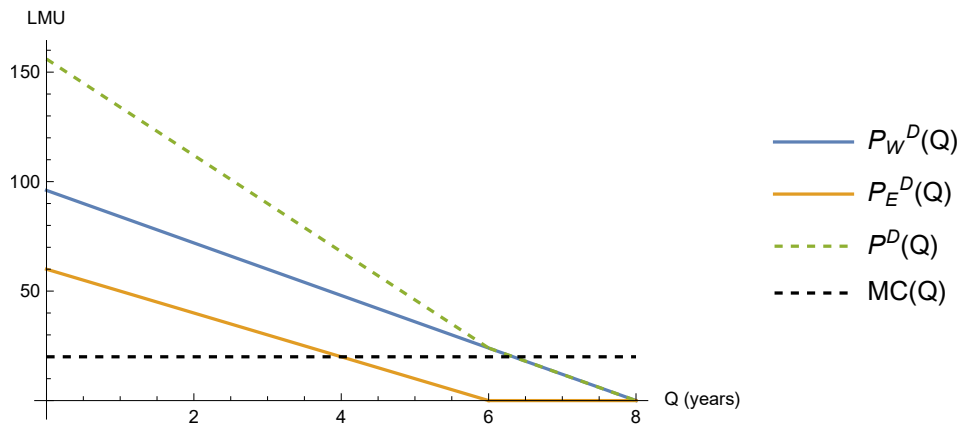

Figure 29: Aggregation of demand for research on the cure for lycanthropy in 23a.

Let's first search for the optimum from the interval $6 < Q \leq 8$: $96 - 12Q = 20 \iff Q^* = 19/3 \approx 6.33$. Since marginal benefit $P^D(Q)$ is decreasing and marginal cost constant, this must be the only solution. Total benefit is then $TB(Q^*) = 60 \times 6/2 + (96 - (96 - 12Q^*)) \times Q^*/2 \approx 421$.

Total cost is $TC(Q^*) = 20 \times Q^* \approx 127$ and therefore benefits clearly exceed the costs (which might seem clear since there are no fixed costs from the provision of the good).

- (b) Let's first consider Eastland's optimal choice as if it was alone $60 - 10Q = 20 \iff Q_E^* = 4$. If Westland commits to $19/6 \approx 3.17$, Eastland will provide the rest, $4 - 3.17 \approx 0.83$. Any additional units would cost Eastland more than give benefit.

Westland will provide the remaining half in full (3.17) if Eastland commits to another half by the same argument as above. Calculations were already made in 23a.

- (c) The optimum doesn't change from 23a. The introduction of Northland changes the marginal benefit curve below the optimum only. The effective marginal benefit curve will be just the same in the interval $6 < Q \leq 8$ where the optimum is again found at $Q^* \approx 6.33$.

24. Common defense in Northland is a public good. You cannot exclude any clans from it. At least during peacetime, defense is more of a threat that won't exhaust, making it a public good. A threat on eastern border probably won't scare an enemy coming from the west and so it's probably not purely a public good. Let's, however, assume that fighter planes are mobile enough for us to ignore such considerations.

All monetary quantities are in millions of euros, defense quantities in number of fighter planes

- (a) Northland should purchase a number of fighter planes such that the marginal benefit from the last plane purchased equals the associated cost.

As a reminder, inverse demand depicts the consumers' (clans' in this case) willingness to pay for the q :th unit of the good. Inverse demands for the clans are given by

$$Q_A(p) = 60 - 6p \iff p_A(q) = 10 - q/6$$

$$Q_B(p) = 80 - 5p \iff p_B(q) = 16 - q/5$$

$$Q_C(p) = 50 - 2p \iff p_C(q) = 25 - q/2$$

Marginal cost is constant, $MC(q) = MC = 25$. Summing up the above equations we get the marginal benefit and efficient quantity thus is such that $25 = 10 - q/6 + (16 - q/5) + (25 - q/2) \implies q^* = 30$. We also must ensure that no clan's willingness to pay isn't negative at the efficient level: $p_A(q^*) = 5 > 0$, $p_B(q^*) = 10 > 0$, $p_C(q^*) = 10 > 0$.

- (b) The constitution obliges the clans to share the cost evenly and therefore the burden is $MC \times q^*/3 = 25 \times 30/3 = 250$ for each of the clans. Applying some geometry to Figure 30, we get

$$TS_A = (5 - 0)(30 - 0) + (10 - 5)(30 - 0)/2 - 250 = -25$$

$$TS_B = (10 - 0)(30 - 0) + (16 - 10)(30 - 0)/2 - 250 = 140$$

$$TS_C = (10 - 0)(30 - 0) + (25 - 10)(30 - 0)/2 - 250 = 275$$

- (c) Each clan faces a marginal cost $MC = 25/3$ which would optimally match marginal benefit for that clan. Should they be able to have their will, we'd have the following spendings:

$$p_A(q) = 10 - q/6 = 25/3 \implies q_A^* = 10$$

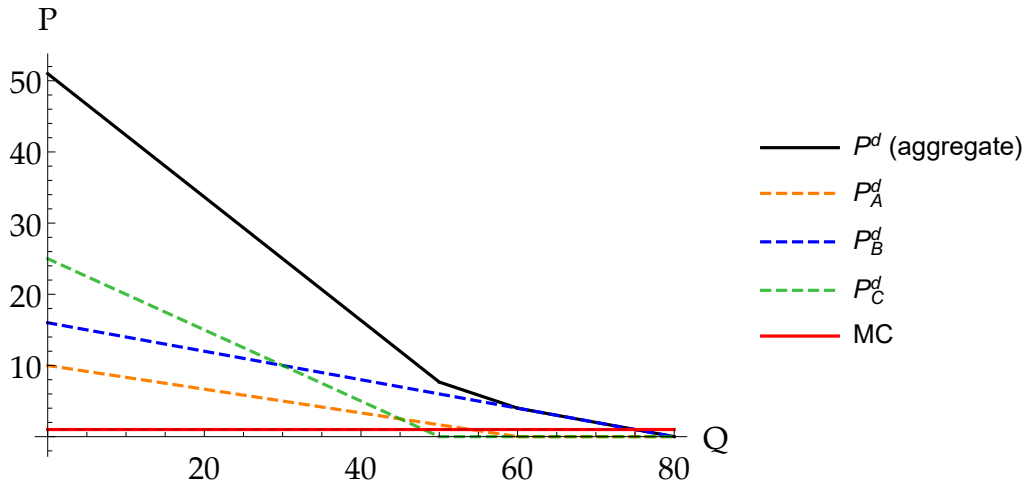

Figure 30: Demand for defense by each clan separately and in the aggregate in Problem 24.

$$p_B(q) = 16 - q/5 = 25/3 \implies q_B = 38\frac{1}{3}$$

$$p_C(q) = 25 - q/2 = 25/3 \implies q_C = 33\frac{1}{3}$$

Each of the inverse demand curves is of form $p_i(q) = a_i - b_i q$. Therefore the total surplus before costs is a nice trapezoid (with left side of a_i and right side of $a_i - b_i q$) whereas costs are even nicer rectangle, yielding

$$TS_i(q) = q(a_i + a_i - b_i q)/2 - 25q/3 = q(a_i - 25/3) - b_i q^2/2.$$

These are downward opening parabolas which are symmetric. Therefore, the further we're from the optimal q , the greater is the offset from maximal total surplus and also $q_B^* = 38$ and $q_C^* = 33$, as planes don't come in fractions. By the same argument we know that for A, $q_A^* \succ q_C^* \succ q_B^*$, for B $q_B^* \succ q_C^* \succ q_A^*$ and for C $q_C^* \succ q_B^* \succ q_A^*$.

C is the median voter. Because surpluses are single-peaked, we know that Arrow's impossibility theorem won't apply and *median voter will prevail*.

To grasp the intuition, in pairwise votes A's proposal never gets majority of the votes as it's the worst option for other chiefs. If A is voted on the first round, it's eliminated and second round will be B vs C which C will take. If A is not removed, first round must have been B vs C. C will prevail and beat A on the second round.

Why single-peakedness is important is best explained by counterexample: assume B's preferences would be B $q_B^* \succ q_A^* \succ q_C^*$ and others' unchanged. Then A vs B would have A as the winner, A vs C C as the winner and B vs C B as the winner. For example, voting first B vs C and then B vs A would have A chosen, voting first A vs B and then A vs C would have C as the result.

25. (a) There are 5 firms with valuation of 8 m€ and 5 firms with valuation of 3m€. The city has basically two options for the price as far as maximizing revenue is concerned: either it sets $p = 3$, everybody will join and the city will gather a revenue of 30m€.

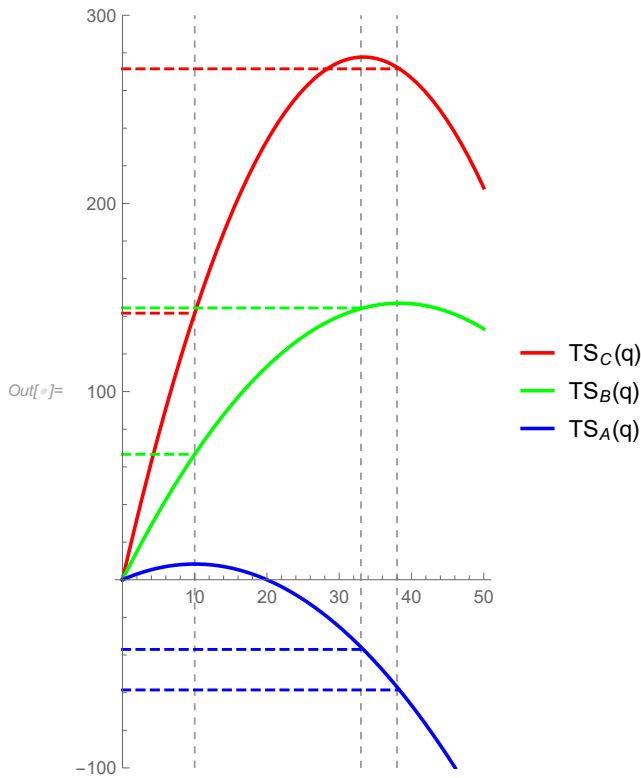

Figure 31: Surpluses of the clans as functions of quantity in Problem 24.

Charging anything less would not increase the number of participants and revenue would sink. With $p = 8$ revenue will be 40 m€. Since the construction would cost 50m€ the tunnel will not be built. Total surplus is zero.

- (b) The revenue is maximized at 40 m€ with $p = 8$. Additionally, the city imposes a tax of $(50 - 40)/10 = 1$ m€ on all the properties. Tunnel is therefore built, half of the properties get a surplus of $8 - 8 - 1 = -1$ and the other half -1 as well, as they are not willing to pay for the connection ($8 > 3$) but are charged the tax. Total surplus is total benefit from those who get to use the tunnel minus cost of construction, $5 \times 8 - 50 = -10$ m€.
- (c) The total benefit from the tunnel would be $5 \times 8 + 5 \times 3 = 55 > 50$. Therefore building the tunnel is efficient if also low valuation properties use the tunnel. Therefore a connection must have $p \leq 3$. Of these prices, $p = 3$ maximizes revenue and therefore minimizes the need for taxation. A tax of $(50 - 3 \times 10)/10 = 2$ m€ is levied on all the properties. Low valuation properties get a surplus of $3 - 3 - 2 = -2$, high valuation properties get $8 - 3 - 2 = 3$. Total surplus is $55 - 50 = 5$ m€.

- 26. (a) This museum is a club good because it is never congested but entrance can be metered and charged for. The efficient number of of daily visitors is such that each visitor with valuation above the marginal cost visits the museum.

Valuations are drawn from a uniform distribution between 0 and 10€, so 80% of potential visitors have valuations above marginal costs of 2€ in any given day.

This means that the daily number of visitors will be 800 in July, and 400 in September. This also immediately implies that the efficient price of a visit is 2€ in each month.

- (b) Maximization of total yearly welfare under the constraint of budget balance is achieved by average cost pricing. The price of museum visits will now be above marginal cost, but not any higher than it need be.

To do so, we first construct demanded quantities in July (J) and September (S) (i.e., summer and non-summer months).

$$Q_J^D(p) = 1000(1 - p/10),$$

$$Q_S^D(p) = 500(1 - p/10).$$

This means aggregate demand for the whole year is

$$Q^D(p) = 30(3 \times Q_J^D(p) + 9 \times Q_S^D(p)).$$

Next, we find the price consistent with average cost pricing:

$$AC(p) = \frac{FC}{Q_Y^D(p)} + MC = p$$

$$\Rightarrow FC = (p - MC)Q^D(p)$$

$$\Rightarrow 270000 = (p - 2)30[3 \times 1000(1 - p/10) + 9 \times (500(1 - p/10))].$$

The sensible solution to the quadratic equation is $p_{AC} = 4$. (The other solution is higher, thus leading to lower consumer surplus while also balancing the budget. As such, the higher price is wrong in that it does not maximize total welfare.)

Additional comment. Breaking even month by month (assuming fixed costs distributed evenly over the year) would result in a lower price in summer months than in other months. This would result in lower consumer surplus than charging the same price every month. To see why this must be so, notice that then the highest-value customer who does not visit the museum in a summer month would value a visit by more than the lowest-value customer who does visit on a non-summer month. Just by changing the pricing it is possible to swap their visiting decisions pairwise, without any impact on total cost.

27. (a) Some goods are such that many economic agents can derive utility from consuming it simultaneously. Opera house, sewage system and railway connection are examples of goods that are still of value to others after someone has used them. An example of a good that does not have the property is a chocolate bar.

The benefit of providing such good is the sum of the individual users' or consumers' benefits, which are calculated below for the projects considered in the exercise:

Project	(O) Opera	(S) Sewage	(A) Airport railway
Total cost	300	250	200
Total benefit	345	190	235

Whenever the cost of provision is less than the total benefit, provision is efficient. Therefore opera and rail connection should be invested in.

- (b) Costs are shared evenly between the five municipalities. Under majority rule there must be at least three municipalities for which the share of costs is less than the municipality's gross benefit for the project to be executed. For opera, the cost per municipality is 60 M€. Rosicruce, Uqbar and Orbis Tertius have greater gross benefits and the metropolitan area will get its opera house under majority rule. Only Uqbar and Tlön would support sewage upgrade while Macondo and Tlön would stand behind railway connection by the same logic. These projects will not materialize. Since each project had opposition with a maximum of three municipalities supporting a single project, none of the projects will pass unanimity rule.

- (c) We have four different combinations of projects, whose costs and benefits are:

Project	O&S	O&A	S&A	O&S&A
Total cost	550	500	450	750
Macondo City	15	115	140	135
Rosicruce	160	150	70	190
Uqbar	155	115	70	170
Tlön	115	120	135	185
Orbis Tertius	90	80	10	90

For the project combinations, costs per municipality are 110, 100, 90 and 150, respectively. Both sewage upgrade and railway connection will pass majority vote when coupled with opera. The bundle of all three projects would also pass majority vote.

28. (a) The efficient amount of spending on courtyard beauty is the amount q at which marginal costs equal aggregate marginal benefit of the shareholders. We begin by defining the aggregate marginal benefit, using the individual marginal benefits given in the exercise. As the shareowners are 100 in total, and we now that $n_B = 3n_a$, the housing company has 25 aesthetes (A) and 75 busybodies (B).

$$\begin{aligned}
 P(q) &= \sum_i P_i(q), i = A, B \\
 &= P_A(q) + P_B(q)
 \end{aligned}$$

In doing this, we need to pay attention to possible kinks in the aggregate demand function. As defined, none of the shareholders ever see beautification as a bad, from which follows that marginal benefit is ≥ 0 . Noting this, the aggregate demand function becomes:

$$P(q) = \begin{cases} 25P_A(q) + 75P_B(q), & 0 \leq q < 5 \\ 25P_A(q), & 5 \leq q < 20 \end{cases}$$

$$= \begin{cases} 12.5 - 1.5q, & 0 \leq q < 5 \\ 5 - 0.25q, & 5 \leq q < 20 \end{cases}$$

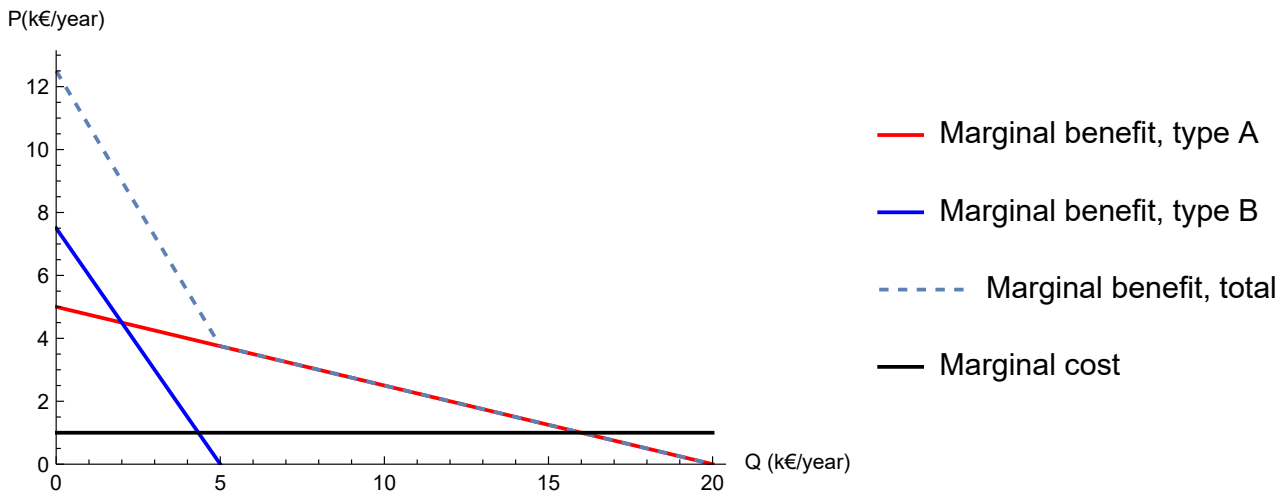

Figure 32: Aggregated marginal benefits for spending on beautification in question 28.

The efficient amount of spending can be solved from $P(q) = MC(q)$. By inspecting Figure 32 we see that the marginal cost line intersects the marginal benefit curve at the lower part, where only aesthetes (type A) value additional spending. Hence, we can solve for the efficient number of hours as follows:

$$5 - 0.25q = 1 \Leftrightarrow$$

$$0.25q = 4 \implies$$

$$q^* = 16$$

- (b) As all costs are shared equal among shareholders and the amount is decided by majority vote, we can expect the final spending to follow the preferences of the majority group, in this case the busybodies (type B). When decided upon, everyone in the housing company follows the decision. The realized amount of spending can

be solved like this:

$$\begin{aligned} 100P_B(q) &= MC(q) \Leftrightarrow \\ 10 - 2q &= 1 \Leftrightarrow \\ 2q &= 9 \implies \\ q^* &= 4.5 \end{aligned}$$

The spending levels are substantially lower than the efficient level found in part 28a.

- (c) Average surplus is given by the area below the demand curve, subtracted by the cost paid by the consumer, and finally divided by all individuals. In part 28b, the individual surplus is as follows:

$$CS_i(q^*) = \frac{1}{100} \left(\frac{1}{2}(100(P_B(0) \times q^*) - q^*) \right) = \frac{1}{100} \left(\frac{1}{2}(10 \times 4.5) - 4.5 \right) = 0.18$$

In the new situation where individuals self-select into housing companies, the surplus of the busybodies is not affected, as they also previously were spending according to their optimum. For aesthetes however, the self-selection leads to a substantial increase in individual surplus. In the new situation, individuals of type A will face the following amount of spending:

$$\begin{aligned} 100P_A(q) &= MC(q) \Leftrightarrow \\ 20 - q &= 1 \implies \\ q^* &= 19 \end{aligned}$$

The individual surplus will following that, calculating as above, be:

$$CS_i(q^*) = \frac{1}{100} \left(\frac{1}{2}(100(P_A(0) \times q^*) - q^*) \right) = \frac{1}{100} \left(\frac{1}{2}(20 \times 19) - 19 \right) = 17.1$$

To conclude, individuals in minority in their original company will benefit from the new system, but individuals who were in minority will not be affected.²

Additional comment: The specialization of different housing companies into providing different levels of beautification is related to the idea of the Tiebout model, briefly discussed in class. One problem with public goods is that everyone living in the same locality must choose exactly the same level of public goods. If there are multiple jurisdictions offering different bundles of public goods this improves welfare simply by allowing for more than one choice. The perfect outcome in part 28c, where everyone got exactly their preferred choice of public goods, can only happen if there are more jurisdictions than there are individual preference types.

²This final conclusion and a reasonable motivation is enough to earn full points for part 28c, the calculations are mostly illustrative.

29. (a) The equilibrium after the tax cut is

$$\begin{aligned} P^S(q) &= P^D(q) \Leftrightarrow \\ 2q &= 200 - 0.5q \implies \\ q_a^* &= 80 \implies \\ p_a^* &= 160. \end{aligned}$$

Before, with the 40 TD/TWh tax, there's equally big wedge between the supply and the demand in the equilibrium:

$$\begin{aligned} P^S(q) + 40 &= P^D(q) \Leftrightarrow \\ 2q + 40 &= 200 - 0.5q \implies \\ q_b^* &= 64 \implies \\ p_b^* &= 168. \end{aligned}$$

Welfare is calculating consumer surplus, producer surplus and the change in tax revenue together.

After the cut $W_a = CS_a + PS_a + T_a = ((200 - 160)80/2) + (160 \times 80/2) + 0 = 8000$.

Before, $W_b = CS_b + PS_b + T_b = ((200 - 168)64/2) + ((168 - 40) \times 64/2) + 40 \times 64 = 7680$.

Change in welfare is $W_a - W_b = 320$.

- (b) The welfare only changes through changes in the equilibrium quantities as long as the tax revenue isn't used for something useful. The traded quantity remains unchanged, so does the welfare generated in the market. As the tax is removed, the government revenue goes to zero and this is transferred to the producers.
- (c) In the long-run equilibrium,

$$\begin{aligned} P_{LR}^S(q) &= P^D(q) \Leftrightarrow \\ 80 + 0.75q &= 200 - 0.5q \implies \\ q_{LR}^* &= 96 \implies \\ p_{LR}^* &= 152. \end{aligned}$$

The price decreases from 168 to 152 TD/TWh. The government still doesn't earn a penny so the decrease in government revenue is $40 \times 64 = 2560$.

- (d) See Figure 33.

30. (a) With a binding price ceiling, there are more consumers who are willing to purchase at the market price than suppliers that are willing to supply. The situation described here corresponds the best-case scenario where those who value the electricity the most get to purchase.

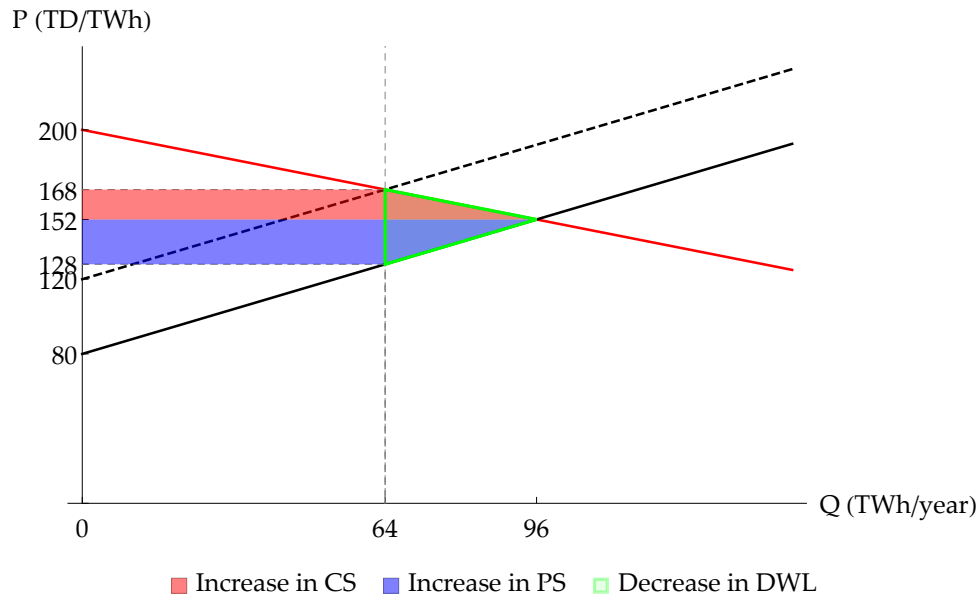

Figure 33: The figure asked for in part 29d.

In the absence of the ceiling, the equilibrium is

$$\begin{aligned}
 P^S(q) &= P^D(q) \Leftrightarrow \\
 40 + 2q &= 200 - 0.5q \implies \\
 q^* &= 64 \implies \\
 p^* &= 168
 \end{aligned}$$

Producer surplus is $PS = 64(168 - 40)/2 = 4096$ and consumer surplus $CS = 64(200 - 168)/2 = 1024$ and welfare the sum of these two, 5120.

The equilibrium quantity under the ceiling is

$$\begin{aligned}
 P^S(q) &= 120 \Leftrightarrow \\
 40 + 2q &= 120 \implies \\
 \hat{q}_b &= 40.
 \end{aligned}$$

Producer surplus is $PS = 40(120 - 40)/2 = 1600$ and consumer surplus (a shape of trapezoid) $CS = 40((200 - 120) + ((200 - 40 \times 0.5) - 120))/2 = 2800$ and welfare the sum of these two, 4400. Welfare is decreased by 720.

- (b) The situation described here corresponds the worst-case scenario where those who value the electricity the least get to purchase. Quantity traded and producer surplus remain the same.

Consumer surplus is $CS = 40(140 - 120)/2 = 400$ and welfare 2000. Welfare is decreased by 3120.

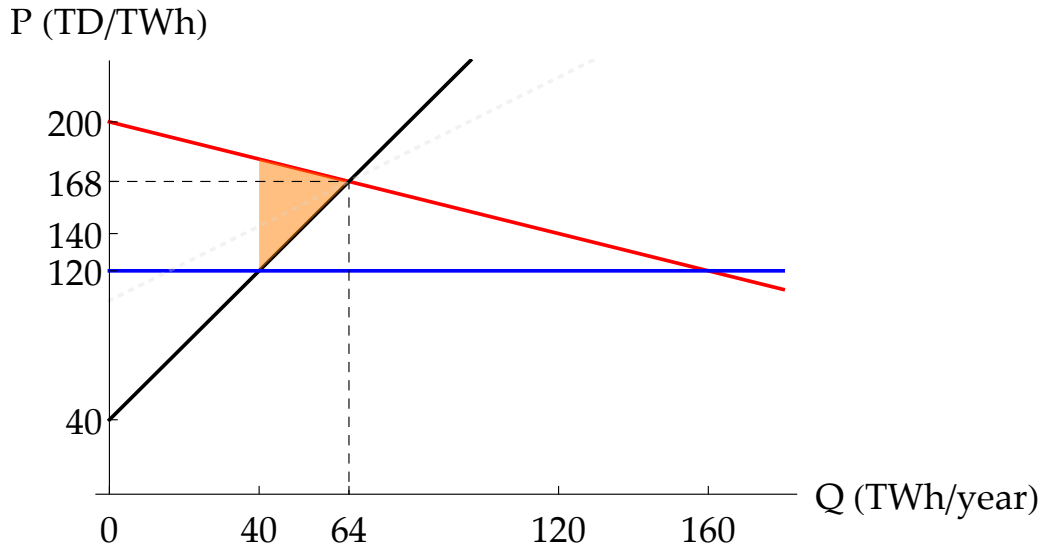

Figure 34: The best-case scenario for welfare in 30c.

- (c) The best-case scenario deadweight loss is highlighted in Figure 34. The worst-case scenario, with deadweight highlighted in green in Figure 35. None of the consumers that would've bought without the ceiling get to purchase now. Consumer surplus solely consists of the grey area. Those consumers wouldn't have purchased in the absence of the ceiling since their valuation is less than 168, the competitive market price.

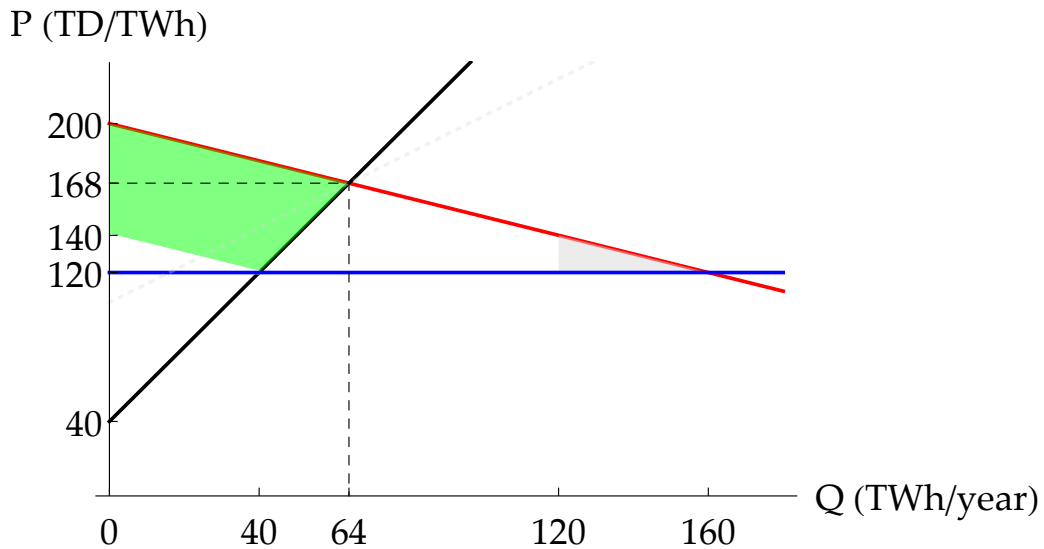

Figure 35: The worst-case scenario for welfare in 30c.

(d) The long-run equilibrium quantity under the ceiling is

$$\begin{aligned} P_{LR}^S(q) &= 120 \Leftrightarrow \\ 104 + 2 &= 120 \implies \\ \hat{q} &= 16. \end{aligned}$$

Consumer surplus (a similar trapezoid as in 30c, only truncated at the new equilibrium quantity $q = 16$ rather than $q = 40$) is $CS = 40((200 - 120) + ((200 - 16 \times 0.5) - 120))/2 = 1216$. Consumer surplus increases as $1216 - 1024 = 192 > 0$.

31. (a) First solve the equilibrium quantity Q^* and surplus without tax from the equation

$$P^D(q) = P^S(q):$$

$$100 - 30q = 5 + 15q$$

$$45q = 95$$

$$Q^* = 95/45 = 19/9 \text{ tons}$$

$$P^* = 5 + 15Q^* = 110/3 \text{ Strubl}$$

Calculate surpluses:

$$CS = (100 - 110/3)(19/9)/2 \approx 66.9$$

$$PS = (110/3 - 5)(19/9)/2 \approx 33.4$$

$$W = CS + PS = 100.3$$

Next solve the equilibrium Q_t^* and the surpluses with tax t from equation $P^D(q) = P^S + t(q)$:

$$100 - 30q = 5 + 15q + t$$

$$45q = 95 - t$$

$$Q_t^*(t) = \frac{95-t}{45}$$

$$P_D^*(t) = 100 - 30 \frac{95-t}{45} = 100 - \frac{190-2t}{3}$$

$$P_S^*(t) = 5 + 15 \frac{95-t}{45} = 5 + \frac{95-t}{3}$$

When tax $t = 30$ we arrive the equilibrium quantity and price:

$$Q_t^* = \frac{95-30}{45} = 1.45$$

$$P_D^* = 100 - 30 \frac{95-30}{45} = 56.6$$

$$P_S^* = 5 + 15 \frac{95-30}{45} = 26.6$$

The surpluses now need to take into account tax revenue T :

$$CS_t = (100 - 56.6)(1.45)/2 \approx 31.5$$

$$PS_t = (26.6 - 5)(1.45)/2 \approx 15.7$$

$$T = tQ_t^* = 30 \times (1.45) \approx 43.5$$

$$W_t = CS_t + PS_t + T \approx 90.7$$

The welfare effect of the tax is the difference between the surpluses, with and without the tax.

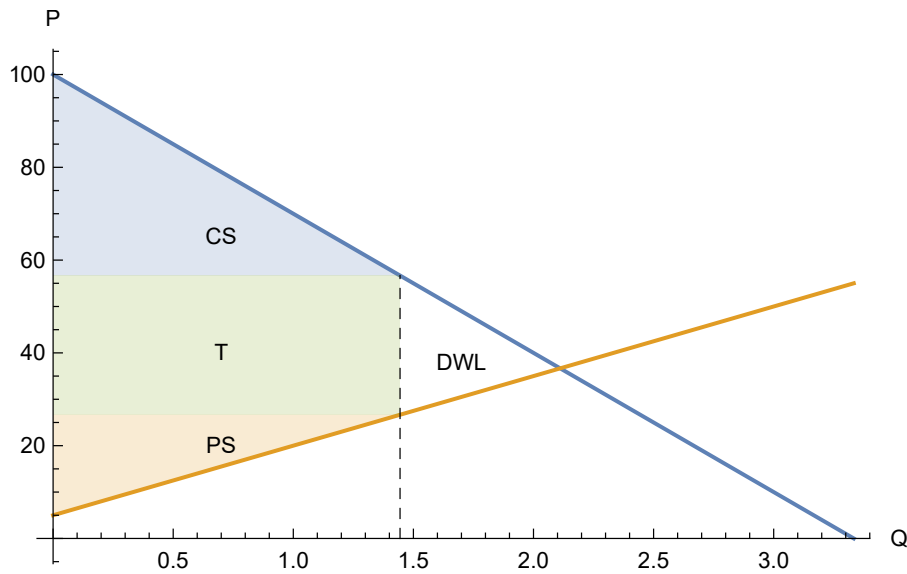

Figure 36: Surpluses from trade when $t = 30$ in 31a.

$$\Delta CS \approx 31.5 - 66.9 \approx -35.4$$

$$\Delta PS \approx 15.7 - 33.4 \approx -17.7$$

$$\Delta T \approx 43.5 - 0 \approx 43.5$$

$$\Delta W \approx 90.7 - 100.3 \approx -9.6$$

With the tax, the total surplus is about 9.6 thousand Strubls smaller. Molvania gains 43.5 thousand Strubls in tax revenue, but this income is gained at the expense of consumer and producer surplus. The changes induced by the tax are demonstrated in figure 36.

- (b) The relationship between tax rates and tax revenue is obtained from the Laffer-curve. First we need to find the functional form of the Laffer-curve $T(t)$:

$$T(t) = tQ_t^*(t) = t \frac{95-t}{45} = \frac{95t-t^2}{45} = -\frac{t^2}{45} + \frac{95}{45}t$$

As a downward opening parabola, tax revenues will first increase and then decrease. Intuitively, taxing will lower the demand until a point where increasing the tax rate no longer offsets the loss of demand. Figure 37 displays the Laffer-curve graphically. The rest is straightforward: Find the maximum tax revenue by differentiating $T(t)$ with respect to t :

$$T'(t) = \frac{95}{45} - \frac{2t}{45} = 0$$

$$t = 95/2 = 47.5$$

$$T(47.5) \approx 50.14$$

The tax revenue is maximized when Nikod sets the tax rate at $t = 47.5$. The total tax revenue is 50 140 Strubl.

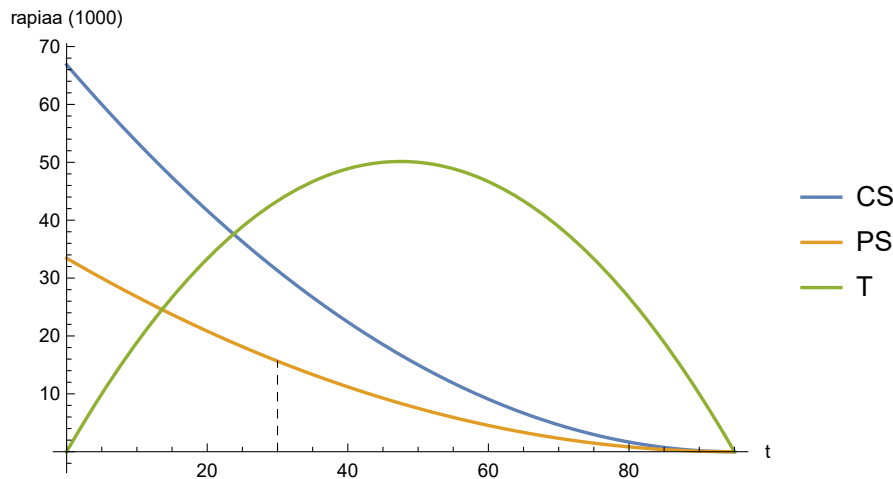

Figure 37: The Laffer curve in 31b.

- (c) The marginal benefit of tax is now 1.5 (earlier it was 1). Now the government wants to maximize the welfare of the population, i.e. the total surplus. The function to be maximized (wrt t) is then

$$W(t) = CS(t) + PS(t) + 1.5T(t)$$

where

$$CS(t) = (100 - (100 - \frac{190-2t}{3})) \frac{95-t}{45} / 2$$

$$PS(t) = ((5 + \frac{95-t}{3}) - 5) \frac{95-t}{45} / 2$$

$$1.5T(t) = 1.5 \frac{95t-t^2}{45}$$

$$\begin{aligned} W(t) &= \frac{190-2t}{3} \frac{95-t}{45} / 2 + \frac{95-t}{3} \frac{95-t}{45} / 2 + 1.5 \frac{95t-t^2}{45} \\ &= \frac{(95-t)^2}{135} + \frac{(95-t)^2}{270} + 1.5 \frac{95t-t^2}{45} \end{aligned}$$

Setting the derivative to zero and solving for t :

$$W'(t) = -\frac{2(95-t)}{135} - \frac{2(95-t)}{270} + \frac{142.5-3t}{45} = 0$$

$$t^* = 23.75$$

The results are analyzed graphically in Figure 38.

As shown, the welfare optimizing tax is larger than zero $t = 23.75 > 0$. This is due to the assumption that tax dollars are worth more than their nominal value. In this example, it can be thought of as a way to model the value of public goods that would be produced inefficiently in the market. In other words, taxing can increase total welfare if tax dollars are used to correct market imperfections.

32. Throughout this exercise, all curves, surpluses etc in the absence of any subsidies are denoted with subscript 0. In the case of \$100 producer (consumer) surplus as in 32a (32b), denote the altered measures with subscript 1 (2).

In the case of \$200 producer subsidy as in 32c we use subscript 3. When government intervenes by purchasing milk on the market 32d we use subscript 4.

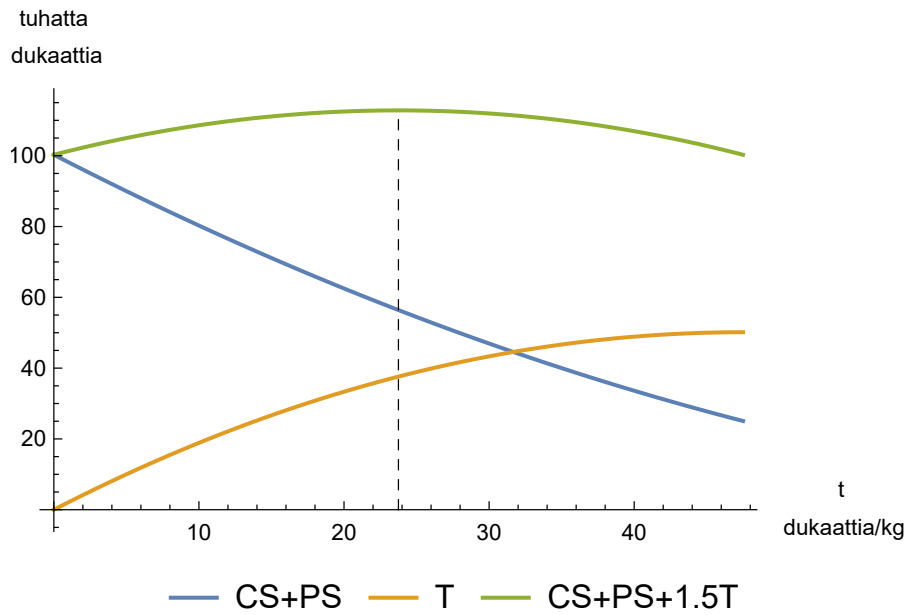

Figure 38: Optimal taxation under public good provision in part 31c.

All the quantities are in kilotons per year. All surplus measures are yearly.

- (a) Let's start with deriving inverse demand and supply curves in the absence of the subsidy or other interventions: $Q^d(p) = 20 - 0.05p \implies p_0^d(q) = 400 - 20q$, $Q^s(p) = 0.2p - 40 \implies p_0^s(q) = 5q + 200$.

Equilibrium without subsidy would be $p_0^d(q) = p_0^s(q) \iff 400 - 20q = 5q + 200 \implies q_0^* = 8 \implies p_0^* = p_0^d(8) = 240$.

Subsidy shifts supply curve downwards: $p_1^s(q) = p_0^s(q) - 100 = 5q + 100$. New equilibrium is obtained as $400 - 20q = 5q + 100 \implies q_1^* = 12 \implies p_1^* = p_0^d(12) = 160$.

In the absence of the subsidy, $CS_0 = (400 - 240) \times 8/2 = 640$, $PS_0 = (240 - 200) \times 8/2 = 160$. Welfare is $W_0 = CS_0 + PS_0 = 640 + 160 = 800$.

With producer subsidy, $CS_1 = (400 - 160) \times 12/2 = 1440$, $PS_1 = (160 - 100)(12 - 0)/2 = 360$. Deadweight loss is $(12 - 8)(240 - 160)/2 + (12 - 8)(5 \times 12 + 200 - 240)/2 = 200$. Total amount of subsidy paid is $G = 12 \times 100 = 1200$ and therefore $W_1 = CS_1 + PS_1 - G_1 = 600$.

Therefore the welfare effects of producer subsidy are $\Delta_1 CS = CS_1 - CS_0 = 1440 - 640 = 800$, $\Delta_1 PS = PS_1 - PS_0 = 360 - 160 = 200$ and $\Delta_1 W = \Delta_1 PS + \Delta_1 CS - G_1 = -DWL_1 = -200$.

- (b) Changing the nominal incidence of a subsidy does not change its welfare effects. If you go through the trouble of recalculating everything (not necessary) you find that all areas that capture the monetary values of the components of welfare have the same shape and the same area as when the subsidy was paid to producers.

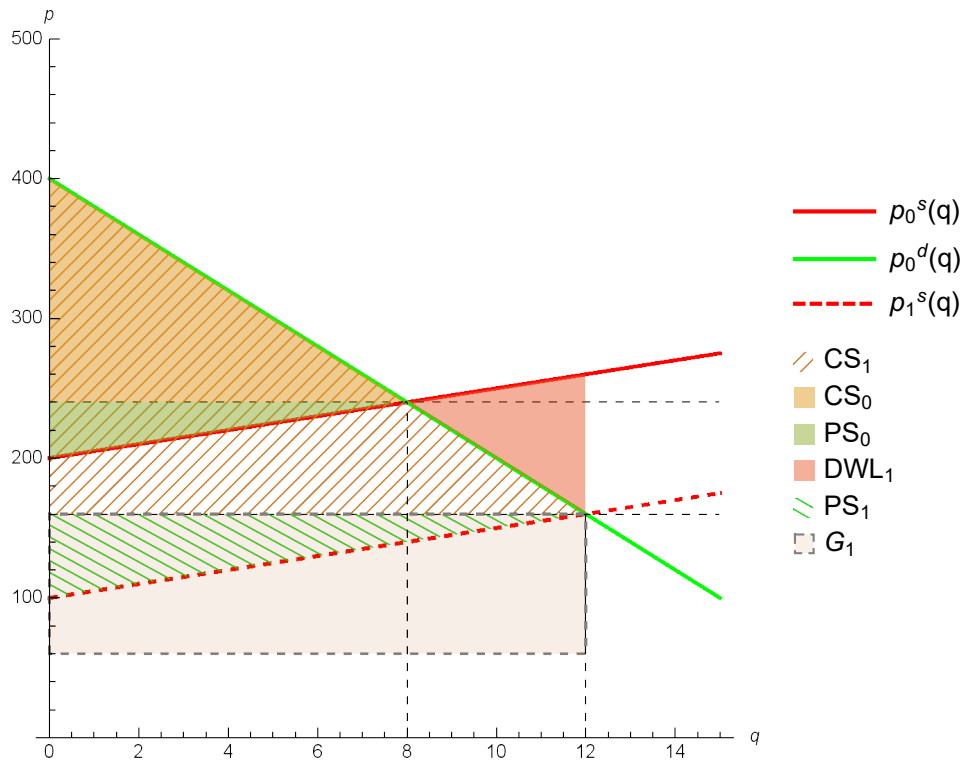

Figure 39: Welfare effects of a \$100/kt unit subsidy, paid to producers in 32a.

- (c) During the Urban party’s reign there are no policy interventions in the market so their welfare effects are zero.

During Farmers’ party reign, subsidy shifts supply curve downwards: $p_1^s(q) = p_0^s(q) - 200 = 5q$. The setting is very similar to Figure 39: supply curve only has now shifted another 100 units downwards. New equilibrium is obtained as $400 - 20q = 5q \implies q_1^* = 16 \implies p_1^* = p_0^d(16) = 400 - 20 \times 16 = 80$.

For consumer and producer surplus we obtain $CS_3 = (400 - 80) \times 16/2 = 2560$ and $PS_3 = (80 - 0)(16 - 0)/2 = 640$. Total amount of subsidy paid is $G_3 = 16 \times 200 = 3200$ and therefore $W_3 = CS_1 + PS_1 - G_3 = 0$.

In half of the years there’s no welfare loss, in the other half the loss is $\Delta_3 W = W_3 - W - 0 = -800$, yielding an average yearly loss of $(800 + 0)/2 = 400$.

Notice that the average welfare loss from a subsidy that varies across years is much higher than was the welfare loss from a subsidy that is stable at the level of the average subsidy across years 100. This is a general result: the marginal welfare loss from a subsidy (or a tax) increases as the level of the subsidy (or a tax) gets higher.

- (d) The government chooses a point on the supply curve where the desired level of surplus is obtained and sizes its purchases accordingly. The only point on the supply curve that yields exactly the same surplus as in 32a is the point we obtained in (a), which

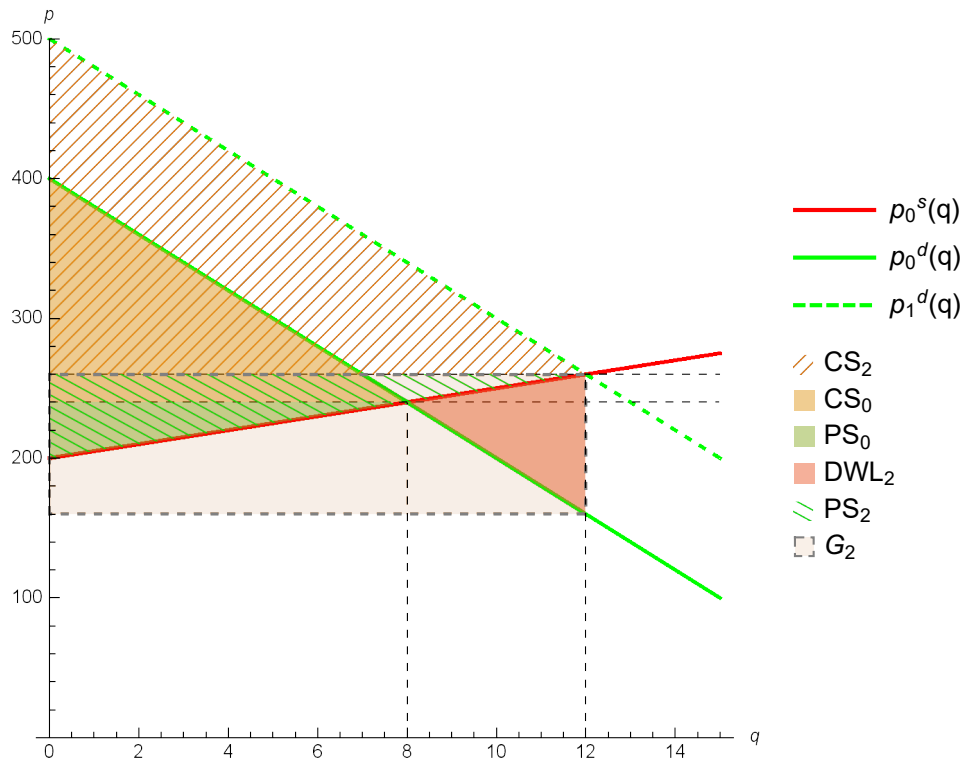

Figure 40: Welfare effects of a \$100/kt unit subsidy, paid to consumers in 32b.

is easily verified:

$$\begin{aligned}
 PS_4 = PS_1 = 360 &\iff \\
 (200 + 5q - 200)(q - 0)/2 = 360 &\iff \\
 (5/2)q^2 = 360 \stackrel{q>0}{\implies} & \\
 q_4^* = 12 &\implies \\
 p_4^* = p_0^s(12) = 200 + 5 \times 12 = 260 &
 \end{aligned}$$

At this price, quantity sold to consumers is $Q^d(260) = 20 - 0.05 \times 260 = 7$. Government will purchase the remaining 5 kilotons.

Counting in the exports, government spending is $G = (260 - 40) \times 5 = 1100$. Consumer surplus is $CS_4 = (400 - 260)(7 - 0)/2 = 490$ and change in consumer surplus by $\Delta_4 CS = 490 - 640 = -150$. Change in producer surplus is $\Delta_4 PS = 360 - 160 = 200$. In total, the effect of the purchases on welfare is $\Delta_4 W = W_4 - W_0 = 490 + 360 - 1100 - 800 = -1050$.

In general, giving the producers a monetary transfer is a cheaper way to increase producer welfare than incentivizing them to produce costly output that is sold at a loss. Now in addition to paying the producers the government also pays for inefficient excess production.

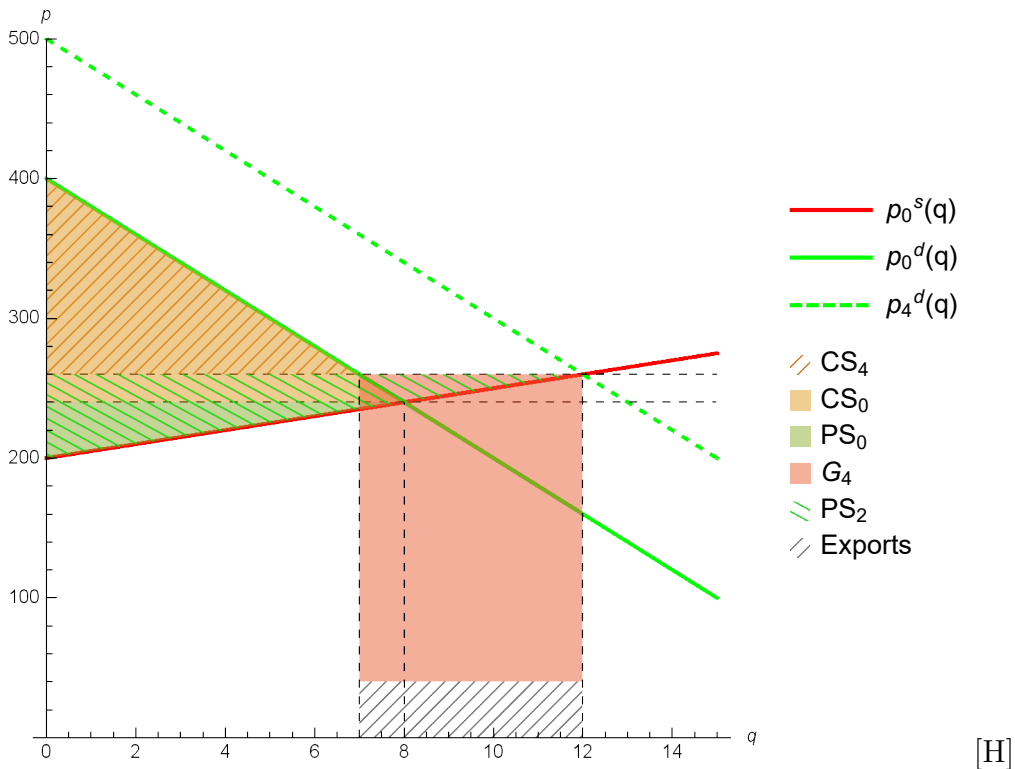

Figure 41: Welfare effects of a price support in 32d.

33. (a) Tax revenue is defined as $T(t) = tQ^t(t)$. Equilibrium quantity can be solved in the familiar demand-supply-framework, taking the tax into account as a shift in supply (or in demand, in which case the tax is subtracted from the inverse demand). The general solution is:

$$\begin{aligned}
 P^s(q) + t &= P^d(q) \Leftrightarrow \\
 2q - t &= 200 - \frac{q}{2} \implies \\
 Q^t(t) &= 80 - \frac{2}{5}t
 \end{aligned}$$

Note that we now defined the equilibrium quantity in terms of t , a function that will be used later in the exercise. With the given tax level $t = 60$, the equilibrium quantity is:

$$Q^t(60) = 80 - \frac{2}{5}60 \implies q^* = 56.$$

With this equilibrium quantity, $T(60) = 60Q^t(60) = 60 \times 56 = 3360$. This is the green area in figure 42.

- (b) Even if the nominal tax is set on employers, the incidence depends on the elasticity of demand and supply for the good, which in this case is labor. The incidence can

be described by defining how much of the total labor tax revenue is paid by the employers, and how much is paid by the employees, most conveniently as shares of the total revenue. In the green area of the graph (figure 42) we see total labor tax revenue. The share paid by consumers (employers) is the share of the green tax revenue area that would have been part of the consumer surplus and the employee share is similarly what would have been part of the producer surplus, in the situation with $t = 0$.

Without the tax, the equilibrium price would be 160:

$$\begin{aligned}
 P^s(q) &= P^d(q) \Leftrightarrow \\
 2q &= 200 - \frac{q}{2} \implies \\
 q^* &= 80 \implies p^* = 2q^* = 160.
 \end{aligned}$$

The consumer/employer share of the total tax is the part above $p = 160$ and below what they pay in the market with the tax, which is $p^d(56) = 200 - \frac{56}{2} = 172$. This area can be seen in figure 42 and its size is $T_{CS} = q_t^*(p^* - p^s) = 56(172 - 160) = 672$. As a share of the total tax revenue, this is $672/3360 = 20\%$. The producers/employees will pay the rest, which is most easily calculated as $100 - 20 = 80\%$. The tax is legally on employers, but in reality, most of it is paid by the employees.

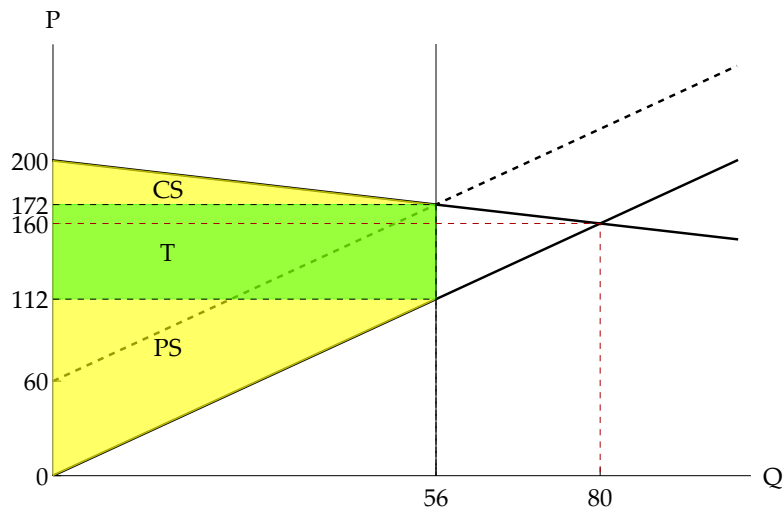

Figure 42: Demand and supply framework for nation A in exercise 33. The colored area (green and yellow) represents the total surplus aka welfare W .

- (c) The new public good considered has a positive direct net benefit. However, it will require a slight increase in the tax level. The cost of this will affect the final effect of introducing the good.

Welfare is defined as $W = CS + PS + T - G$. Marginal costs of public funds (MCPF) is how much it would cost to increase the tax level by a small amount. This is defined

as

$$MCPF(t) = -\frac{W'(t)}{T'(t)}$$

We know by definition that G , existing public spending, can not be changed. This can therefore be excluded from the calculations that follow, as the change will be zero. A change in the tax-level will however affect total surplus and total tax revenue. To calculate how a change in t will affect them, they must be defined as functions of t . For this, we can use the graphical illustration in figure 42 to our help. Total surplus or W excluding G is the trapezoid colored in figure 42. The area of this trapezoid is³:

$$\begin{aligned} W(t) &= \frac{1}{2}(P^d(0) - P^s(0) + t)q_t^*(t) \\ &= \frac{1}{2}(200 + t)(80 - \frac{2}{5}t) \\ &= 8000 - \frac{1}{5}t^2. \end{aligned}$$

This is in other words the total surplus as a function of t . The cost of a small tax increase is:

$$\begin{aligned} MCPF(t) &= -\frac{W'(t)}{T'(t)} \\ &= -\frac{\frac{d}{dt}8000 - \frac{1}{5}t^2}{\frac{d}{dt}80t - \frac{2}{5}t^2} \\ &= -\frac{-\frac{2}{5}t}{80 - \frac{4}{5}t} \\ &= -\frac{-24}{80 - 48} = 0.75 \end{aligned}$$

In the current situation, the marginal cost of a small tax increase is 0.75. The marginal cost of the new public good is 1, resulting in a total cost of $0.75 + 1 < 2$. The benefit is larger than the cost and the total surplus in Nation A would increase with the provision of this new good.

Note: This could also be solved by testing with a small tax increase, ex. $t_{new} = t + 1$. This will affect the tax revenue and the welfare through t and q^* . The marginal cost of the tax increase would then be $MCF = -\Delta W / \Delta T$, where $\Delta W = -24.2$ is the change in welfare and $\Delta T = -31.6$ the change in tax revenue. Thus, $MCF \approx 0.77$ and the conclusion is similar to above.

³The area of a trapezoid is by definition: $A = \frac{(a+b)}{2}h$, where a and b are the parallel bases and h is the height or distance between these.

4 Tools, foundations

34. Reservation price is the lowest price at which the company is willing to supply anything at all. It will make zero profits at reservation price, and would make deficit at lower prices should it operate. All prices are in thousands of euros.

(a) If profits are zero, then it must be that unit price equals average cost:

$$p = TC(1000)/1000 = (500000 + 100000)/1000 = 600.$$

(b) We used a shortcut above, but we could've equally well set profits to zero and solve for price. That is what we do here, with the difference that now the profits are expected:

$$E[\pi(p)] = (p - 100) \times 1000 + (1/2)(200 - 100) \times 2000 - 500000 = 0 \iff p = 500.$$

When calculating expected profits we first figure out, what are all the possible, mutually exclusive states of the world (order, no order), calculate the profits in each state and multiply these profits by the corresponding probabilities (0.5, 0.5). If some cost, for example, is to be paid in any state, we don't have to calculate it into profits in each individual state as here is done with leasing costs.

At reservation price, firm will make profit (deficit) if the order for B gadgets materializes (is canceled), but zero on expectation.

(c) Gadget's price must always exceed or equal marginal cost to be produced, $p_i \geq 100$. Firm will naturally produce a gadget at full capacity if it produces that gadget at all.

Only one of the gadgets is produced when one gadget's price is below that threshold but other gadget's price is high enough alone fixed costs to be covered by sales of that gadget only.

Non-negative profits condition is, as per part 34a, given by $p_A \geq 600$ when $p_B < 100$. Only A is produced with these values.

Condition becomes

$$\pi(p_A, p_B) = -500000 + (p_B - 100) \times 2000 = 0 \iff p_B \geq 350$$

when $p_A < 100$. Only B is produced then.

If $p_A, p_B \geq 100$ condition is written as

$$\pi(p_A, p_B) = -500000 + (p_A - 100) \times 1000 + (p_B - 100) \times 2000 = 0 \iff p_A + 2p_B \geq 700$$

and both gadgets are produced. Figure 43 shows the regions in price space where different acceptance decisions are optimal.

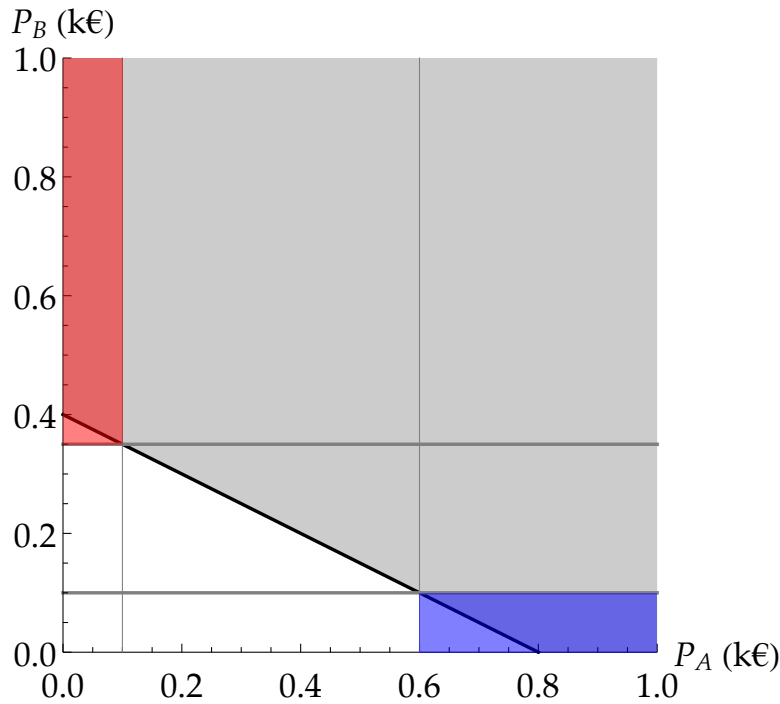

Figure 43: The space of gadget prices in Problem 34. Both deals would be accepted when unit prices $\{p_A, p_B\}$ are in the gray region. In the blue region only A and in the red region only B is accepted.

35. (a) The firm has $4 \times 5 = 20$ working days at its disposal on weekdays, 4 on Saturday and 2 on Sunday, which translate into 10, 2, and 1 pumps, respectively. Since the firm can only install 13 pumps a week, the cost of purchasing a pump is always 1000 €.

Given the different wages for different days, the cost of installing n th pump is the sum of wage expenses and purchase price,

$$c(n) = \begin{cases} 2 \times 150 + 1000, & 1 \leq n \leq 10 \\ 1500, & 11 \leq n \leq 12 \\ 1800, & n = 13. \end{cases}$$

Average costs equals total cost divided by the number of pumps, $\sum_{i=1}^n c(i)/n$, and is plotted along with marginal costs below.

- (b) The firm will only install units whose marginal cost $c(n)$ is less or equal to marginal revenue. Denote the market price for the installed pumps by p . The firm's supply

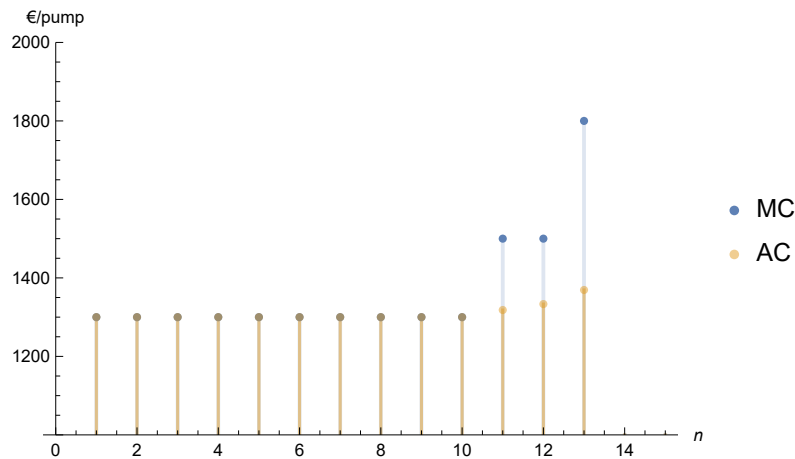

Figure 44: The cost structure of Lämpö Oy in Problem 35.

(i.e. number of units it can install at a marginal cost below p) is

$$n(p) = \begin{cases} 0, & 0 \leq p < 1300 \\ 10, & 1300 \leq p < 1500 \\ 12, & 1500 \leq p < 1800 \\ 13, & 1800 \leq p. \end{cases}$$

$n(1600) = 12$. The firm will generate a revenue of $1600 \times 12 = 19200$ at a cost of $1300 \times 10 + 1500 \times 2 = 16000$, yielding a profit of $19200 - 16000 = 3200$. Total earnings are given by $10 \times 300 + 2 \times 500 = 4000$.

(c) This was answered as part of the answer to 35b.

36. (a) To find the cost function of the farm, start from the berries that are the easiest to pick. First 40 tons of berries can be picked at 10kg/hour. Variable cost, per ton for the first 40 tons of berries, denoted by VC_1 , is:

$$VC_1 = \frac{10\text{€/hour}}{10\text{kg/hour}} = 1\text{€/kg} = 1000\text{€/ton}$$

and for the next 20 tons of berries, denoted by VC_2 , is:

$$VC_2 = \frac{10\text{€/hour}}{5\text{kg/hour}} = 2\text{€/kg} = 2000\text{€/ton}$$

For the last 20 tons of berries, denoted by VC_3 , is:

$$VC_3 = \frac{10\text{€/hour}}{3\text{kg/hour}} \approx 3.333\text{€/kg} = 3333\text{€/ton}$$

Note that we get the cost per ton by scaling up the cost per kilogram by the factor of 1000. Farm's cost function, where Q is in tons and VC is in euros, is:

$$\begin{aligned} VC(Q) &= 1000 \cdot Q && \text{if } Q \leq 40 \\ VC(Q) &= 2000 \cdot Q - 40000 && \text{if } 40 < Q \leq 60 \\ VC(Q) &\approx 3333 \cdot Q - 120000 && \text{if } 60 < Q \leq 80 \end{aligned}$$

Cost function's second part is based on costs at the lower bound, $Q = 40$, plus the additional cost that incurs from the production beyond $Q = 40$. Therefore, production quantity is $Q - 40$ and variable costs are $VC(Q) = 1000 \cdot 40 + 2000 \cdot (Q - 40) = 2000 \cdot Q - 40000$ and the third part follows the same logic so we have $VC(Q) = 1000 \cdot 40 + 2000 \cdot (60 - 40) + 3333.33 \cdot (Q - 60) = 80000 + 3333.33 \cdot (Q - 60) = 3333Q - 120000$. The cost function is depicted graphically in Figure 45.

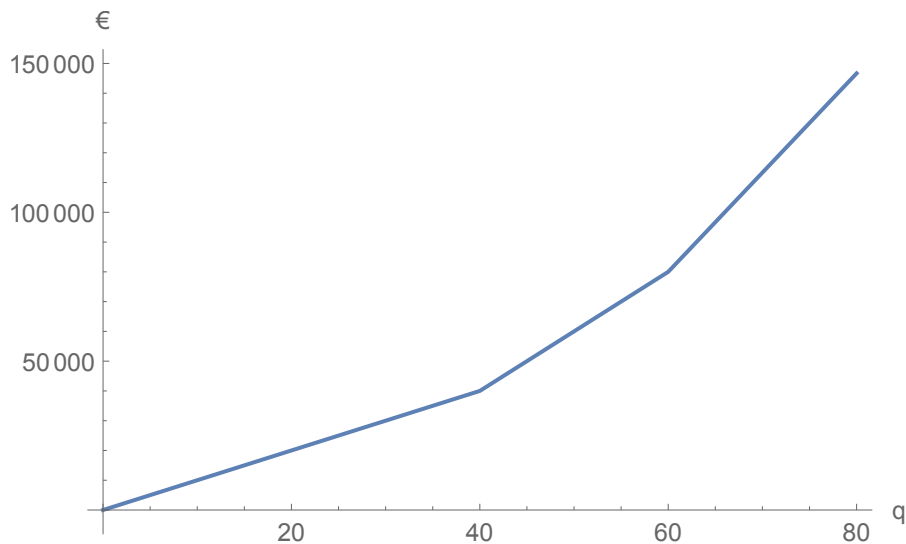

Figure 45: Total cost function of the berry farm in 36a, with costs in € and quantities in tons.

Marginal costs, in € per ton, are:

$$\begin{aligned} MC(Q) &= 1000 && \text{if } Q \leq 40 \\ MC(Q) &= 2000 && \text{if } 40 < Q \leq 60 \\ MC(Q) &\approx 3333 && \text{if } 60 < Q \leq 80 \end{aligned}$$

And average costs, AC , are calculated as $\frac{VC(Q)}{Q}$:

$$\begin{aligned} AC(Q) &= \frac{1000 \cdot Q}{Q} = 1000 && \text{if } Q \leq 40 \\ AC(Q) &= \frac{2000 \cdot Q - 40000}{Q} = 2000 - \frac{40000}{Q} && \text{if } 40 < Q \leq 60 \\ AC(Q) &\approx \frac{3333 \cdot Q - 120000}{Q} = 3333 - \frac{120000}{Q} && \text{if } 60 < Q \leq 80 \end{aligned}$$

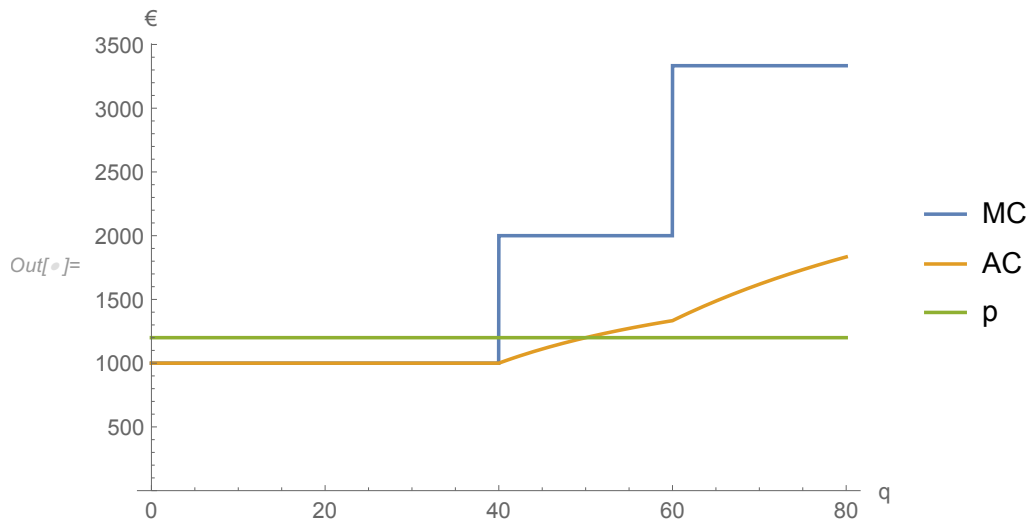

Figure 46: Average cost function, AC , marginal cost function, MC and price per ton, P , in 36a.

- (b) The firm can use the optimality condition, stating that produce until $MC = p$. We have that $P = 1200\text{€}$ per ton. Therefore, $MC < P$ when $Q \leq 40$ and $MC > P$ when $Q > 40$. Therefore, it is optimal to produce until $Q = 40$ tons.

What would be the profits, π and the total earnings, TE of the pickers?

$$\begin{aligned} \pi(Q = 40) &= 40 \cdot 1200 - 40 \cdot 1000 = 8000 \\ TE(Q = 40) &= 40 \cdot 1000 = 40000 \end{aligned}$$

Total profit is 8000€ and total earnings is $40\,000\text{€}$. Note that all farm's costs are pickers' earnings as the only costs are wages.

- (c) First, suppose that the wage rate is now $7.5\text{€}/\text{hour}$. Cost per ton is now:

$$VC_1 = \frac{7.5\text{€}/\text{hour}}{10\text{kg}/\text{hour}} = 0.75\text{€}/\text{kg} = 750\text{€}/\text{ton}$$

and for the next 20 tons of berries, denoted by VC_2 , is:

$$VC_2 = \frac{7.5\text{€}/\text{hour}}{5\text{kg}/\text{hour}} = 1.5\text{€}/\text{kg} = 1500\text{€}/\text{ton}$$

For the last 20 tons of berries, denoted by VC_3 , is:

$$VC_3 = \frac{7.5\text{€}/\text{hour}}{3\text{kg}/\text{hour}} \approx 2.5\text{€}/\text{kg} = 2500\text{€}/\text{ton}$$

With the 7.5€ per hour wage rate, the same applies as in b.) so as we have $P = 1200\text{€}$ per ton, $MC < P$ when $Q \leq 40$ and $MC > P$ when $Q > 40$. Again, it is optimal to produce until $Q = 40$ tons.

What would be the profits, π and the total earnings, TE of the pickers?

$$\begin{aligned}\pi(Q = 40) &= 40 \cdot 1200 - 40 \cdot 750 = 18000 \\ TE(Q = 40) &= 40 \cdot 750 = 30000\end{aligned}$$

Total profit is 18 000€ and total earnings is 30 000€. Lower price only transforms earnings to profits as total production remains the same.

Second, suppose that the wage rate is 12.5€/hour. Cost per ton is now:

$$VC_1 = \frac{12.5\text{€/hour}}{10\text{kg/hour}} = 1.25\text{€/kg} = 1250\text{€/ton}$$

We can see that the easiest to pick berries cost 1250€ per ton to pick up and the price is 1200€ per ton so we have $MC > P$ already for $Q \leq 40$. Therefore, it is optimal to produce zero berries.

Now total profit is 0 € and total earnings is 0 €.

37. Price of electricity is 0.10 €/kWh, and the opportunity cost of capital is a 4 % return. Usage is 2000 h/year (about 5.5h/day). Electricity bill is paid at the end of each year. A device with power x W uses x kWh of electricity per each 1000 hours of use.

- (a) Compare the cost of producing light between these two methods over the next 25 years. Which method would be more cost-efficient?

First, calculate what is the cost for lighting per year using different technologies.

LED has a durability of 50,000 hours so for 2000 hour yearly usage, it's duration is $50,000/2000 = 25$ years.

We can calculate the usage cost for LED per year :

$$C_{LED} = \frac{1 \text{ kWh}}{1000 \text{ hours}} \cdot 2000 \text{ hours} \cdot 0.1 \text{ €/kWh} = 0.2 \text{ €}$$

We know that the investment cost of LED is 24 €. We can discount future costs for using LED lightning to today by using a discount factor that is based on the opportunity cost of capital and is 4%. LED is purchased at the beginning of year and electricity is paid at the end of each year. The present value of costs for LED usage, PVC_{LED} , is:

$$PVC_{LED} = 24 + \frac{0.2}{1.04} + \frac{0.2}{1.04^2} + \frac{0.2}{1.04^3} + \dots + \frac{0.2}{1.04^{25}}$$

An alternative formulation is to use perpetuity (discount future payment forever):

$$PVC_{LED} = 24 + \frac{0.2}{0.04} - \frac{0.2/1.04^{25}}{0.04} \approx 27.12$$

discounting costs forever starting from the end of the first year deducted by discounted costs forever starting 25 years from now (to get present value of costs for years 0-25).

The present value of LED usage for the next 25 years is 27.12 €.

Next, calculate the present value of costs for light bulbs:

Light bulb has a durability of 2,000 hours so for 2000 hour yearly usage, it's duration is $2,000/2000 = 1$ year.

Usage cost per year for light bulb is:

$$C_{LB} = \frac{50 \text{ kWh}}{1000 \text{ hours}} \cdot 2000 \text{ hours} \cdot 0.1 \text{ €/kWh} = 10 \text{ €}$$

The investment cost of light bulb is 1 €. Again, discount future costs from using light bulbs to today by using a discount factor that is based on the opportunity cost of capital and is 4%. Light bulb is purchased at the beginning of each year and electricity is paid at the end of each year. The present value of costs for light bulb usage, PVC_{LB} , is:

$$PVC_{LB} = 1 + \frac{1}{1.04} + \frac{10}{1.04} + \frac{1}{1.04^2} + \frac{10}{1.04^2} + \dots + \frac{1}{1.04^{25}} + \frac{10}{1.04^{25}}$$

and using perpetuity:

$$PVC_{LB} = 1 + \frac{10}{0.04} - \frac{10/1.04^{25}}{0.04} + \frac{1}{0.04} - \frac{1/1.04^{25}}{0.04} \approx 172.84$$

The present value of light bulb usage for the next 25 years is 172.84 €.

- (b) Suppose the price of LEDs is expected to drop by 50% every year. When should the first LEDs be purchased?

It might be optimal to wait before upgrading to LED technology. Next, calculate the present value of costs when waiting for one year before buying LED. This means that lightning is based on light bulbs for the first year after which LED is purchased and used for the following 24 years. The cost of LED after one year is $24 \cdot 0.5 = 12$ €.

$$PVC_{\text{wait 1 year}} = 1 + \frac{10}{1.04} + \frac{12}{1.04} + \frac{0.2}{1.04^2} + \frac{0.2}{1.04^3} + \dots + \frac{0.2}{1.04^{25}}$$

The first term is the cost of purchasing a light bulb, the second term is the present value of the electricity bill at the end of the first year. Third term is the reduced price of LED after 1 year (50% lower) and the fourth term is the usage cost of LED after 2 years.

Again, we can write the terms after the first three terms using perpetuity:

$$PVC_{\text{wait 1 year}} = 1 + \frac{10}{1.04} + \frac{12}{1.04} + \frac{0.2/1.04}{0.04} - \frac{0.2/1.04^{25}}{0.04} \approx 25.09$$

So the present value of cost when using light bulbs for one year and then buying LED and using it after that is 25.09€.

Next, calculate the present value for waiting two years, when the cost of LED is $24 \cdot 0.5 \cdot 0.5 = 6$ €:

$$PVC_{\text{wait 2 years}} = 1 + \frac{10}{1.04} + \frac{1}{1.04} + \frac{10}{1.04^2} + \frac{6}{1.04^2} + \frac{0.2/1.04^3}{0.04} - \frac{0.2/1.04^{25}}{0.04} \approx 29.12$$

So the present value of cost when using light bulbs for two years and then buying LED and using it after that is 29.12 €.

As $PVC_{\text{wait 1 year}} > PVC_{LED} > PVC_{\text{wait 2 years}}$, it is optimal to wait for one year rather than buying LED immediately or after 2 years.

38. (a) We need to calculate the present value of a stream of yearly payments of \$1, starting in the first year and lasting for 1 billion years.

A repeating cash flow v that lasts for T years is equivalently (and more conveniently for discounting) interpreted as a perpetual flow that starts this year, minus another perpetuity starting $T + 1$ years from now. Using the present value formula for a perpetuity, this results in

$$PV(v, r, T) = \frac{v}{r} - \frac{v}{r} \frac{1}{(1+r)^T} = \frac{v}{r} \left(1 - (1+r)^{-T}\right)$$

where the negative perpetuity was discounted by a further T years. Plugging in the values $v = 1$, $r = 0.03$ and $T = 10^9$ this formula yields a present value of \$33.33.⁴

- (b) Let's find the smallest number of years T such that the present value of \$1 per year for T years, discounted at $r = 3\%$, equals 99% of the present value of the billion year stream.

$$\begin{aligned} \frac{1}{0.03} \left(1 - (1.03)^{-T}\right) &> 0.99 \times 33.33 \implies \\ 1 - (1.03)^{-T} &> 0.03 \times 0.99 \times 33.33 = 0.99 \implies \\ 1 - 0.99 &> 1.03^{-T} \iff \\ \log(0.01) &> -T \log(1.03) \implies \\ \frac{\log(0.01)}{\log(1.03)} &> -T \implies \\ \frac{-4.605}{0.0296} &> -T \implies \\ 155.8\dots &< T \end{aligned}$$

Therefore the smallest integer number of years needed is 156.

⁴In fact, the present value would be the same to the nearest cent even if the flow only lasted for 300 years.

39. (a) Let's assume that Lenape tribe invests at the beginning of year 1626 and the interest rate of 2018 has been paid, so the duration of the investment is 392 years. Present value of the investment at 2.5% interest is:

$$PV = 0.6 \times (1 + 0.025)^{392} \times 500 \approx 4\,800\,000$$

The present value is approximately 4.8 million USD.

What if the interest rate was 5% per year? At 5.0 % interest, the present value is:

$$PV = 0.6 \times (1 + 0.05)^{392} \times 500 \approx 61\,000\,000\,000$$

The present value is approximately 61 billion USD.

In this exercise, one can assume that the number of years is 393 years, 392 or 391 years.

- (b) How high should a constant rate of return on the Lenape silver deposit had to have been for their wealth to now equal to 1 trillion (10^{12}) USD? We can solve the required rate of return from the equation:

$$\begin{aligned} PV &= 10^{12} \\ 0.6(1+r)^{392}500 &= 10^{12} \\ (1+r)^{392} &= \frac{10^{12}}{300} \\ 392 \log(1+r) &= \log(10^{12}/300) \\ 392 \log(1+r) &= \log(10^{12}/300) \\ \log(1+r) &= \frac{\log(10^{12}/300)}{392} \end{aligned}$$

From the definition of logarithm, $\log_a(x) = b \iff a^b = x$, we have:

$$\begin{aligned} 1+r &= 10 \exp\left\{\frac{\log(10^{12}/300)}{392}\right\} \approx 1.0575 \\ r &\approx 0.0575 = 5.75\% \end{aligned}$$

The required rate of return is about 5.8 %.

40. Here, monetary values are expressed as millions of euro (m€). The expected yearly value X of the novelty item, taking into account the risk of malfunction, is

$$E(X) = 0.99 \times 0.1 - 0.01 \times 1 = 0.089.$$

The reservation price should be set equal to the net present value.

- (a) With a discount rate of $r = 5\%$ and the expected yearly value constant forever, using the formula for present value of a perpetuity, the reservation price should be

$$NPV = \frac{E(X)}{r} = \frac{0.089}{0.05} = 1.78.$$

- (b) We know that the novelty item is retired after 40 years. For discounting purposes, this is most convenient to think as a perpetuity that starts next year minus a perpetuity that starts in 41 years.

$$\text{NPV} = \sum_{t=1}^{40} \frac{E(X)}{(1+r)^t} = \frac{E(X)}{r} - \frac{1}{(1+r)^{40}} \frac{E(X)}{r} = 1.52716 \approx 1.53.$$

- (c) Now every year there is a probability of $\rho = 0.01$ that the novelty item is retired. This does not affect the expected value conditional on being sold—it is still $E(X) = 0.089$ as in part 40a. But the probability that the item is still being sold t periods from now is now only $(1 - \rho)^t$. This is the probability of not malfunctioning t years in a row. So the expected profits in year t must now be in effect discounted by

$$\tilde{B}^t = \left(\frac{1 - \rho}{1 + r} \right)^t$$

The situation looks otherwise similar to an ordinary perpetuity, only the discount factor is different from the usual $B = 1/(1+r)$. We can use the same logic that was used to derive the perpetuity discounting formula in the lecture slides (“Decision analysis, time, uncertainty”, page 23), to obtain a modified perpetuity formula⁵

$$\text{NPV} = \frac{\tilde{B}}{1 - \tilde{B}} E(X) = \frac{1 - \rho}{r + \rho} E(X) = \frac{1 - 0.01}{0.05 + 0.01} 0.089 = 1.4685 \approx 1.47.$$

Notice how the usual case of no “end of the world”-risk is the special case $\rho = 0$.

41. The gains (in billions of euros) for the firm in the first T years must be greater or equal to the losses from year $T + 1$ onwards:

$$\sum_{t=1}^T \left(1 \times \frac{1}{(1+r)^t} \right) \geq \sum_{t=T+1}^{\infty} \left(1 \times \frac{1}{(1+r)^t} \right) \Leftrightarrow$$

$$T \geq \frac{\log(2)}{\log(1+r)}.$$

A good way to arrive to the solution is to first calculate the sum of the infinite series starting from $t = 1$. The RHS is that sum postponed by T periods while the LHS is the infinite sum minus the RHS.

Plugging in $r = 0.05$ yields $T \geq 14.20\dots \implies T^* = 15$ years. Mephisto should engage the cost-cutting program if and only if the savings last for 15 years or more.

However, writing down the equation and arriving to the correct number via other means than solving the equation explicitly suffices. This can be done, for example, graphically, as seen in Figure 47.

⁵Insert $\tilde{B} = (1 - \rho)/(1 + r)$ in place of B on page 23 and simplify terms in the resulting NPV.

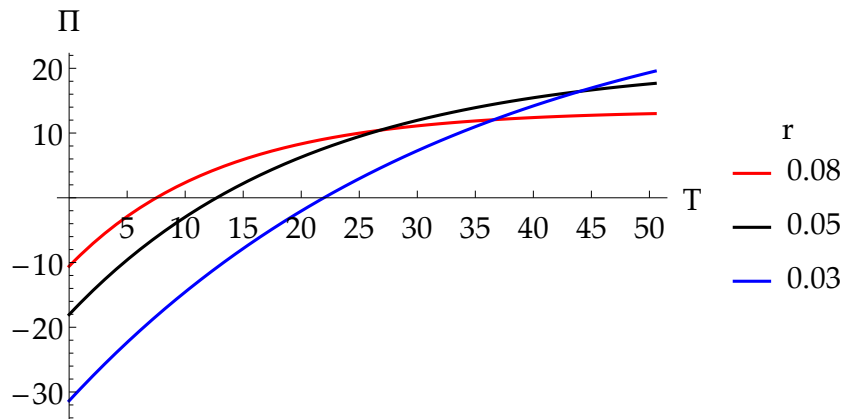

Figure 47: The present value of Mephisto's profits as a function of the turnaround year T under various values of the discount rate r .

42. (a) Observe first that the only choices of m are 16, 32 and 64: nothing is gained if research assistant (RA) hours are used to reduce the peak load from 64 to 32.01. We'll check these three choices separately and choose the option with least costs. No RA labor is needed to get the peak load match the requirements when purchasing 64GB of RAM. That will cost 14400 euros. Labor needed if purchasing 32GB is solved from $60 - 6\sqrt{h} = 32 \iff h = 196/9 \approx 21.8$ and therefore implementing the project will cost $10500 + 21.8 \times 15 \approx 10830$. 16GB: $60 - 6\sqrt{h} = 16 \iff h = 484/9 \approx 53.8$. Project will cost $8250 + 53.8 \times 15 \approx 9060$. The project will be implemented with a 16GB machine and 54 hours of RA labor.
- (b) Now, the team can obtain 64GB of RAM for 1400 euros. No code optimization is needed. 32GB will cost $1200 + 21.8 \times 15 \approx 1530$ and 16GB $1100 + 53.8 \times 15 \approx 1910$. The team will bring in their own laptop with 64GB of RAM.
- (c) If the team hires h hours of RA time it needs to buy $m(h)$ hours of computing time. If an hour of RA time costs c , then total costs are $C(h) = ch + 20m(h)$. The first order condition of the minimization problem is $c + 20m'(h) = 0 \iff c - 20(3/\sqrt{h}) = 0$. The solution is the cost-minimizing choice $h^*(c) = 3600/c^2$. For example, at $c = 15$ euros/hour, $h^*(15) = 16$ hours.
43. (a) First, note that the reservation value $v_i \in [-50, 50]$ of household i here indicates the valuation of housing in the core region relative to the periphery. Hence, willingness to pay for i for renting an apartment in the center is $v_i - (r_c - r_p)$, where r_c and r_p indicate rents in thousands of euros per year, for center and periphery, respectively. Since i) valuation is uniformly distributed in the given interval, ii) we have 1 million households, and iii) $r_c = 10$, we can express demand (in thousands) for apartments

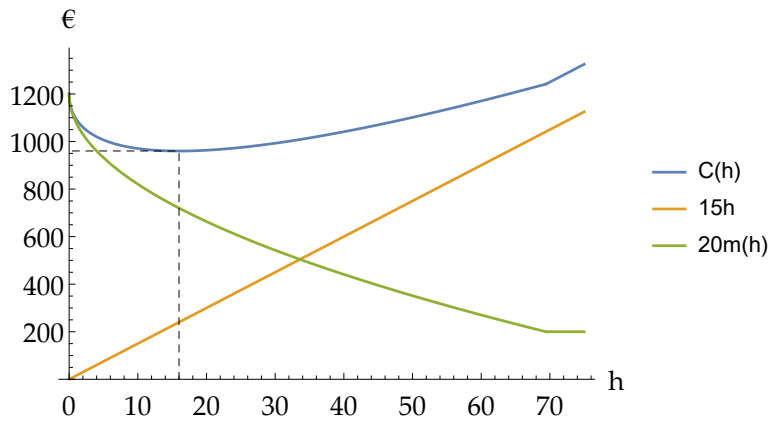

Figure 48: Total costs are minimized where the marginal decrease in computing time costs equals the marginal increase in research assistant costs.

in the center as follows:

$$Q^d(r_c) = (600 - r_c \times 10).$$

Supply, however, is fixed, since no new apartments can be built the core region due to scarcity of land.

Equating supply with demand allows us to solve for the equilibrium rent: $600 - r_c \times 10 = 250 \leftrightarrow r_c^* = 35$. That is, the equilibrium rent for an apartment in the center is 35k/year.

This equilibrium is depicted in figure 49 (where price denotes rent level).

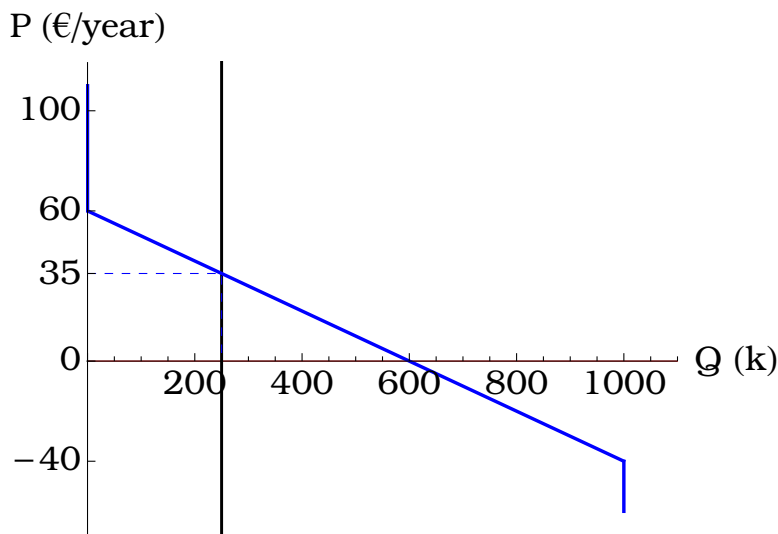

Figure 49: Supply and demand in the rental market of the center region in 43a.

- (b) The price of a house is the present value of the infinite stream of rent payments generated by owning one. Since interest rates in the economy are paid at the end of the year, while rents to apartments are paid during the ongoing year, discounting starts already in the first year. Naturally, cost of capital (or the opportunity cost of investing in a house), is the 5% interest rate, denoted by r .

We can then express the price by making use of the perpetuity formula

$$p_c^* = \frac{r_c^*}{r} = \frac{35}{0.05} = 700,$$

that is, the equilibrium price of an apartment in center is 700k.⁶

- (c) Here the change in demand amounts to a shift in the whole distribution of valuation, that is, from $t = 10$ onward we have $v_i \in [-30, 70]$, and a similar reasoning as in the first subsection means the demand curve in period 10 is

$$Q_{t=10}^d(r_p) = (800 - r_c \times 10).$$

Clearly, as the demand shift occurs discontinuously after 10 years, the response in the rental level should also react discontinuously after 10 years. As supply remains fixed at 250k the whole time, we can solve for higher rent level needed to maintain equilibrium after the demand shock: $Q_{t=10}^d(r_c) = (800 - r_c \times 10) = 250 \leftrightarrow r_c^* = 55$. That is, the rent stays constant at 35 k/year from $t = 0$ up to $t = 10$, at which it jumps to 55k/year, in response to the demand shock.

- (d) Given the new demand curve at $t \geq 10$, we can analogously solve for the supply that is needed to maintain the initial rent level: $Q_{t=10}^d(35) = (800 - 35 \times 10) = q^* \leftrightarrow q^* = 450$. This amounts to an increase of 200k apartments. This shift in the supply curve is visualized in Figure 50.
- (e) We found that the rent will jump from the initial level of 35, to 55 in $t = 10$, after which it stays constant. Denoting the discount factor $\beta = \frac{1}{1+0.05}$, we can express the price in period 0 as follows:

$$p_{t=0}^* = \left[\frac{35}{0.05} - \frac{35}{0.05} \beta^{10} \right] + \beta^{10} \frac{55}{0.05} \approx 946.$$

The first brackets captures the payments of 35k up to period 10, we express it here as the difference of two perpetuities. The rightmost term is the perpetuity that starts in period 10, discounted to period zero.

⁶Note: Here the assumption that rent payments are paid in advance of the ongoing year was also considered as correct. This assumption means the first rent should not be discounted, meaning the price would be given by $\frac{1}{\beta} \frac{35}{0.05} = 735$, where $\beta = \frac{1}{1+0.05}$.

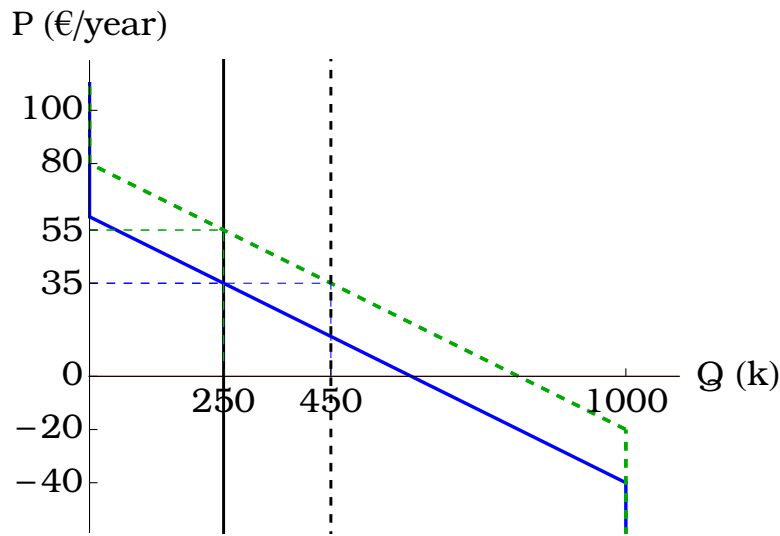

Figure 50: The supply curve from 43d.

More generally, we can use this logic to express the price for any $t < 10$ as:

$$p_t^* = \left[\frac{35}{0.05} - \frac{35}{0.05} \beta^{10-t} \right] + \beta^{10-t} \frac{55}{0.05}, t = 0, \dots, 9.$$

For $t \geq 10$, we can treat the price as a perpetuity with payments of 55k:

$$p_t^* = \frac{55}{0.05}, t \geq 10.$$

Figure 51 plots the price of housing against time. By dividing the price with the rent level, we quickly see that the price-to-rent ratio increases from $t = 0$ up $t = 9$, and then it drops in $t = 10$. Then it stays constant, as price and rents do not change.

This result shows how the price can increase in anticipation of expected future changes while the rent level does not change. This means that an increase in price need not reflect a price bubble despite the discrepancy between price and rent level.

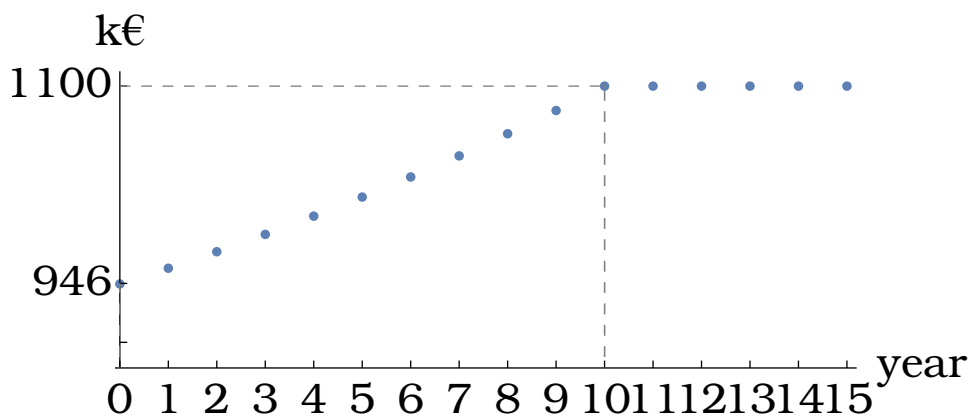

Figure 51: The time series of housing prices in 43e.

44. (a) Here we express the possible outcomes and the respective probabilities in a formal manner. The contestant wins €10 with probability p , $10 \times 2 = 20$ with probability p^2 , $10 \times 2^2 = 40$ with probability p^3 , etc. A mathematical description of the “lottery” faced by a contestant who plans to stop after S rounds is

$$L = (\{10, 20, 40, \dots, 10 \times 2^{S-1}\}, \{p, p^2, p^3, \dots, p^S\}) = \{10 \times 2^{s-1}, p^s\}_{s=1}^{12},$$

where $S \in \{1, \dots, 12\}$.

- (b) If Ukko plans to quit after S questions then his expected utility is

$$EU_{S=s} = p^s u(100000 + 10 \times 2^{s-1}) + (1 - p^s) u(100000),$$

where the Bernoulli utility function gives expected utility by weighting the utilities in each state (in this case failure and success) with the respective probabilities. With $S = 2$,

$$EU_{S=2} = (1/2)^2 \sqrt{100000 + 20} + (1 - (1/2)^2) \sqrt{100000} \approx 316.236.$$

Certainty equivalent is the reservation value in terms of a certain amount of money the decision maker would trade the risky lottery for:

$$\begin{aligned} EU_{S=2} = u(100000 + CE_{S=2}) &\implies 316.236 = \sqrt{100000 + CE_{S=2}} \implies \\ CE_{S=2} &= 316.236^2 - 100000 \approx 5.00. \end{aligned}$$

If Ukko is never going to quit voluntarily then $S = 12$ and his expected utility is

$$EU_{S=12} = (1/2)^{12} \sqrt{100000 + 10 \times 2^{11}} + (1 - (1/2)^{12}) \sqrt{100000} \approx 316.235$$

and

$$EU_{S=12} = \sqrt{100000 + CE_{S=12}} \implies CE_{S=12} = EU_{S=12}^2 - 100000 \approx 4.77.$$

Given his risk preferences, Ukko would expect to be better off with a strategy of quitting after two correctly answered questions than with a never-quit strategy.

- (c) Ukko is risk averse and will prefer the less risky of two gambles with the same expected value. On any round the expected value of the lottery stays the same as the probability of winning halves while the prize doubles. This gives a hint that the earlier Ukko stops the better.

When considering continuing to round $S > 1$, Ukko is deciding between keeping

$$u_{S-1} = \sqrt{w_{S-1}} = \sqrt{100000 + 10 \times 2^{S-2}}$$

or taking a gamble with expected utility of

$$E(u_S) = (1/2)(\sqrt{w_S} + \sqrt{100000}) = (1/2)(\sqrt{100000 + 10 \times 2^{S-1}} + \sqrt{100000}).$$

Ukko's wealth if stopping is exactly halfway between his possible wealths if he continues. Because of concavity of the utility function, it increases faster at lower values of wealth (this is the definition of concavity).

In the first round Ukko has nothing to lose, so he will always take the first question. After that, no matter how many rounds Ukko would be able to play, he would always prefer to stop earlier and will therefore stop exactly after the first question.

You could also use a brute force approach, that is calculate the certainty equivalent (or expected utility) for every $S = 1, \dots, 12$ using the approach seen for cases $S = 2$ and $S = 12$ above. That would be a lot of calculations by hand, but if you plug the equation for $EU_{S=s}$ into any numerical program (even Excel will do) it is easy to compare the results for all values of S . It is straightforward to confirm that Ukko gets the highest expected utility from a strategy if quitting after the first question. The certainty equivalent is approximately 5.00 euros, so for practical purposes he is almost indifferent between $S = 1$ and $S = 2$. This is because the 50-50 "gamble" between 0 and 20 euros, while clearly unattractive, is very time compared to his baseline wealth so the risk premium is also subsequently tiny.

- (d) Since Akka has a much better than random chance of answering questions correctly, the gamble of continuing is more attractive to her, even though she has the same risk preferences as Ukko. To determine Akka's reservation value, we must first figure out the optimal round for her to stop, S^* and calculate the corresponding expected (Bernoulli) utility. Employing the previous logic, Akka won't stop on the last round given she's got that far. Neither she will stop on the penultimate round et cetera. She'll therefore play all the 12 rounds.

Akka's expected utility from stopping after 12 rounds is

$$EU_{12} = (3/4)^S \sqrt{100000 + 10 \times 2^{12-1}} + (1 - (3/4)^{12}) \sqrt{100000} \approx 317.206.$$

We want to know, what is the maximum amount of money Akka would be willing to lose for certain if she gets to play the gamble. Denote the sum by x and the problem can be stated as

$$\begin{aligned} \sqrt{100000} &= (3/4)^{12} \sqrt{100000 - x + 10 \times 2^{11}} + (1 - (3/4)^{12}) \sqrt{100000 - x} \\ \implies x &\approx 619.33. \end{aligned}$$

As in the case for Ukko, you could also use the brute force approach to show this. (Also in that case a complete answer requires showing what formula you used to do the calculations.)

45. First, recall that for CRRA preferences, the Bernoulli utility, indicating the utility of a risk-free wealth x is

$$u(x) = \frac{x^{1-\rho}}{1-\rho}.$$

Second, recall that the certainty equivalent (CE) is the risk-free payment needed for a consumer to be indifferent between this risk-free option, and a lottery (here the risky investment), and that the relevant notion of utility here is expected utility. This indifference condition will directly allow us to solve for R_i , which is the only unknown for a given individual i . Denoting investment by I we have the condition for individual i :

$$\begin{aligned} \frac{(I(1+R_i))^{1-\rho_i}}{1-\rho_i} &= 0.5 \frac{(0.9I)^{1-\rho_i}}{1-\rho_i} + 0.5 \frac{(1.2I)^{1-\rho_i}}{1-\rho_i} \implies \\ R_i &= [0.5(1.2^{1-\rho_i} + 0.9^{1-\rho_i})]^{\frac{1}{1-\rho_i}}. \end{aligned}$$

The last equality shows that R is independent of wealth level I . Note that while CRRA preferences does not imply that the CE is independent of the investment into the lottery, it does imply the CE as a share of investment remains unchanged. That is, $CE/I = 1+R$, the return on investment required remains unchanged. This is indeed the key property of CRRA preferences.

- (a) We can now use the above observations to solve for R , given $I = 1M$. Here, note that for Bob, we have $\rho_C = 1$, in which case the Bernoulli utility can be expressed as $\ln(x)$, which means that similarly solving for R from the indifference condition gives us

$$R_B = \sqrt{1.2 \times 0.9} - 1 \approx 0.039.$$

For Ann and Cecilia, we use the derived result to calculate R , and we get $R_A \approx 0.045$, and $R_C = 0.05$.

- (b) As we observed in the previous subsection, R is independent of initial wealth in case of CRRA preferences. This means that for $I = 10M$, we have an identical result: $R_A \approx 0.045$, $R_B \approx 0.039$, $R_C = 0.05$.

46. (a) With initial wealth of 12 million euros, the certainty equivalent of placing b million euros on the bet is the value v (in million euros) that solves

$$\begin{aligned} \log(12+v) &= \frac{1}{3} \log(12-b+0) + \frac{2}{3} \log(12-b+2b) && \text{[apply exponential function]} \\ 12+v &= (12-b)^{\frac{1}{3}}(12+b)^{\frac{2}{3}} && \implies \\ v &= (12-b)^{\frac{1}{3}}(12+b)^{\frac{2}{3}} - 12 \end{aligned}$$

Plugging in the possible amounts wagered $\{1, 4, 8\}$ m euros into this formula results on the RHS in Certainty Equivalent of about $\{0.3, 0.7, -0.3\}$ m euros respectively. Hence betting $b = 4$ m euros is the preferable choice for this punter.

(b) Logarithmic utility makes proportional choices scale-invariant.⁷ With wealth now one tenth of the original, optimal bet and its CE are also one tenth of the original. Optimal choice is now 0.4 and its CE is 0.07 (million euros).

(c) The punter's expected utility as a function of her bet b (in millions of euros) is

$$U(b) = \frac{1}{3} \log(12 - b) + \frac{2}{3} \log(12 + b)$$

The first order condition $U'(b) = 0$ is

$$\begin{aligned} -\frac{1}{3(12 - b)} + \frac{2}{3(12 + b)} &= 0 \implies \\ 2 \times 3(12 - b) &= 3(12 + b) \implies \\ b^* &= 4 \end{aligned}$$

Since betting $b = 4$ million maximizes expected utility it must also have the highest certainty equivalent, which we already calculated earlier to be 0.7 million euros. We also know from part 46a that this is a maximum, not a minimum.

Logarithmic utility implies that the punter will invest a fixed fraction of her wealth to the gamble regardless of initial wealth, so knowing that the optimal share is $4/12 = 1/3$ at this level of wealth shows that indeed it would be optimal at any level of wealth.⁸

47. (a) The cost function gives the smallest total cost achievable for consuming a given amount of TPUh.

Observe that the different deals correspond to different cost per unit purchased: 2€ , $50/100=0.5\text{€}$, and $80/200=0.4\text{€}$ for the linear price deal, and packages of 100 and 200 units, respectively. Because unused units are worthless, the consumer may not buy the largest bundles even if they imply a cheaper per unit cost.

Knowing this, we can consider the cheapest possible combinations given a desired level of consumption.

⁷You could just directly invoke this property of log-utility, but this could also be verified by multiplying wealth and bet size above by any positive constant k . The first equation (which is the definition of certainty equivalent) can continue to hold only if v is then also multiplied by the same constant k . The terms involving k factor out and add up to $\log(k)$ on both sides and cancel out.

⁸For investment choices that have just two possible outcomes, logarithmic preferences lead to a particularly simple decision rule that is also known as the Kelly criterion.

For $q \in [0, 25]$, the consumer clearly purchases the linear package at 2€ per unit, after which it purchases the 100 unit package in the range $q \in (25, 100]$ at a cost of 50€. Similarly, in the range $q \in (100, 115]$, the consumer purchases the 100 unit package and $(q - 100)$ units at 2€, so that the total cost is $50 + (q - 100) \times 2$; $50 + (q - 100) \times 2 = 80 \implies q = 15$. Then, in the range $q \in (115, 200]$, the consumer purchases the 200 unit package at a cost of 80€. Note that at 200 units consumed, the reasoning is analogous to when considering consumption levels starting from zero; the consumer uses the linear price package and the 200 unit package up until $q = 225$, after which it adds a 100 unit package.

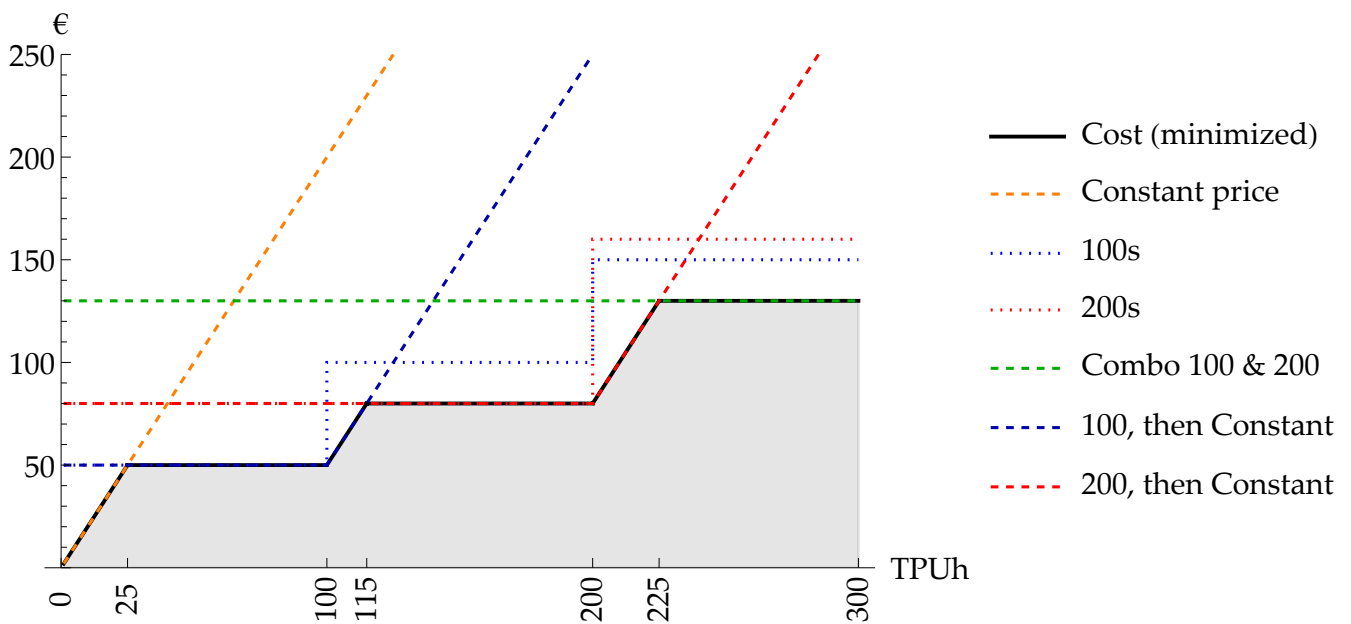

Figure 52: Total cost of various levels of TPUh in problem 47a. The black line shows the lowest-cost alternative at each level of use, which defines the total cost function.

The resulting total cost function is flat at the levels when the consumer purchases only packages of 100 and 200 units, as depicted in figure 52

Additional comment. If one interpreted the exercise such that the consumer cannot purchase the linear price in combination with 100 and 200 unit packages, there would be discrete jumps in the total cost function at $q = 100, 200$.

- (b) The budget set is the combinations of x (equipment) and y (TPUh) that the consumer can afford. Because the price of one unit of x is one, this set be defined by $x \leq 150 - TC_y(y)$, where TC_y is the total cost function derived in part 47a. That is, if the consumer purchases y units of TPUh, it cannot afford more than $150 - TC_y(y)$ units of equipment.

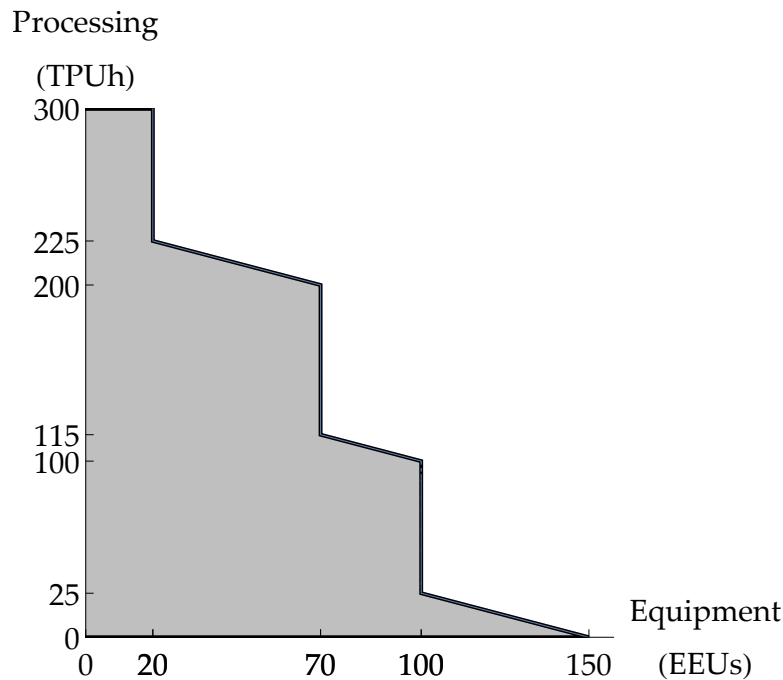

Figure 53: Budget set for cloud services and equipment in part 47b.

The budget set is depicted in Figure 53. Note the similarity between the budget set and the total cost function in Figure 52. The difference is that here all remaining funds of the €150 budget are spent on equipment.

- (c) Observe first that there are kink points on the budget line depicted in Figure 52. This means that the consumer can get more cloud services without forgoing any equipment. Smooth preferences mean that we can imagine a set of smooth indifference curves in the y - x plane. The points of tangency between those indifference and the budget set will tend to be at the kink points of the budget set.

That is, consumers optimal bundles will tend to be at $y = 100, x = 100$; $y = 200, x = 70$; $y = 300, x = 30$, where the consumer purchases only different combinations of 100 and 200 TPUh packages.

48. (a) Denote the quantity of yogurt by y and xylitol by x . The equation for her budget set is setting the money spent on both goods equal to her total budget (240×0.5):

$$6x + 9y = 120$$

$$y = \frac{40}{3} - \frac{2}{3}x$$

With this budget, we are told Alice buys 4 liters of yogurt and 14 boxes of xylitol. The blue line in Figure 54 displays this graphically, along with an indifference curve that is consistent with her choice. Notice that any indifference curve that has a tangent with Alice's consumption choice is consistent.

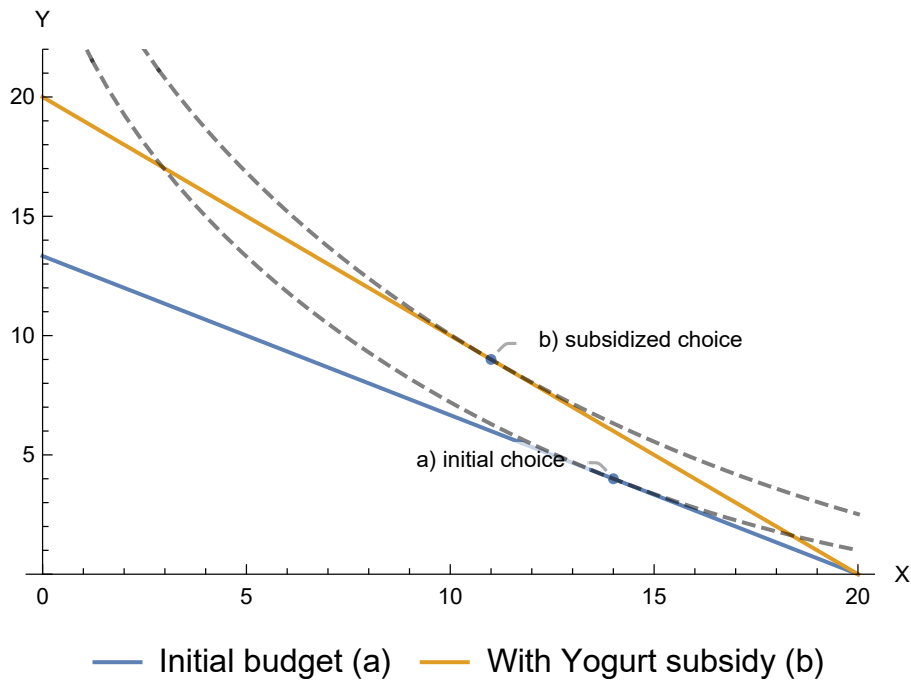

Figure 54: Alice’s consumption space and the impact of a subsidy in 48a, 48b.

- (b) A government subsidy $s = -3$ reduces the price of Yogurt to $9 - 3 = 6$. Alice’s budget after the rebate is taken into account is:

$$6x + 6y = 120$$

$$y = 20 - x$$

The orange line in Figure 54 corresponds to her new budget set after the subsidy. The figure also shows an example of an indifference curve that is consistent with her new consumption choice.

Compensating variation (CV) corresponds to the money that would have to be taken away from Alice for her to drop back to her old utility (before the price change). She achieves her old level of utility by consuming a bundle that is on the same indifference curve as her initial choice $y = 4$ and $x = 14$. The red line in figure 55 is a budget set that achieves precisely this. Notice that the exact position of this hypothetical budget set depends on how you drew your indifference curves. In my example Alice would have to be taxed by $CE = (20 - 17.2) \times 6 = 16.8$ euros to revert back to her old utility levels. In other words, the compensating variation of the rebate policy for Alice is 16.8 euros. This can be thought of as the net utility gain of the rebate for Alice. CV is the maximum Alice would be willing to pay to make the policy happen.

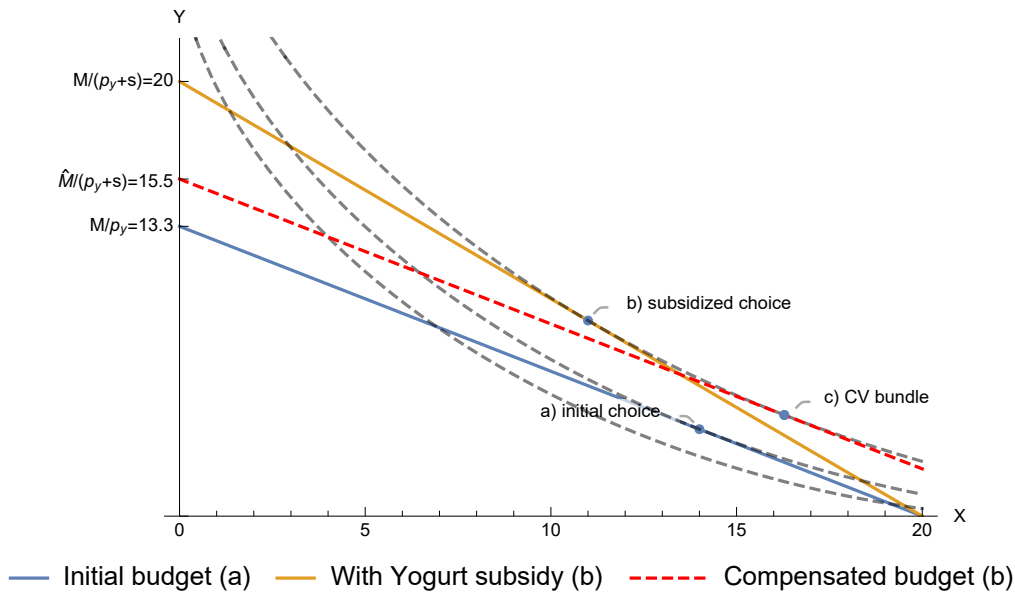

Figure 55: Figuring out Alice’s compensating variation for the yogurt subsidy.

Note that for every liter of yogurt, government is spending 3 on subsidies. Total government spending on Alice after the rebate is then $9 \times 3 = 27 > 16.8 = CE$. The government is spending more than Alice is gaining.

(c) After the "clawback" tax, Alice’s new budget constraint is:

$$6x + 6y = 120 - 27 = 93$$

As shown in Figure 56 this budget set (green line) lies strictly below the original budget set, preventing Alice from achieving her earlier utility levels. The lesson is precisely in this insight: even a budget neutral policy that alters prices through subsidies or taxes can never increase consumer welfare, because in the process, it will invariably distort consumer behavior.

49. (a) Anna’s disposable income is $1200 \times (1 - 0.25) = 900$. Let q_E and q_B be the quantity she purchases electricity and other goods. Denote the price of electricity by p_E . The following baskets use up her budget in full and therefore constitute the budget line:

$$10q_E + 20q_B = 900 \Leftrightarrow q_E = \frac{-20q_B + 900}{10}$$

Plugging in prices $p_E = 10$ and $p_E = 30$ yield $q_E = -2q_B + 90$ and $q_E = -(2/3)q_B + 30$, respectively.

- (b) Anna’s spending of electricity last period was third of her budget, i.e. $10q_E = 900/3 \Leftrightarrow q_E = 30$ and after the price change we have $30q_E = 900/2 \Leftrightarrow q_E = 15$.

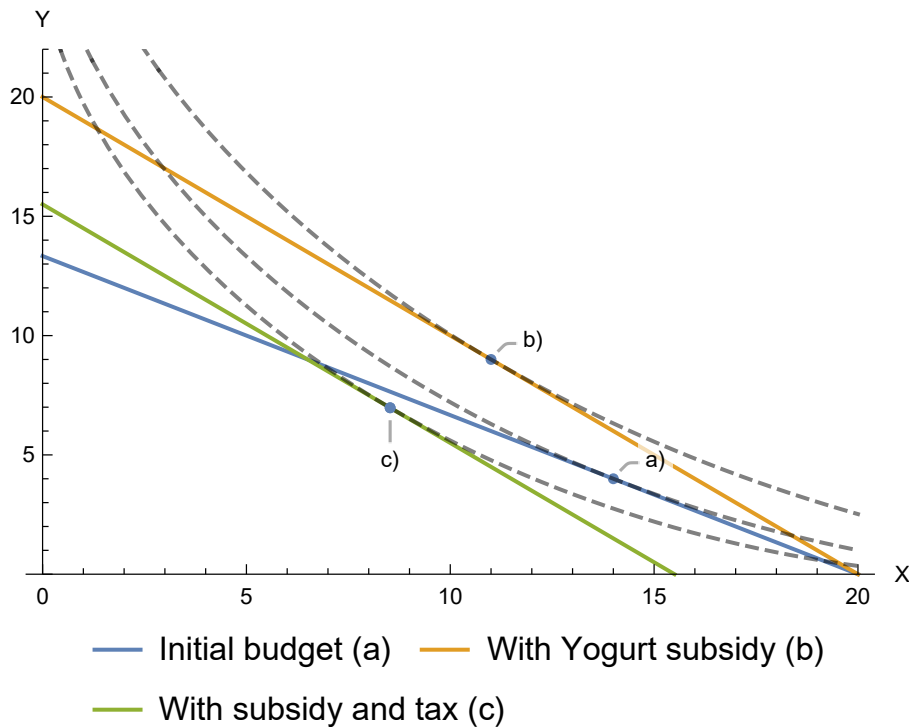

Figure 56: Alice’s final utility level c) after budget neutral policy in part 48c.

(c) Anna spends $900/3 - 900/2 = 150$ euros more on electricity. A change in relative prices affects the slope of the budget line. If Anna gets more money, the budget line shifts upwards but stays parallel to the original as the relative prices remain intact. We add to her budget the amount of money that makes her new, tilted budget line just touch the indifference curve she was before the price change so that the original level of utility is restored. This amount is called the compensating variation (CV).

(d) Government spending is the difference between how much Anna spends on electricity and what it would have cost her at the market price. The government policy doesn’t give Ann more money but it distorts the relative prices, preventing Anna from reaching the utility level she’d have in absence of the policy.

The amount money Anna spends remains unchanged: she gets the same amount back as a subsidy that she got taxed, and the price of the basket of other good remains unchanged. Therefore the new consumption bundle must lie on the budget line she’d have without the policy. Since she was choosing the optimal bundle then and now chooses a different bundle, she’s worse off.

50. (a) The budget set defines the bundles of goods that a consumer can purchase. The budget line defines the bundles the consumer can afford when using the whole budget, that is, $M = p_x x + p_y y \implies B_y(x) = \frac{M}{p_y} - \frac{p_x}{p_y} x$, where M denotes the budget and B_y

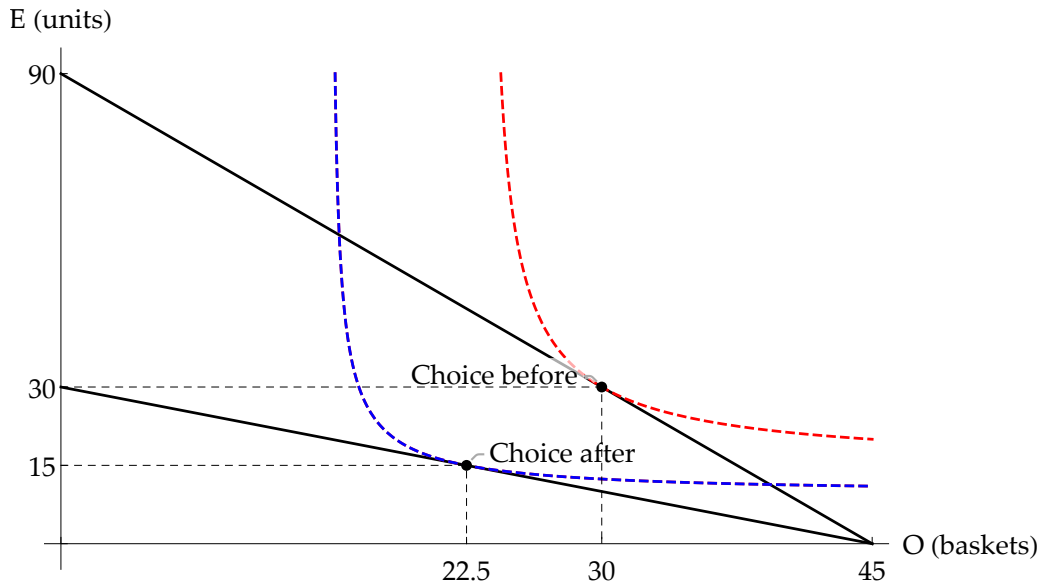

Figure 57: Two indifference curves for Anna that are consistent with her choices in part 49b.

denotes the affordable amount of y as a function of consumption on the other good, x . From this expression, we see that the slope of the budget line is $-\frac{p_x}{p_y}$.

Similarly, the indifference curve pins down the consumption bundles that give the same level of utility. Considering small changes in x and y respectively (denoted Δ_x, Δ_y), the slope of the indifference curve is given by

$$\begin{aligned}\Delta U &= \Delta_x u_x(x, y) + \Delta_y u_y(x, y) = 0 \\ \iff \frac{-\Delta_y}{\Delta_x} &= \frac{-u_x(x, y)}{u_y(x, y)},\end{aligned}$$

where u_x and u_y denote the marginal utilities of x and y respectively.

Now recall that the optimal consumption bundle is at the point of tangency of the indifference curve and the budget line. Given this, we can solve for optimal consumption level:

$$\begin{aligned}\frac{-u_x(x, y)}{u_y(x, y)} &= \frac{-p_x}{p_y} \\ \iff \frac{0.75x^{-0.25}y^{0.25}}{0.25x^{0.75}y^{-0.75}} &= \frac{1}{4} \\ \iff 3x^{-1}y &= 1/4 \\ \iff 3x^{-1}(2.5 - x/4) &= 1/4 \\ \implies x^* &= 7.5,\end{aligned}$$

where we substituted y by using the budget line (B_y). Finally, the budget line gives us $y^* = 2.5 - x^*/4 = 0.625$.

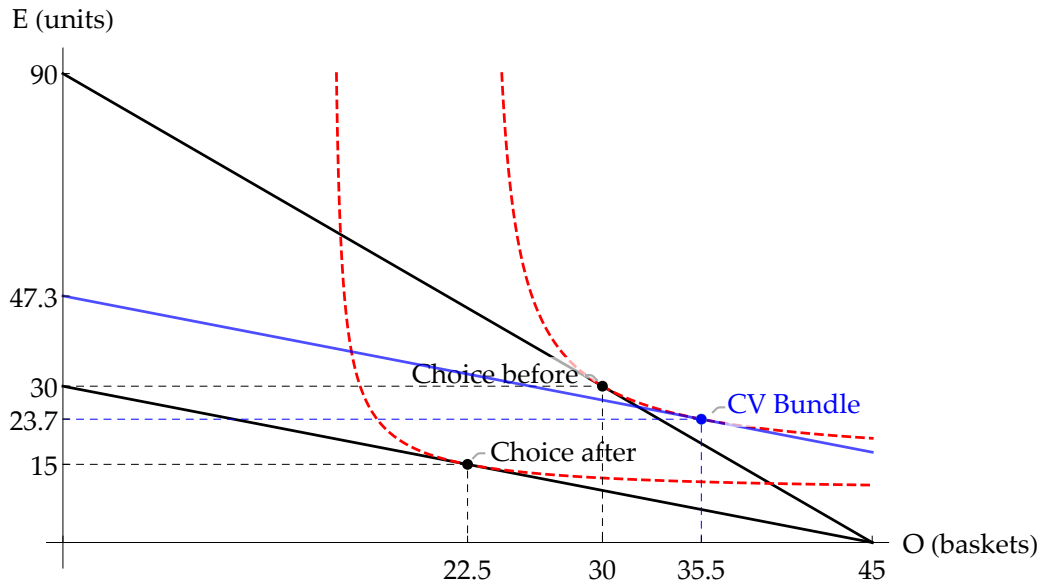

Figure 58: Impact of the price change on Anna’s compensated spending on electricity, see part 49c.

Figure 60 depicts this consumption bundle, as well as a set of indifference curves and the budget line. The budget set is defined by $y \leq 2.5 - x/4$ and it is the area bounded (from above) by the budget line.

- (b) Consider first what the governments budget balance constraint means for consumer spending: the representative consumer must receive as much in subsidy as it pays in taxes for the budget to balance. This means that a consumer who uses its entire budget will not experience a change in total spending.

This means that the consumer’s consumption bundle must still be found on the original budget line. However, the tax-subsidy scheme will alter the relative prices that the consumer faces, so they will make a different choice. But we know that the earlier bundle chosen before the government intervention in part 50a was the one that gives consumer the highest utility among all bundles on the true budget line. Hence this policy must reduce consumer welfare. This is closely related to what economists mean when they talk about “price distortions”.

Additional comments. There was no need to solve for the new consumption bundle, because only the direction of change in consumer welfare was asked for. But here is how to do it. First substitute the left hand side of the government budget balance condition, $sy = x\tau$, into the consumers budget line with new consumer prices, $p'_y = p_y - s$, $p'_x = p_x + \tau$. Now $s = 2$, because that is what brings back the gasoline price to what it was before it was doubled to its current level.

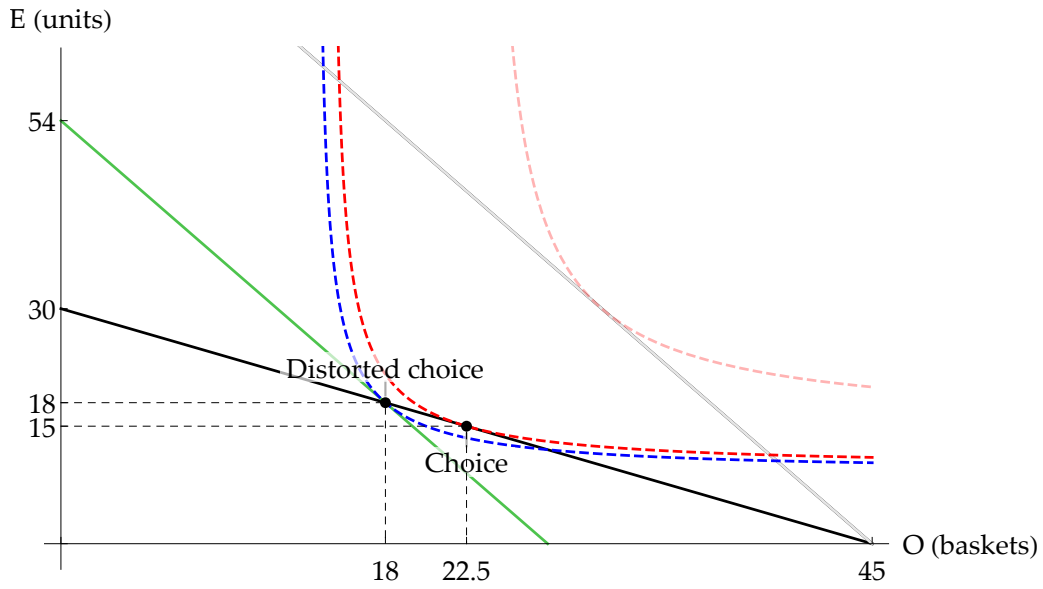

Figure 59: Figuring out the impact of a budget neutral subsidy+tax policy on Anna's welfare, see part 49d.

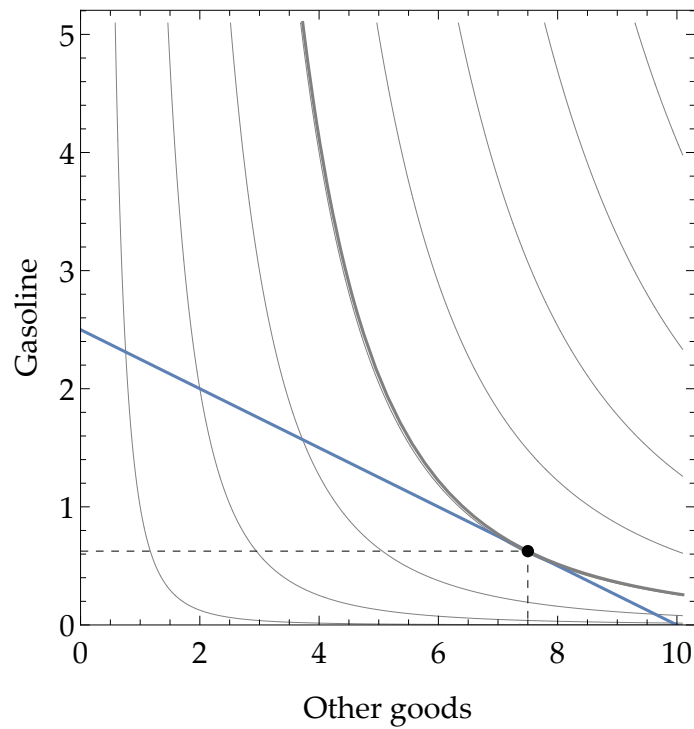

Figure 60: Optimal consumption of gasoline and other goods in part 50a.

Given the new consumer prices, the budget line without the budget balance restriction is

$$B'_y(x) = \frac{10}{p_y - 2} - \frac{x}{p_x + \tau} = 5 - \frac{x(1 + \tau)}{2}.$$

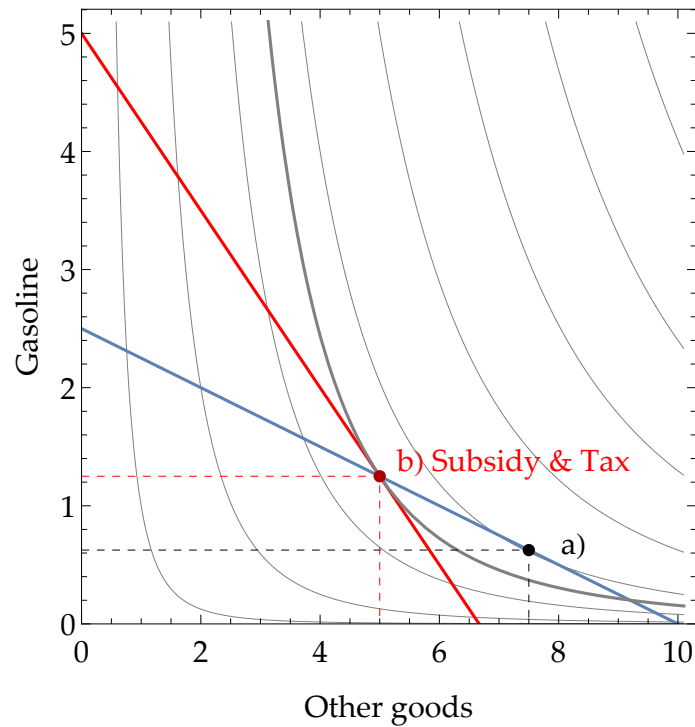

Figure 61: Price distortion and optimal consumption of gasoline and other goods in part 50b.

Substituting this into the tangency condition allows one to solve for $x^{**}(\tau)$, and substituting this into B'_y allows one to find y^{**} . Substituting y^{**} and $x(\tau)$ into the budget restriction of the government, $2y = \tau x$, allows one to find τ , from which one gets x^{**} . This results in $y^{**} = 1.25, x^{**}, \tau = 0.5$.

The new consumption bundle is depicted in Figure 61. Consumers experience a decrease in welfare because the real resources available to them have not changed (the subsidy does not come from outside world) but it distorts the price. The old consumption bundle was their optimal preferred bundle under the true budget set (blue line) defined by the world market prices. The new choice, being different from the optimal, must result in lower utility. The red line in the figure depicts the budget line faced by the consumer that adheres to the government budget balance condition at the consumer's new choice bundle.

51. (a) The consumer can spend at most $M = 100$, the price of apples $p_a = 0.5$ and $p_b = 1$. Then it must be that $0.5a + b = 100 \implies b(a) = 100 - 0.5a$. Plugging this into the utility function we get $u(a, b(a)) = a^{\frac{1}{4}}(100 - 0.5a)^{\frac{3}{4}}$.

Keeping eye on part 51b, we derive the optimality condition for any budget M and price p first. Take the first order condition using product rule and chain rule.

$$\begin{aligned} u'(a, b(a)) = 0 &\iff \\ \frac{1}{4}a^{-\frac{3}{4}}(M - pa)^{\frac{3}{4}} + a^{\frac{1}{4}}\frac{3}{4}(M - pa)^{-\frac{1}{4}}(-p) &= 0 \iff \\ \frac{1}{4}(M - pa)^{\frac{3}{4}}(M - pa)^{\frac{1}{4}} &= \frac{3p}{4}a^{\frac{3}{4}}a^{\frac{1}{4}} \iff \\ M - pa &= 3pa \implies \\ a &= \frac{M}{4p} \end{aligned}$$

Plugging in $M = 100$ and $p = 0.5$ we get $a^* = 50$.

- (b) Derived in part 51a. Demand for apples is $a^d(p, M) = M/(4p)$.
- (c) With total expenditure of M the consumer spends $pa^d(p, M) = M/4$ on apples. Therefore the expenditure share of apples is $1/4$.

This is a general property: with a Cobb-Douglas utility function $u(x_1, x_2, \dots, x_n) = x_1^{\alpha_1} \times x_2^{\alpha_2} \times \dots \times x_n^{\alpha_n}$, where $\alpha_1 + \alpha_2 + \dots + \alpha_n = 1$, the expenditure share on good j is α_j regardless of prices and income.

52. (a) In the 0th year, only BrickPhone is available and average price is 100.
The next year market is shared evenly and average price is $0.5 \times 100 + 0.5 \times 300 = 200$.
Average price in the 2nd year: $0.4 \times 100 + 0.6 \times 300 = 220$.
3rd: $0.3 \times 100 + 0.7 \times 300 = 240$
4th: $0.2 \times 100 + 0.8 \times 300 = 260$
5th: $0.1 \times 100 + 0.9 \times 300 = 280$
6th: $1.0 \times 300 = 300$
- (b) Now we aggregate over phone models, not phones sold.
0th: 100
1st: $(100 + 300)/2 = 200$
2nd through 6th, all 200
(7th: 300 (BrickPhone no longer sold))
- (c) FancyPhone was chosen when also BrickPhone was available. Therefore people must be better off with a consumption bundle which includes FancyPhone. Since they do better with the same budget choosing a FancyPhone rather than a BrickPhone, their real income increases and therefore overall price level is decreased. (There was no information that would allow us to quantify by how much the price level decreased).

53. (a) The firm will produce a quantity at which the marginal cost equals marginal revenue. Because the firm is a price taker (i.e. its output doesn't have effect on the price), marginal revenue simply is the market price of the good, p .

Optimality condition can be written as $2 + 0.2q = p \implies q^s(p) = 5p - 10 = 5(p - 2)$. The firm will not operate at a loss, so we must have that $\pi(p) \geq 0 \implies p \geq 4$, where we used the expression for profits from (b). Otherwise firm will produce zero output.

- (b) To derive the profits we must figure out total costs. Marginal cost is the derivative of variable costs, so variable costs are the integral of the variable costs.

$$VC(q) = \int_0^q (2 + 0.2x)dx = 2q + 0.1q^2$$

To get total costs just add the fixed cost 10. Profits as a function of output price are the difference between revenue and total cost, with the optimal quantity $q^s(p)$ supplied:

$$\begin{aligned} \pi(p) &= \underbrace{pq^s(p)}_{\text{Revenue}} - \underbrace{(2q^s(p) + 0.1q^s(p)^2)}_{\text{Variable cost}} - \underbrace{10}_{\text{FC}} \\ &= (p - 2)q^s(p) - 0.1q^s(p)^2 - 10 \\ &= 5(p - 2)^2 - 0.1(25p^2 - 100p + 100) - 10 \\ &= 2.5p^2 - 10p \end{aligned}$$

when $p \geq 4$, and zero otherwise. Notice that the profit function is continuous, even though supply jumps at the break-even price $p = 4$. This is because the firm must be able to cover its fixed costs to supply any stuff at all. The quantity supplied at the break-even price, $q^s(4) = 10$, is known as the minimum efficient scale of production.

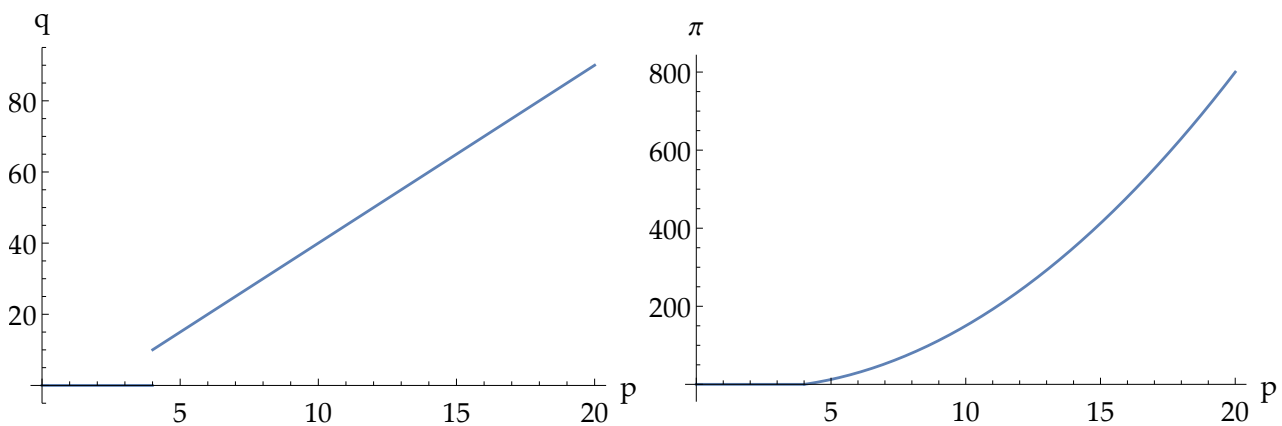

Figure 62: Supply and profit as functions of output price, from parts 53a and 53b respectively.

- (c) As more and more firms enter, the market supply curve will shift upwards: at any given price there will be more supply on the market. With demand decreasing in p we know that such shift will lower the market price. As long as price is high enough for firms to earn positive profits, more firms will enter.

In (a) we already derived the price at which firm makes zero profits. Plugging that into the supply curve yields $q^s(4) = 5 \times 4 - 10 = 10$. This is the quantity each firm will produce in equilibrium. Given the price, this is the optimal level of supply as per (a). Therefore best the firm can do is to get zero profits and no firm will benefit from increasing their quantity supplied, nor will any new firm benefit from entering, nor can any existing firm benefit from exiting.

54. (a) At the cost-minimizing input choice the technical rate of substitution (the slope of the isoquant) is equal to the ratio of prices (the slope of the isocost line).

$$\begin{aligned}\frac{\partial q(x, t)/\partial t}{\partial q(x, t)/\partial x} &= \frac{p_t}{p_x} \\ \frac{3x^{\frac{1}{3}}t^{-\frac{1}{3}}}{2t^{\frac{1}{2}}x^{-\frac{2}{3}}} &= \frac{400}{100} \\ \frac{3x}{2t} &= \frac{400}{100}\end{aligned}$$

Solving x we see that the cost-minimizing input choice must satisfy $x^*(t) = (8/3)t$. The cost-minimizing input combination that yields 120 crates must therefore satisfy

$$\begin{aligned}q(x^*(t), t) &= 120 \\ 6\left(\frac{8}{3}t\right)^{\frac{1}{3}}t^{\frac{1}{2}} &= 120 \implies \\ t^{\frac{5}{6}} &= 20 \times \left(\frac{8}{3}\right)^{-\frac{1}{3}} \implies \\ t^* &= 103^{\frac{2}{5}}10^{\frac{1}{5}} \approx 24.6 \\ x^*(t^*) &= (8/3)t^* \approx 65.6\end{aligned}$$

Whether profits are negative (as they indeed would be) does not matter for this question.

- (b) We're asked to find the profit-maximizing amount of turpentine for each price for a fixed level of output. The price of a crate doesn't matter since 120 crates must be produced regardless. The only choice is the mix of inputs to minimize the costs. The difference to 54a is that, instead of plugging $p_t = 400$, we proceed with an unknown p_t . MRT is still $(3x)/(2t)$, but the price ratio is $p_t/100$. Solving x we see that the cost-minimizing input combination must now satisfy $x^*(t, p_t) = (p_t/150)t$.

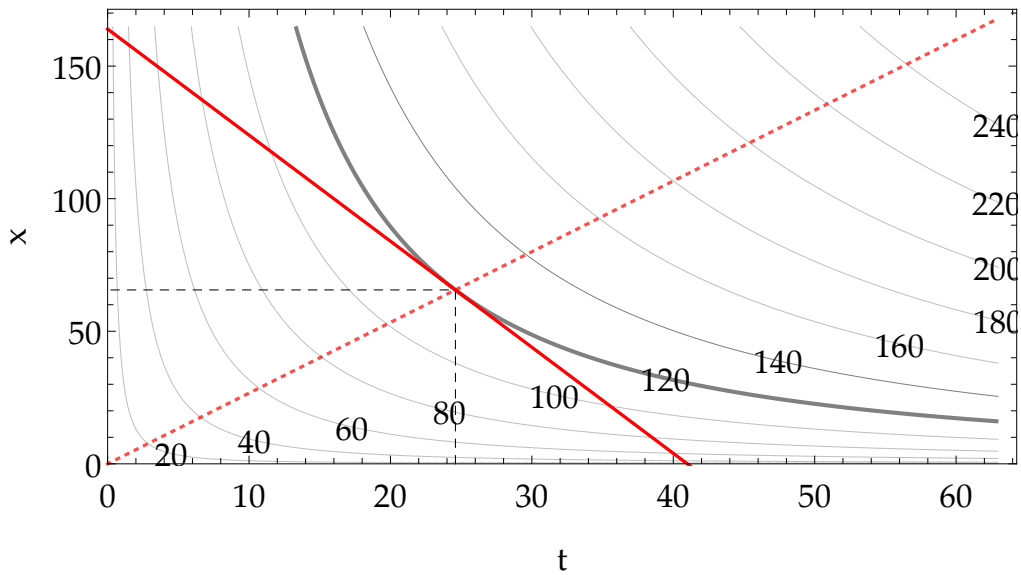

Figure 63: Selected isoquants in gray, and the isoquant for $q(x, t) = 120$ depicted with a thick curve. Lowest isocost line aka budget curve that allows for $q = 120$ in red. Dotted red line shows the cost-minimizing combinations of inputs for all levels of output in the graph (see x^* in part 54a).

The cost-minimizing input combination that yields 120 crates must now satisfy

$$\begin{aligned} q(x^*(t, p_t), t) &= 120 \\ 6\left(\frac{p_t}{150}t\right)^{\frac{1}{3}}t^{\frac{1}{2}} &= 120 \implies \\ t^{\frac{5}{6}} &= 20 \times 150^{\frac{1}{3}}p_t^{-\frac{1}{3}} \implies \\ t^d(p_t) &= 20^{\frac{6}{5}}150^{\frac{2}{5}}p_t^{-\frac{2}{5}} \approx 270.2p_t^{-\frac{2}{5}} \end{aligned}$$

Clark's demand for turpentine has a constant elasticity of demand -0.4 .

- (c) We know from part 54a that cost-minimization requires that $x = x^*(t)$. Now that the level of output is a choice variable this means that one of the inputs can be chosen freely.⁹ Profits are now just a function of one variable:

$$\begin{aligned} \pi(t) &= 100q(x^*(t), t) - p_x x^*(t) - p_t t \\ &= 600\left(\frac{8}{3}t\right)^{\frac{1}{3}}t^{\frac{1}{2}} - 100\frac{8t}{3} - 400t \\ &= 600\left(\frac{8}{3}\right)^{\frac{1}{3}}t^{\frac{5}{6}} - \frac{2000}{3}t \approx 832t^{\frac{5}{6}} - 666.7t. \end{aligned}$$

The FOC is $(5/6) \times 832t^{-\frac{1}{6}} - 666.7 = 0$, from which we find the optimal amount of turpentine at $t^* = 81/64 \approx 1.27$. This leads to optimal amount of $x^* = X(t^*) = 27/8 \approx 3.38$ and output $q(x^*, t^*) = 10.125$.

⁹Equivalently we could choose to determine $t = t^*(x)$ and use x as the choice variable, same results follow.

Lastly we check that profits are indeed positive: $\pi(t^*) = 675/4 \approx 169 > 0$, so this is indeed the profit-maximizing choice.

55. (a) At the cost-minimizing input choice the technical rate of substitution (the slope of the isoquant) is equal to the ratio of prices (the slope of the isocost line).

$$\begin{aligned}\frac{\partial q(x, y)/\partial x}{\partial q(x, y)/\partial y} &= \frac{p_x}{p_y} \\ \frac{10\sqrt{y}}{5x/\sqrt{y}} &= \frac{300}{100} \\ \frac{2y}{x} &= 3.\end{aligned}\tag{1}$$

Solving x we see that the cost-minimizing input choice must satisfy $x^*(y) = 2y/3$.

The cost-minimizing input combination that yields 1000 robots must therefore satisfy

$$\begin{aligned}q(x^*(y), y) &= 1000 \\ 10\frac{2y}{3}\sqrt{y} &= 1000 \\ y^* &= 5 \times 5^{\frac{1}{3}}6^{\frac{2}{3}} \approx 28.2 \\ x^* = x^*(y^*) &= (2/3)y^* \approx 18.8.\end{aligned}$$

- (b) The logic is unchanged from 55a except that we treat p_y now as an unknown:

$$\begin{aligned}\frac{10\sqrt{y}}{5x/\sqrt{y}} &= \frac{300}{p_y} \\ \frac{2y}{x} &= \frac{300}{p_y} \implies \\ x^* &= 2y\frac{p_y}{300}.\end{aligned}$$

As before,

$$\begin{aligned}q(x^*(y), y) &= 1000 \\ 10 \times 2y\frac{p_y}{300}\sqrt{y} &= 1000 \\ y^*(p_y) &= \frac{100 \times 15^{2/3}}{p_y^{2/3}}.\end{aligned}$$

- (c) Notice that $x^*(y) = 2y\frac{p_y}{p_x}$. Energy's share of costs is $\frac{p_y y}{p_y y + p_x x} = \frac{1}{1+2p_y}$ and therefore doesn't depend on the price of tungsten. It remains unchanged.
56. (a) The cost-minimizing combination of the two inputs, high-skill labor h and low-skill labor l , is such that the technical rate of substitution (TRS) equals the ratio of input

prices. In other words, the slope of the isoquant must equal the slope of the isocost. Mathematically, this becomes

$$\begin{aligned} \frac{\frac{\partial f(l,h)}{\partial h}}{\frac{\partial f(l,h)}{\partial l}} &= \frac{w_h}{w_l} \Leftrightarrow \\ \frac{2l^{\frac{1}{2}}\frac{1}{3}h^{-\frac{2}{3}}}{l^{-\frac{1}{2}}h^{\frac{1}{3}}} &= \frac{6}{1} \Leftrightarrow \\ \frac{2l}{3h} &= 6 \implies l^*(h) = 9h. \end{aligned}$$

With these input prices, and this production technology, the cost-minimizing combination will use 9 times as much low-skill labor as high-skill labor. Now we can transform the production function into a function of just one input, by solving h from $q = f(l^*(h), h)$.

$$\begin{aligned} q &= 2(9h)^{\frac{1}{2}}h^{\frac{1}{3}} = 6h^{\frac{5}{6}} \implies \\ h^D(q) &= \left(\frac{1}{6}q\right)^{\frac{6}{5}} \end{aligned}$$

This is the input demand function (while input prices are held constant).

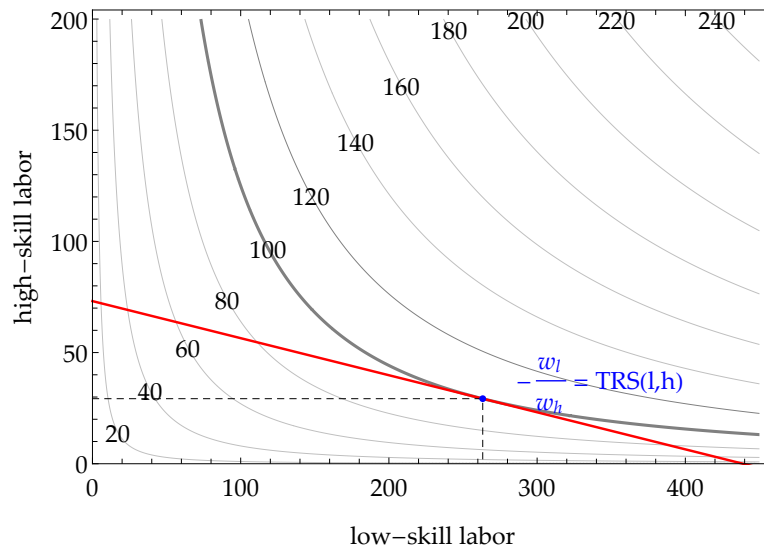

Figure 64: The optimal combination of high- and low-skill labor is found in the point where the slope of the isoquant equals the slope of the isocost line. The isoquant for $q = 100$ and the optimal combination of inputs for producing it for are highlighted, which is the answer to part 56a.

In part 56a, $q = 100$ and so the optimal quantity of high-skill labor is

$$h^D(100) = \left(\frac{100}{6}\right)^{\frac{6}{5}} = 29.2562... \approx 29.$$

We know that $l^D(q) = 9h^D(q)$ so $9 \times 29.2562... = 263.3061... \approx 260$ units of low-skill labor gets used. Hence the cost-minimizing input mix for producing 100 gubbins is $\{l, h\} \approx \{260, 29\}$. This is illustrated in Figure 64.

- (b) Here individual producers are price-takers, so their only decision is how much to produce at the given market price p . This requires choosing a level of output q such that marginal cost equals price. (Price is the marginal revenue for a price-taker.) We already solved for input demands in 56a. This gives us the total cost function as

$$\begin{aligned} \text{TC}(q) &= w_l l^D(q) + w_h h^D(q) + \text{FC} \\ \text{TC}(q) &= 1 \times 9h^D(q) + 6h^D(q) + \text{FC} = 15h^D(q) + 1000 \\ \text{TC}(q) &= \left(\frac{1}{6}\right)^{\frac{6}{5}} q^{\frac{6}{5}} + 1000 \approx 0.1165q^{1.2} + 1000 \end{aligned}$$

Marginal cost is the derivative of the cost function:

$$\text{MC}(q) = \frac{\partial \text{TC}(q)}{\partial q} = \frac{6}{5} \times 15 \left(\frac{1}{6}\right)^{\frac{6}{5}} q^{\frac{1}{5}} = \frac{3}{6^{\frac{1}{5}}} q^{\frac{1}{5}}.$$

Setting $\text{MC}(q)$ equal to price and solving for q gives the profit-maximizing quantity:

$$\begin{aligned} \frac{3}{6^{\frac{1}{5}}} q^{\frac{1}{5}} &= p \Leftrightarrow \\ q^{\frac{1}{5}} &= \frac{6^{\frac{1}{5}}}{3} p \implies \\ q^*(p) &= \frac{2}{81} p^5 \approx 0.0247p^5 \end{aligned}$$

For the supply function we still need to find out whether production is profitable. Supply should be zero if producing $q^*(p)$ would result in negative profits. Profits from producing $q(p)$ would be

$$\pi(p) = pq^*(p) - \text{TC}(q^*(p)) = \frac{2}{81} p^6 - 15h^D(q^*(p)) - 1000$$

We will need to find the threshold level p where this is zero. The zero-profit condition is an equation with just one unknown, and it would be fine to solve it numerically. But we can also solve this analytically. First, let's simplify $\pi(p)$ by evaluating

$$h(p) = h^D(q^*(p)) = \left(\frac{1}{6} \frac{2}{81} p^5\right)^{\frac{6}{5}} = \frac{1}{729} p^6$$

Now the profitability condition becomes

$$\begin{aligned} \pi(p) &= \frac{2}{81} p^6 - \frac{15}{729} p^6 - 1000 \geq 0 \\ \left(\frac{6}{243} - \frac{5}{243}\right) p^6 &\geq 1000 \Leftrightarrow \\ p^6 &\geq 243000 \implies p \geq 7.8995\dots \approx 7.90 \end{aligned}$$

The supply function of an individual producer (illustrated in Figure 65) is therefore

$$q^S(p) = \begin{cases} 0, & p < 7.90 \\ \frac{2}{81} p^5, & p \geq 7.90. \end{cases}$$

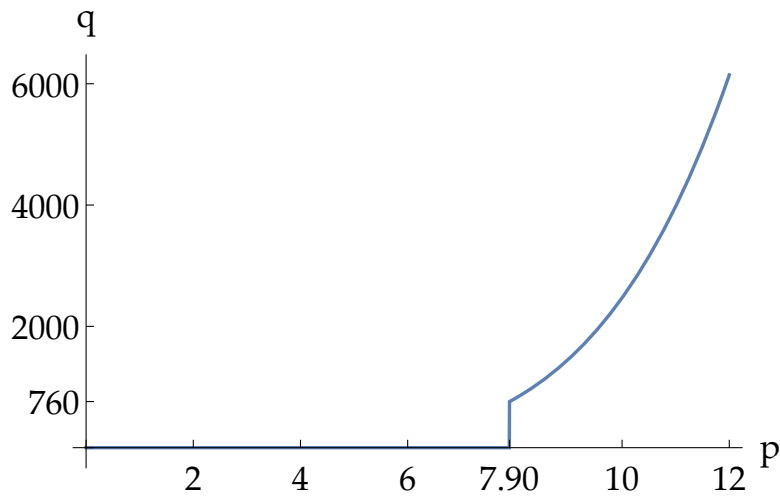

Figure 65: The supply function of an individual firm in part 56b.

Note: Part 56a could be solved as a side effect of first solving the more general problem of part 56b. It is always fine to solve parts in different order, just be clear about this in your solution.

- (c) If profits are positive more firms will enter, increasing total supply and driving down the price. If profits are negative, some will exit. Thus, in a market with free entry and exit, and where all firms have the same cost function, profits must go to zero. We saw in part 56b that profits are zero when the price of gubbins is $p \approx 7.90$ k\$.

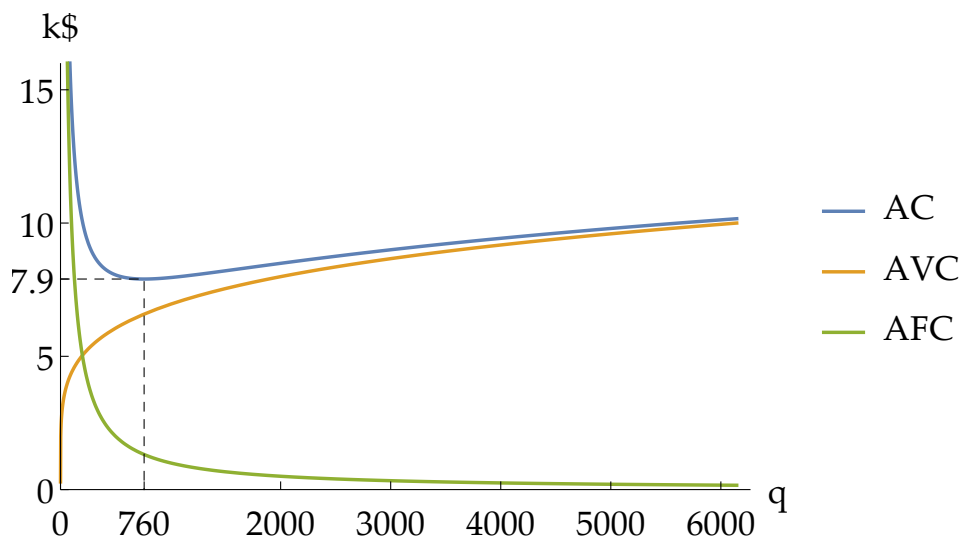

Figure 66: Average costs as a function of output in part 56c.

- 57. (a) Denote the share of hours allocated to health care by h . Consequently, $1 - h$ can be allocated to other goods implying that $y(h) = 1 - h \implies h = 1 - y$. Plugging this into

the production of health care we get the level of life expectancy $x = 20 + 100\sqrt{1 - y}$ as a function of other goods produced. (You can equivalently do this the other way around, this just flips the axes in the figure.) This curve depicts all the combinations that use the whole budget. Any point below this curve would be inefficient, as it would be possible to increase the consumption of health care without reducing the consumption of other goods (and vice versa). Notice that $x = 20$ is achieved “for free”.

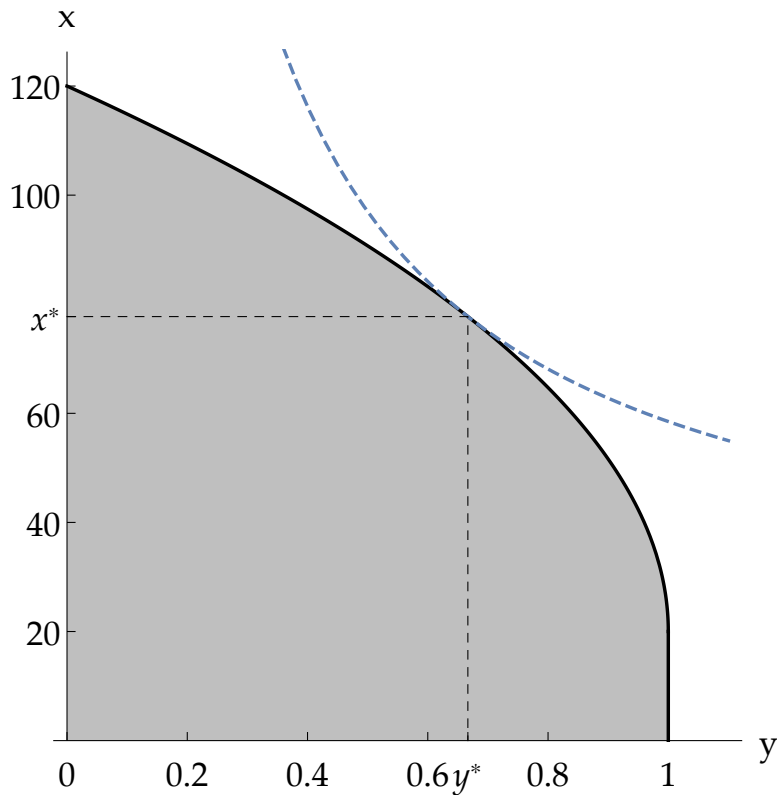

Figure 67: Lilliputians’ production possibilities, the highest indifference curve they can reach, and their optimal choice $\{y^*, x^*\}$.

- (b) In social optimum Lilliputians’ aggregate utility is maximized. As the citizens have a common utility function, this problem coincides with optimizing any individual Lilliputian’s utility. We know that the optimum must lie at some point on the production frontier as there’s no reward from leaving part of the budget unused.

On this frontier, $x = 20 + 100\sqrt{1-y}$. Plugging this into the utility function yields $U(y) = (100\sqrt{1-y})^{\frac{1}{2}}y^{\frac{1}{2}}$. The first order condition $U'(y) = 0$ yields¹⁰

$$\begin{aligned} 10\left(\frac{1}{2}y^{-\frac{1}{2}}(1-y)^{\frac{1}{4}} - y^{\frac{1}{2}} \times \frac{1}{4}(1-y)^{-\frac{3}{4}}\right) &= 0 \iff \\ \frac{1}{2}y^{-\frac{1}{2}}(1-y)^{\frac{1}{4}} &= y^{\frac{1}{2}} \times \frac{1}{4}(1-y)^{-\frac{3}{4}} \iff \times y^{\frac{1}{2}} \\ \frac{1}{2}(1-y)^{\frac{1}{4}} &= \frac{1}{4}y(1-y)^{-\frac{3}{4}} \iff \times 4(1-y)^{\frac{3}{4}} \\ 2(1-y) &= y \implies \\ y^* &= 2/3 \end{aligned}$$

As we have a linear production function for y , producing $y^* = 2/3$ requires $2/3$ million worker years of labor. Life expectancy at the optimum is the obtained by plugging the remaining hours $h = 1 - y^* = 1/3$ into $X(h)$: $x^* = X(y^*) = 20 + 100\sqrt{1/3} \approx 78$ years.

¹⁰Probably an easier way to achieve this would be to note that any value that maximizes a positive-valued function also maximizes its fourth power and that a constant multiplier ($\sqrt{100}$) doesn't affect the optimum anyhow. Our problem would stand as $\max_y y^2(1-y)$ which is simpler to analyze.

5 Decision analysis

58. (a) Before drawing the decision tree, let's shave off redundant branches.

- One-day ticket at 8€ is clearly worse than two single tickets at 6€ on the first day.
- A one day ticket at 8€ is clearly better than a two-day ticket at 12€ on the second day.
- If you bought a 2-day ticket on the first day, you don't need another ticket.

Furthermore, once you have a serial ticket on day two, you take all the trips that give you a positive gross benefit. On the second day, the benefit one gets from holding a one or two-day ticket is $5 + 4 + 3 + 2 + 1 = 15$, 10 or 6 when experience was *good*, *ok* and *bad*, respectively. When buying single tickets, the net benefits are $(5 - 3) + (4 - 3) = 3$, $(4 - 3) = 1$ and 0 for the respective experiences.

Note that in the payoffs in the end of the branches, the first day ticket price enters each node as a sunk cost: whatever the tourist does, she's already paid that and therefore yesterday's price doesn't affect the decision.

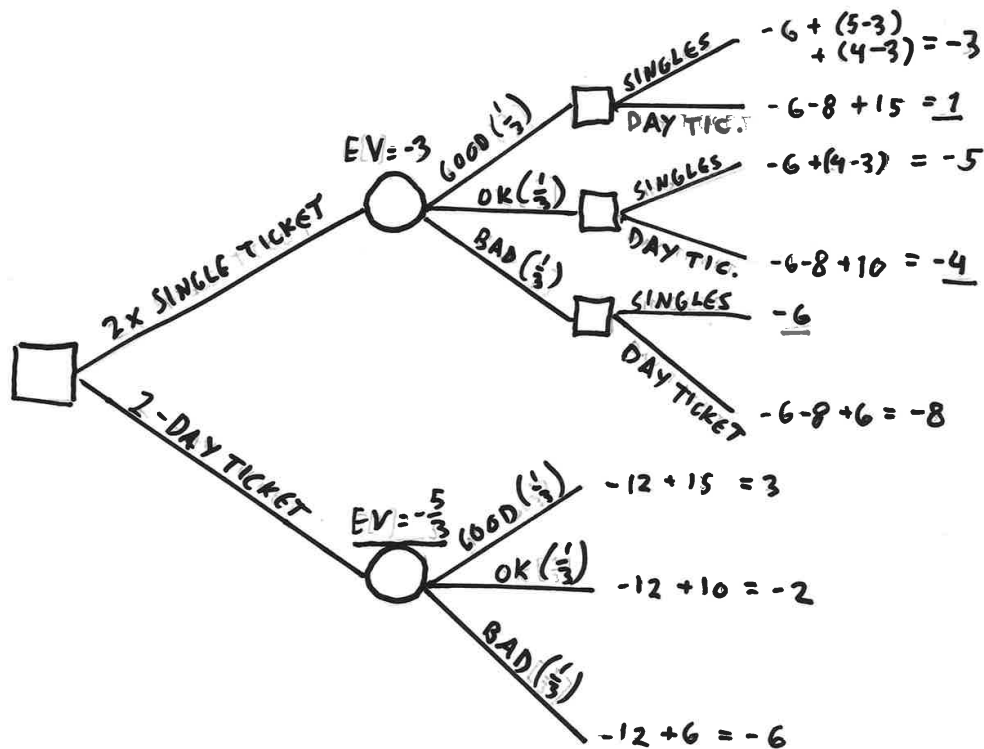

Figure 68: Decision tree for the ticket purchase problem in Problem 58.

- (b) The tourist will buy a two-day ticket on day one as $-5/3 > -3$. On day two, she'll take all the trips that give her positive net benefit. The optimal actions are highlighted in the decision tree (Figure 68).
- (c) If the tourist knew that the experience would be bad, she'd be indifferent between the two relevant ticket options on the first day. Both would give a payoff of -6 under the optimal course of actions as seen from the graph. For the other two experiences, it would still be optimal to take the two-day ticket as $-2 > -4$ and $3 > 1$.

The tourist would take the same decision on day one whether or not she knows the experience. On the second day, there's no more uncertainty anyway so reading won't affect day two decisions. As the decisions would be the same regardless, reading won't provide any valuable information and the tourist will put zero effort in it.

59. (a) Here, we simply compare the expected values for the two options. Denoting C for Cumin, and F for Fava beans, we have

$$E(\pi^C) = 0.5 \times 300 + 0.5 \times 100 = 200,$$

$$E(\pi^F) = 180.$$

So 200k is the highest expected value that can be achieved.

- (b) Here, sensitivity refers to possible values that $p \in [0, 1]$ can take, that do not change the optimal decision found above. Since expected profits is what matters for the decision, we can simply solve for p as follows:

$$E(\pi^C) \geq E(\pi^F) \leftrightarrow (1 - p)300 + p100 \geq 180$$

$$\leftrightarrow p \leq 0.6.$$

That is, the optimal decision remains unchanged for any $p \in [0, 0.6]$.

- (c) Here we should compare the expected profits for the different decisions, which can be considered as sequences of actions. The decision tree for this exercise is illustrated in Figure 69.

Consider first the option of waiting to find out whether $p = 0.2$ or $p = 0.8$. As the expected value of investing in cumin now should be independent of the possibility of waiting, we know either event $p = 0.2$ or $p = 0.8$ happens with probability 0.5. Now consider the event that after waiting, the agent learns that $p = 0.2$. The expected profits of investing in cumin is then $0.9(0.2 \times 300 + 0.8 \times 100) = 126$. Since the agent gets $0.9 \times 180 = 162$ from then investing in Fava beans, since $162 > 126$, the payoff after learning $p = 0.2$ is 162. Now consider the case where the agent learns that $p = 0.8$. Analogous calculations gives an expected profit of $0.9 \times (0.8 \times 300 + 0.2 \times 100) = 234$ for investing in cumin, and this is higher than 162, the profit from Fava beans.

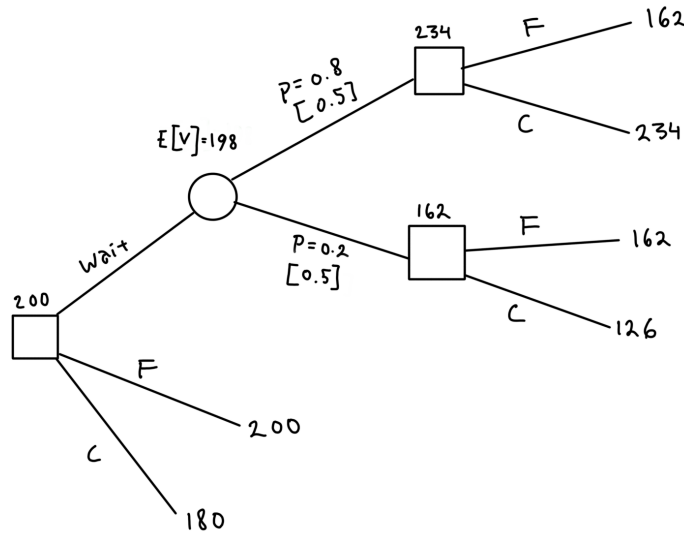

Figure 69: Decision tree of old MacDonald in Problem 59.

Given these observations, we can determine the optimal initial decision. In expectation, waiting give profits of $0.5 \times 234 + 0.5 \times 162 = 198$. The remaining decisions are to invest now in Cumin, yielding the original $0.5 \times 300 + 0.5 \times 100 = 200$, and investing in Fava beans, which gives 180. So we conclude that it is optimal to invest immediately in Cumin.

- (d) We found that when risk neutral, it was optimal to invest in Cumin immediately. We will now consider how a gradual increase in risk aversion affects the optimal decision, which should be considered as a sequence of actions (in the case of waiting, in particular).

First, observe that the agent will never invest in Cumin after bad news ($p = 0.2$), since this is both riskier and gives a lower expected payoff than investing in Fava beans. Hence, action after bad news remains the same regardless of the level of risk aversion. This means we can reduce the set of conceivable sequences of actions to the following set with corresponding expected profits, where we treat them as lotteries for conciseness:

$$\begin{aligned}
 L^C &= (\{0.5, 0.5\}, \{300, 100\}), E(L^C) = 200 \\
 L^F &= (\{1\}, \{180\}), E(L^F) = 180 \\
 L^{W,C} &= (\{0.5, 0.4, 0.1\}, \{162, 270, 90\}), E(L^{W,C}) = 198 \\
 L^{W,F} &= (\{0.5, 0.5\}, \{162, 162\}), E(L^{W,F}) = 162.
 \end{aligned}$$

Here L^C and L^F denote the lotteries of directly investing in Cumin and Fava beans, respectively. Similarly, $L^{W,C}$ and $L^{W,F}$ denote the lotteries of first waiting, and after good news investing in Cumin and Fava beans, respectively.

Now observe that the expected payoff for $L^{W,C}$ is only slightly lower than the risk neutral optimum L^C , and that the variability of outcomes is relatively small. This means that as risk aversion increases, the farmer will first switch his decision to waiting, after which he invests in Cumin after good news (and trivially in Fava beans after bad news). If risk aversion still increases, at some point the farmer will switch to L^F , meaning the optimal decision will never be to wait and invest in Cumin after bad news. This is the case because this lottery has a certain payoff of 162, which is worse than 180.

To conclude, as risk aversion increases, Old MacDonald first switches to waiting and investing in Cumin after good news and Fava beans after bad news. As risk aversion still increases, the MacDonald eventually chooses to invest in Fava beans immediately.

60. (a) The company has the following decisions at hand: (i) whether to develop blueprints, (ii) which quality or qualities of prototypes to produce (iii) whether to build a plant and (iv) how many robots to supply.

To shave off a couple of branches from our decision tree, observe that in case of failed certification no units will be sold or supplied and neither will the plant be built. Non-friendly robots can only be sold at a price below marginal costs which makes them completely irrelevant.

If the company develop a blueprint, it won't sell any robots without certification, which cannot be obtained without a prototype which therefore will always be built along with a blueprint. Therefore (i-ii) are partially hand in hand.

The tree has been simplified to take into account that, once the prototype passes the certification, the company will always build the plant. At that point the development and prototype costs have already been sunk and (as we will soon see) it's possible to sell human-friendly robots at a profit. Basically stages (iii-iv) are incorporated in the payoff realizing in the end of each branch

In (iv), past actions (i-iii) will be sunk costs and the company will choose optimal quantity and price irrespective of those. The company is our usual monopoly and will set marginal revenue equal to marginal cost. Inverse demand is $p^D(q) = 50 - q/2000$, and marginal revenue $MR(q) = \frac{\partial}{\partial q}qp^D(q) = 50 - q/1000$. $MC(q) = MR(q) \iff 50 - q/1000 = 25 \implies q^* = 25000$. Therefore capacity constraint does not bind. Optimal price is $p^* = p^D(q^*) = 37.5$ and profits before any fixed costs $\pi^* = 25000(37.5 - 25) = 312500$.

At stage (iii) plant building costs are not yet sunk, and as $200000 < 312500$, the plant will be built if certification is passed as argued before. Therefore at (ii) the company will know that a successful (failed) prototype will give a profit of 112500 (0) before sunk costs so far, that is, the costs of developing the blueprint.

The firm has two shots: it can either start with building a cheap and more risky low quality prototype, or vice versa. If developing a high quality one first and failing, the company knows that low quality one will fail as well.

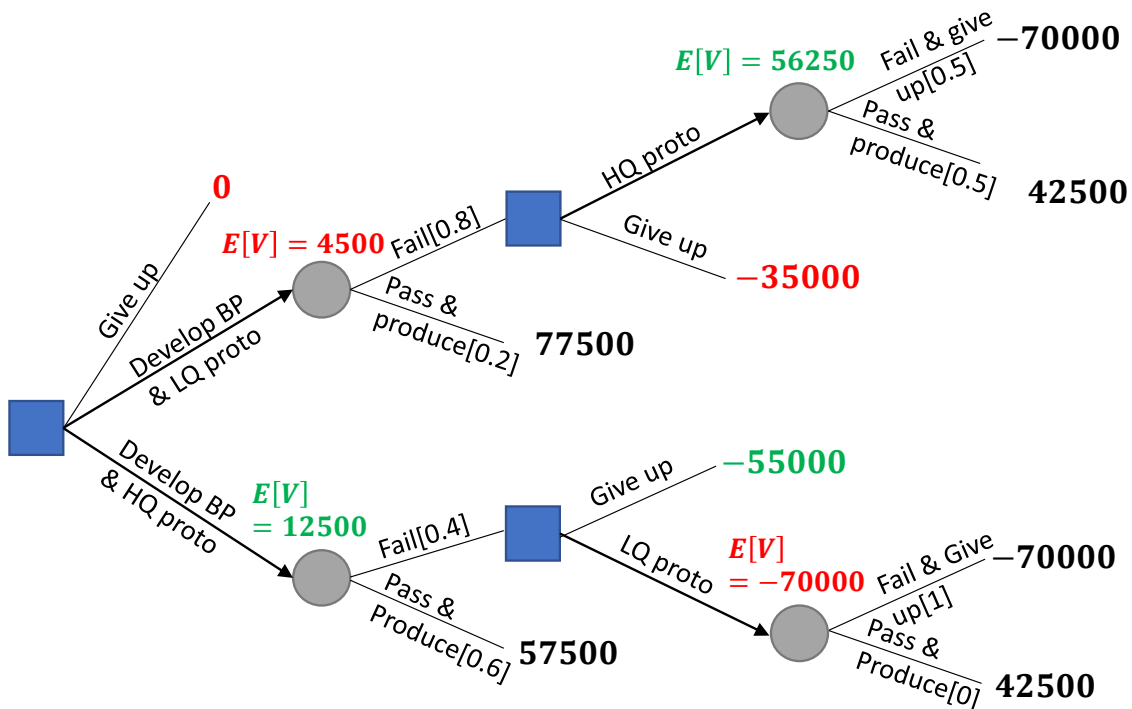

Figure 70: Decision tree for Sirius Cybernetics in 60a.

Assume firm begins with a low quality one. With probability 0.2 it succeeds. If it doesn't succeed, the probability that high quality prototype succeeds is 0.5. To see this, assume there are 100 possible states of the world. In every state where low quality prototype succeeds also high quality prototype succeeds. If low quality prototype fails, we can exclude those 20 successful states in each of which also high quality prototype succeeds. The remaining 80 states have 40 successful and 40 failed high quality prototypes.

The expected profits (before sunk costs thus far) are $0.2(-15000+112500)+(1-0.2) \times 0.5(-15000+35000)+112500+(1-0.2)(1-0.5)(-15000-35000) = 24500$. That is, with probability 0.2 firms succeeds on first try, with complementary probability

it has to retry, which succeeds with probability 0.5. If neither prototype succeeds, firm just has to pay costs.

Starting with a high quality one gives $0.6(-35000 + 112500) + (1 - 0.6)(-35000) = 32500$. If high quality fails, it's not worth experimenting with a low quality one as it will fail. Trying out only low quality option would yield expected profits of 7500, through similar arithmetic.

Therefore the company would optimally try its luck with the high quality prototype. Blueprints cost 20000 and the company can expect profits of 32500 if it takes optimal actions in (ii-iv). The optimal decision is to develop the blueprints in (i), as it generates expected profit of $E[\pi^*] = 12500$.

Note that we could've extended the decision tree in Figure 70 by adding nodes (iii) and (iv) after failed and passed certifications. Because the optimal actions beyond (ii) are quite trivial and basic monopoly optimization, these branches were omitted despite being parts of the decision.

- (b) Assume that firm would see the outcomes by itself without consulting. At the first stage, the company would speculate which certification outcomes it'd see on the second stage. There would be a probability of 0.2 to get away with just a low quality prototype, probability of $0.6 - 0.2 = 0.4$ of getting the certification with high quality prototype (as the firm won't develop a high quality one if low type would be successful) and probability of $1 - 0.2 - 0.4 = 0.4$ not getting the certification at all. Expected profits from making the blueprint would be $-20000 + 0.2 \times (112500 - 15000) + 0.4 \times (112500 - 35000) + 0.4 \times 0 = 30500$. Company would make 12500 profits following the optimal path in the absence of the consulting service. Therefore the reservation price for the services would be $30500 - 12500 = 18000$.
- (c) Adjusting the number of buyers will affect the optimal solution in (iv) and potentially send trembles backwards. Inverse demand becomes $p^D(q, N) = 50 - q/2N$, marginal revenue $MR(q, N) = 50q + q/N$ and optimality condition $50q - q/N = 25 \implies q^* = 25N \implies p^* = 50 - 25/2 = 37.5$.

Profits before sunk costs at stage (iv) become $25N(37.5 - 25) = 312.5N$. Counting in stage (iii) costs we have $112.5N$. Remember that node (iii) was never going to be decisive.

On the second stage we'll have expected profits before sunk costs $0.2(-15000 + N \times 112.5) + (1 - 0.2) \times 0.5(-(15000 + 35000) + 112.5N) + (1 - 0.2)(1 - 0.5)(-15000 - 35000) = 67.5N - 43000$ if starting with a low type one, $0.6(-35000 + 112.5N) + (1 - 0.6)(-35000) = 67.5N - 35000$ if checking high quality prototype first. It's thus always profitable to start with a high quality one if it's worth experimenting or developing the blueprints at all. The break-even point for developing blueprints is $67.5N - 35000 - 20000 = 0 \iff N = 22000/27 \approx 814.2$. If N is above the break-even

point then the firm will develop the blueprints and follow the same optimal path as in (a), Otherwise, it will opt out from the whole thing.

- (d) If successes of different types of prototypes are independent, the problem simplifies somewhat. Failing the first prototype doesn't provide any information about the second and we can simply multiply the probabilities. Our decision tree will be identical expect the probabilities in the rightmost branches. This difference stems from the fact that failed prototype on the first try doesn't provide any information about success of the next one.

Starting with a high quality prototype yields expected profits (before sunk costs thus far) of $0.6(-35000 + 112500) + (1 - 0.6) \times 0.2(-15000 + 35000) + 112500 + (1 - 0.2)(1 - 0.6)(-15000 - 35000) = 35500$.

Analogously, starting with low quality prototype yields $0.2(-15000 + 112500) + (1 - 0.2) \times 0.6(-15000 + 35000) + 112500 + (1 - 0.2)(1 - 0.6)(-15000 - 35000) = 33500$. Again, firm doesn't have to try out both, and trying out only high (low) quality option would again yield expected profits of 32500 (7500). Therefore the firm will optimally try high quality first and proceed to low quality one in case of failure. Given this strategy gives an expected profit greater than the cost of developing the blueprints, blueprints will be developed.

Note that the order of trying out the two prototypes is by no means obvious, because there is a trade-off between quality and price. One test has a higher probability of success, and the other test is cheaper. If one alternative were better in both dimensions it would be obviously the first one to try.

61. (a) The firm has two (non-trivial) decisions to make in respective order: whether to (i) *develop the notion into a concept* and whether to (ii) *turn the concept into idea*. In order to make the optimal decision in (i), one must know the optimal actions in (ii) in different states of the world, i.e. in case of a brilliant, good and a bad concept.

Note that we don't have to draw all the 2 (different states) $\times 3$ (ideas) $\times 3$ (concepts) = 18 possible outcomes or for the last random node. As a brilliant concept always turns into a high-quality idea, only the state of the economy matters there. Noticing that no quality ideas always yield zero regardless of the state of the economy lets us shave off a couple of branches as well.

Brilliant concept yields on expectation $(1/3) \times 48/2 + (2/3) \times 24/2 - 1.5 - 2/2 = 13.5$ if turned into an idea. Selling prices are halved as investors take their share. The last two terms are the development costs born by the company. A good concept yields $(1/3) \times (2/3) \times 18/2 + (2/3) \times (2/3) \times 9/2 - 1.5 - 1 = 1.5$ and a bad concept $(1/3) \times (1/4) \times 48/2 + (2/3) \times (1/4) \times 24/2 - 1.5 - 1 = 1.5$. At this point, giving

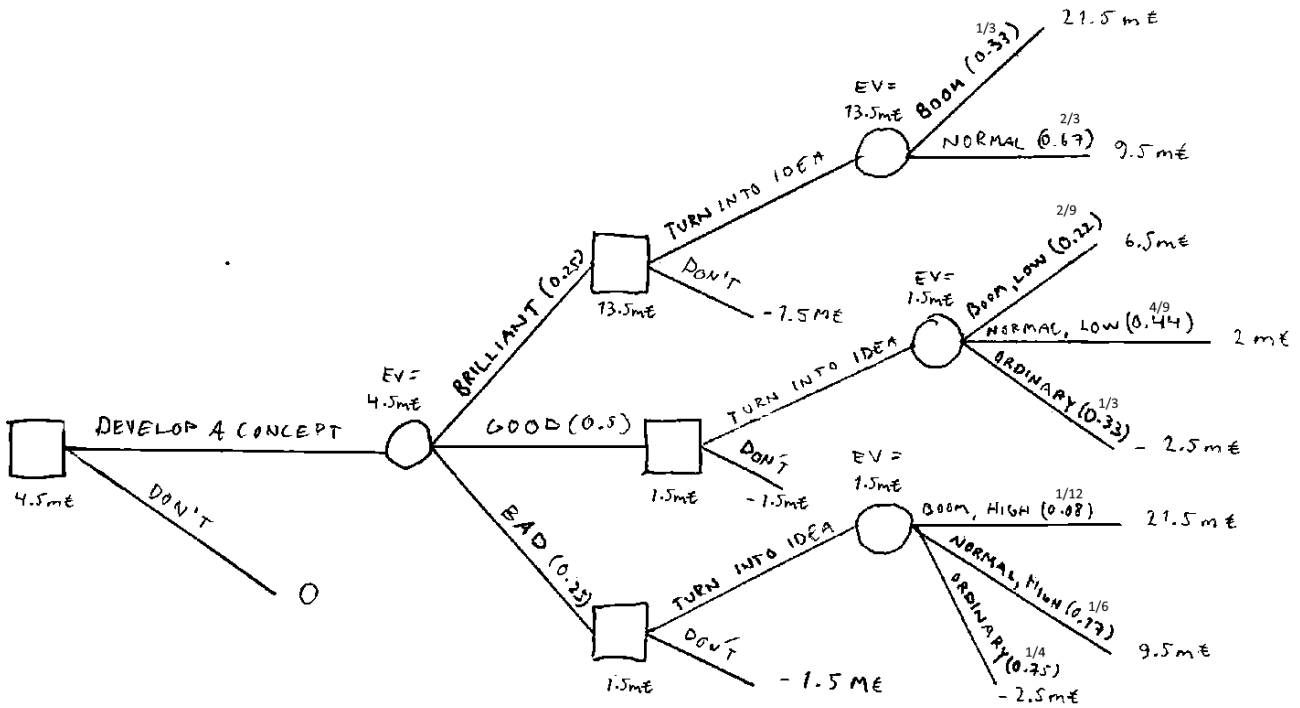

Figure 71: Decision tree for Puupäät Oy in 61a.

up yields -1.5 (the cost of developing the concept), and therefore the concept will be turned into an idea regardless of its quality.

Developing a concept yields a $(1/4)(16 - 1.5 - 1) + (1/2)(4 - 1.5 - 1) + (1/4)(4 - 1.5 - 1) = 4.5$ on expectation. That is, the probability of ending up in each of the subsequent decision nodes is multiplied by the payoff when acting optimally in that node. The company will develop a concept from the notion since the alternative gives zero payoff.

- (b) Denote the share promised to investors by $1 - x$. Brilliant concept now yields a revenue of $16 \times 2 \times x = 32x$ (we first obtain the expected selling price by multiplying by 2 after which the company's share is obtained by multiplying by x), good and a bad concept both $8x$ on expectation.

If the company's expected payoff from a good or a bad concept exceeds the payoff from abandoning the concept, $8x - 1.5 - 1 \geq -1.5 \iff x \geq 1/8$, it's still optimal to turn bad and good concepts into ideas. We proceed with this assumption and check later whether our solution satisfies the condition. The expected payoff from developing a concept is $(1/4)(32x - 1.5 - 1) + (1/2)(8x - 1.5 - 1) + (1/4)(8x - 1.5 - 1) = 14x - 2.5$, which exceeds zero if $14x - 2.5 > 0 \iff x > 5/28 \approx 0.18 > 1/8$. If the production company is promised 82% of the revenue or more, the company will not develop a concept.

- (c) The firm would benefit from the forecast only if knowing the state would let the firm to avoid losses in the case of normal economy: since development was profitable in the previous subsection, it would certainly be profitable if the firm knew that there's going to be a boom and the decision wouldn't change.

Let's check whether developing the concept would be unprofitable if the economy was known to be normal. In case of a brilliant concept, expected revenue would be $24/2 = 12$. Bad and good concept would both yield 3. It would still be profitable to turn any concept into an idea since revenues exceed the costs, $12 > 3 > 1.5 + 1 = 2.5$. Therefore, a concept gives an expected payoff of $(1/4)(12 - 1.5 - 1) + (1/2)(3 - 1.5 - 1) + (1/4)(3 - 1.5 - 1) = 17/4 = 2.75 > 0$ and development therefore will take place. The firm would do the same decisions regardless of the forecast. Therefore it values the forecast at zero.

62. (a) The firm has to decide whether to begin a process of developing a new drug or not. The process includes uncertainties.

Evaluation of the profit maximizing decision requires knowledge about the expected outcomes. In practice, this means identifying six relevant numbers: expected profits for $s \in \{1, 2\}$ and cumulative costs for all four stages.

Expected profits depend on selling price, which is determined by demand. The patent allows the firm to work in a monopoly situation and the profit maximizing price can be solved from setting marginal revenue equal to marginal costs.

Inverse demand is:

$$Q^D(p) = 400s - 5p \Leftrightarrow P^D(q) = 80s - \frac{1}{5}q$$

Marginal revenue:

$$\begin{aligned} \text{MR} &= \frac{d}{dq}(P^D(q)q) \\ &= \frac{d}{dq}\left(80sq - \frac{1}{5}q^2\right) \\ &= 80s - \frac{2}{5}q \end{aligned}$$

Marginal cost is a constant 20.

When $s = 1$:

$$\begin{aligned} 80 - \frac{2}{5}q &= 20 \Leftrightarrow \\ 60 &= \frac{2}{5}q \implies \\ q_1^* &= 150 \implies p_1^* = 50 \end{aligned}$$

And similarly, when $s = 2$:

$$\begin{aligned}160 - \frac{2}{5}q &= 20 \Leftrightarrow \\140 &= \frac{2}{5}q \implies \\q_2^* &= 350 \implies p_2^* = 90\end{aligned}$$

From this follows that profits are $\pi_1 = p_1^*q_1^* - 20q_1^* = 4500$ and $\pi_2 = p_2^*q_2^* - 20q_2^* = 24500$. If $s = 0$ the drug will not be produced so $\pi_0 = 0$. There is some subjectivity in which decisions are left out of the tree as obvious, here we chose to leave out the final decision of whether to produce the drug after phase 3.

Costs are given in the exercise, such that the accumulated fixed costs of developing the new product are $c_1 = 1$, $c_2 = 1.25$, $c_3 = c_4 = 0.5$.

Outcomes are calculated using these numbers, such that the expected outcome is profit minus the fixed costs. These can be seen in figure 72. Note that prices is in billions of euros in the figures and in part 62b and 62c.

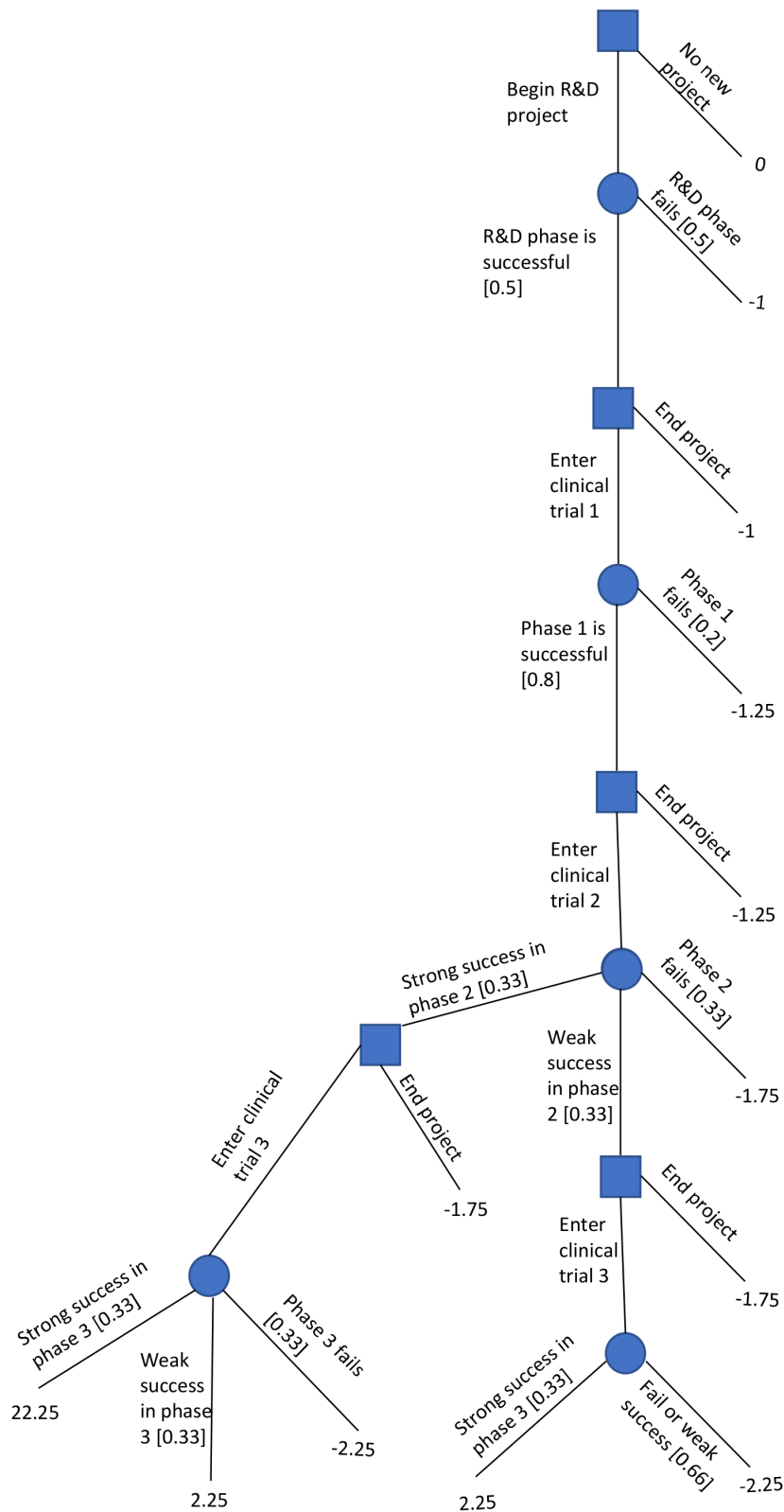

Figure 72: Decision tree representation of the problem facing PanaceaGenix in 62a.

(b) To define the profit maximizing plan, we must define the expected outcomes in each node. The expected values are shown in figure 73, and the optimal choices in each decision node are written in green (with the red options being worse in expectation). Starting from the bottom of the tree, in deciding whether to enter clinical trial 3 in the case of strong success in trial 2, the expected value in billion euros is $(22.25 + 2.25 - 2.25)/3 = 7.4166... \approx 7.4$. This is clearly better than exiting, where the outcome is -1.75 , the cost of stages 1-3.

With a weak success in trial 2, the expected value in billion euros is $\frac{1}{3}(2.25) + \frac{2}{3}(-2.25) = -0.75$. This is still preferred over ending the project, where the outcome would be -1.75 , as previously. The optimal decision after the second trial will be to enter the third trial phase, regardless of the outcome in trial 2.

Thus, when deciding between entering the second phase of trials or ending the project after phase one, we choose between a payoff of -1.25 or the expected value of entering phase two, based on the optimal decision of continuing after phase three: $\frac{1}{3}(7.4166...) + \frac{1}{3}(-0.75) + \frac{1}{3}(-1.75) = 1.6388... \approx 1.6$. The profit-maximizing decision here will be to enter clinical trial 2, as $1.6 > -1.25$.

Similarly, before phase one, we have to choose on entering or not if the R&D was successful. The value of not entering is -1 and the expected value of entering is $0.2 \times -1.25 + 0.8 \times 1.6388... = 1.0611... \approx 1.1 > -1$. The profit maximizing decision is to enter phase 1.

The optimal plan is to begin the R&D and keep starting the next clinical trial phase as long as the previous phase was successful. This means that a weak success in phase 2 is sufficient for entering phase 3. Expected value from continuing after a weak success in phase 2 is negative but better than stopping, because stopping would not undo the costs of earlier phases. In the end, the drug will be sold if and only if at least one of phases 2 and 3 met with strong success. The expected value from following the optimal plan is 30.5 million euros.¹¹

¹¹The numbers in this exercise are of course fictional, but it is a reality that most drug development projects end up losing money, which is compensated by a small chance of very lucrative outcomes. According to DiMasi et al (2016), “The overall probability of clinical success [passing all clinical trial phases is] 11.8%.” <https://doi.org/10.1016/j.jhealeco.2016.01.012>. This includes drugs that never recover their sunk costs.

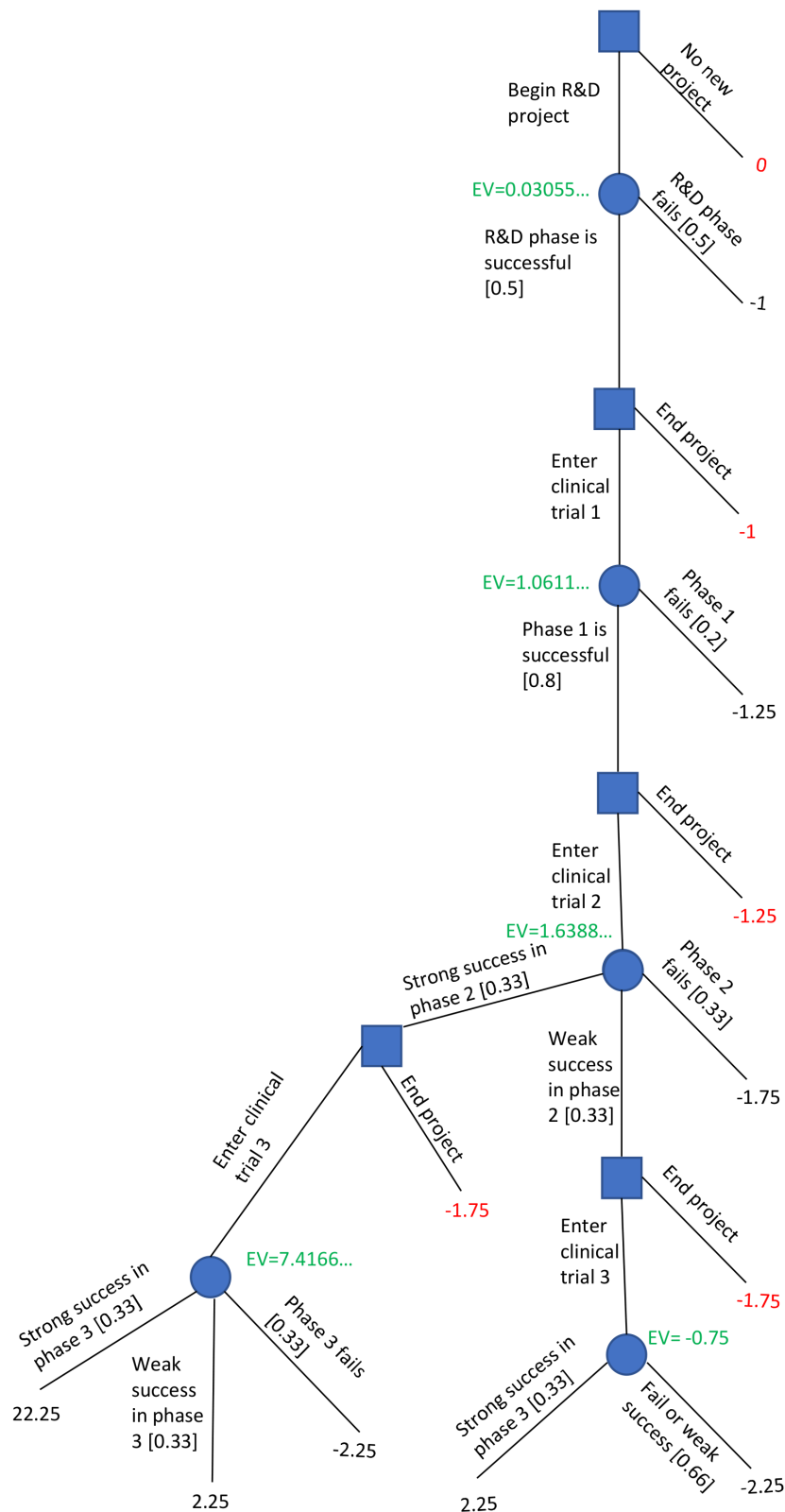

Figure 73: Decision tree representation of the problem facing PanaceaGenix in 62a, now including the expected values from part 62b.

- (c) The optimal decision on beginning the project would change if the expected value of the R&D phase would be negative. To assess the sensitivity to Phase 1 failure, we denote the probability of failure in phase 1 ρ . The value of this for which the optimal decision flips can be solved from the following equation:

$$\begin{aligned}\frac{EV_{Phase1} - 1}{2} < 0 &\Leftrightarrow \\ \frac{(1 - \rho)1.6388... - 1.25\rho - 1}{2} < 0 &\Leftrightarrow \\ 0.819... - 1.444...\rho - 0.5 < 0 &\implies \\ \rho > 0.2218... \approx 0.22\end{aligned}$$

The optimal decision would flip into “do not begin project” if the probability of failure in Phase 1 were to exceed 0.22.

63. (a) Since only one event brings any value, namely the one where all programmers succeed in their respective tasks, the expected value of hiring programmers of type $k \in \{above, average\}$, is

$$E_k(V) = Prob(succes_k) \times V = p_k^n \times V$$

where we used that programmers successes are independent, and hence the probability is the product of the probability that an individual programmer succeeds. So we have:

$$\begin{aligned}E_{avg}(V) &= 0.9^5 \times 100 \approx 59.05 \\ E_{above}(V) &= 0.91^5 \times 100 \approx 62.4,\end{aligned}$$

i.e., the expected value of hiring average and above average programmers is 59 and 62 million euros, respectively.

- (b) Here, we simply equate the expected value net of wages for the two scenarios, and solve for the only unknown, i.e. the pay level of an individual above-average programmer:

$$\begin{aligned}E_{avg}(V) - TC_{avg} &= E(V_{above}) - TC_{above} \\ 0.9^5 \times 100 - 5 \times 0.1 &= 0.91^5 \times 100 - 5 \times w_{above} \\ \implies w_{above}^* &\approx 0.771.\end{aligned}$$

That is, the pay level of above-average programmers is 771k euros.

- (c) Now $V = 200M$ and $n = 10$, and we can proceed as above to solve for w_{above} :

$$\begin{aligned}E_{avg}(V) - TC_{avg} &= E(V_{above}) - TC_{above} \\ 0.9^{10} \times 200 - 10 \times 0.1 &= 0.91^{10} \times 200 - 10 \times w_{above} \\ \implies w_{above}^* &\approx 0.915.\end{aligned}$$

That is, the pay level of above-average programmers increases to 915k euros.

64. (a) First notice that the two markets aren't really intertwined. Marginal costs are constant and therefore producing on one market doesn't affect other market's costs. Marketing is done and distribution network built country by country. There's a strong dichotomy on the demand side as well - selling in one country doesn't satisfy the needs in other.

We have three types of costs here: sunk costs (marketing), fixed costs (having distribution network up) and variable costs (distribution and production cost per unit), which have constant marginal costs. Marketing costs are \$20000 and therefore the recoverable share of entry costs is $600000 - 20000 = 580000$ dollars. The firm faces a fixed opportunity cost of $FC_0 = 600000 \times 0.1 = 60000$ dollars a year for its capital, evaluated pre-entry. Upon entry marketing costs are sunk and fixed cost becomes $FC_1 = 580000 \times 0.1 = 58000$.

Marginal costs are \$10 for unit production plus 2, 12 or 22 euros depending on the market scenario. We assume throughout that both costs and profits are realized in the end of the period. Basically any of the four possible combinations is justifiable as long as these assumptions are articulated.

Let's start with Estonia. We'll first calculate the optimal price and quantity every year given the company has entered. The company will face a marginal cost of $MC_E(q) = MC_E = 10 + 12 = 22$ and collect a marginal revenue of $\frac{\partial}{\partial q} q(125 - 0.05q) = 125 - 0.1q$. Setting these equal and solving for q yields $q_E^* = 1030$. Plugging into demand gives $p_E^* = 73.5$. Yearly profits in the optimum are thus given by $\pi_E^* = (p_E^* - MC_E)q_E^* = 53045$. Present value of the profits before fixed costs, assuming that the profits are realized in the end of the year, $53045(1/(1+0.1)) + 53045(1/(1+0.1))^2 = 53045/0.1 = 530450$. Market entry costs 600000 and therefore the present value of the entry is -69550 so the company will not enter.¹²

In Latvia, our calculations depend on the assumption, at which time the decision of the volume of the production must be made in the first year. If the firm learns the marginal cost after this decision, the best it can do is to maximize the expected profits $E(\pi(q)) = q(125 - 0.05q) - 10q - (0.5 \times 2q + 0.5 \times 12q) = 103q - 0.05q^2$. FOC becomes $103 - 0.1q = 0 \implies q^* = 1030 \implies p^* = 73.5$. First year profits before fixed costs will be $(73.5 - 12)1030 = 63345$ if cost turns out to be low, $(73.5 - 32)1030 = 42745$ in case of high costs.

Upon learning that the cost is high, it's yearly optimum from second year onwards would be derived as $125 - 0.1q = 32 \implies q^* = 930 \implies p^* = 78.5$. Profits before

¹²Numbers will change if we assume sales and variable costs are realized in the start of the period. That would move the stream of profits one year back in time, and give entering Estonia a net present value of -16505.

fixed costs would be $\pi^* = (78.5 - 32) \times 930 = 43245$. If the firm has entered, it can only salvage 580000 of the fixed costs by exiting. Therefore the fixed opportunity cost is $FC_1 = 58000$ dollars a year whereas the firm would only make 43245 a year. Therefore the firm will exit as it can find better use for its money elsewhere.

Present value of firms profits in this scenario is $-20000 - (58000 + 42745)/(1 + 0.1) = -(372550/11) \approx -33868.2$. That is, the marketing cost is sunk, and during the first year an additional 580000 of capital is reserved yielding a fixed opportunity cost of $FC_1 = 58000$. This cost, along with a profit of 42745, are realized in the end of the period. Equivalently, one could think that the firm loses a present value of 600 000 forever, makes little profit in the first year and receives a PV of 580000 in the end of the first year: $-600000 + (580000 + 42745)/(1 + 0.1) \approx -33868.2$.

Should the firm learn that the cost is low, yearly optimum would be $125 - 0.1q = 12 \implies q^* = 1130 \implies p^* = 68.5$. Profits before fixed costs would be $\pi^* = (68.5 - 12) \times 1130 = 63845 > FC_1 = 58000$. Firm would stay in the market, and the present value of the profits would be before entry costs are $63345/(1 + 0.1) + (1/(1 + 0.1))63845/0.1 = 7017950/11 \approx 637995$. Deducting entry costs we get $417950/11 = 37995$.

In expectation the value of entry will be $0.5(-372550 + 417950)/11 = 188775/11 \approx 2064$. Note that although the costs are similar in expectation in the two countries, the option and exiting in an unfortunate case, i.e. option value of experimentation, makes Latvia a more lucrative option.

Problem is somewhat simpler if one assumes that the decision on the volume can be made after observing the marginal cost also in the first year. High costs would yield a net present value of $-20000 - (58000 + 42745)/(1 + 0.1) = -(367550/11) \approx -33414$, low costs $-600000 + 63845/0.1 = 38450$. In expectation the value of entry would be $0.5(-367550/11 + 38450) = 27700/11 \approx 2518$.

- (b) If the firm were to know the costs, it would only enter when cost is low and could set more favourable prices and quantities in the first period, given it doesn't learn the costs in time. Firm would go on producing that quantity indefinitely. If the cost is high, firm would do nothing at all except possibly paying for that information.

Therefore, paying p_I for the information would be at least good as going blindly to the market if $-p_I + 0.5(-600000 + 63845/0.1) \geq 22700/11 \iff p_I \leq 188775/11 \approx 17161$. If the costs are learnt before the production takes place, $-p_I + 0.5(-600000 + 63845/0.1) \geq 27700/11 \iff p_I \leq 183775/11 \approx 16707$.

65. (a) Denote $B = 1/(1.05)$. The net present value of launching the widget now is

$$PV_{N,4} = \underbrace{\frac{1}{3}(4 + 8 + 12)}_{t=0} - 10 + \underbrace{\frac{1}{3}}_{P(N=12)} \left(\underbrace{B(12-10)}_{t=1} + \underbrace{B^2(12-10)}_{t=2} + \underbrace{B^3(12-10)}_{t=3} \right)$$

$$\approx -0.18.$$

That is, there's an expected deficit in the first year and positive profits if it turns out that $N = 12$. Otherwise the firm will not produce at all. Value of waiting is

$$PV_{W,4} = \underbrace{0}_{t=0} + \underbrace{0}_{t=1} + \underbrace{\frac{1}{3}}_{P(N=12)} \left(\underbrace{B^2(12-10)}_{t=2} + \underbrace{B^3(12-10)}_{t=3} \right)$$

$$\approx 1.18.$$

That is, nothing happens in the first two years and starting from $t = 2$, firm will produce only if $N = 12$. $PV_{N,4} < PV_{W,4}$ so waiting is the optimal thing to do.

(b) Clearly waiting is still optimal: profits in year $t \geq 2$ are identical in both scenarios; only the first two years matter for the decision. Present values are

$$PV_{N,\infty} = \underbrace{-2}_{t=0} + \underbrace{\frac{1}{3}}_{P(N=12)} \left(\underbrace{2B}_{t=1} + \underbrace{2B^2}_{t=2} + \underbrace{2B^3}_{t=3} + \dots \right)$$

$$= -2 + \frac{2B}{3} \left(\frac{1}{1-B} \right) = -2 + \frac{2}{3 \times 0.05} \approx 11.33.$$

$$PV_{W,\infty} = \underbrace{0}_{t=0} + \underbrace{0}_{t=1} + \underbrace{\frac{1}{3}}_{P(N=12)} \left(\underbrace{2B^2}_{t=2} + \underbrace{2B^3}_{t=3} + \dots \right)$$

$$= \frac{2B^2}{3} \left(\frac{1}{1-B} \right) = \frac{2}{(1+0.05)3 \times 0.05} \approx 12.70.$$

Note that the difference in the values is exactly the same as with four periods only.

(c) This perturbation neither has effect on optimal decision whereas payoffs are diminished. Now we need to not only discount but take into account that widget may become unavailable in any year $t > 0$. After t years, widget is still valid with probability $(1 - 0.05)^t$ and payoffs are discounted by $1/(1 + 0.05)^t$. Let us embed these two into one, $\tilde{B} = (1 - 0.05)/(1 + 0.05)$. The rest of the logic is just like before. The expectations about obsolescence are now embedded in the corrected discount factor \tilde{B} , so we can treat future income as a perpetuity.

$$\tilde{P}V_{N,\infty} = -2 + \frac{2\tilde{B}}{3} \left(\frac{1}{1-\tilde{B}} \right) \approx 4.33.$$

$$\tilde{P}V_{W,\infty} = \frac{2\tilde{B}^2}{3} \left(\frac{1}{1-\tilde{B}} \right) \approx 5.73.$$

As long as the widget is not obsolete, the future always looks the same. Hence waiting cannot make sense: either the investment is sensible now or never.

66. (a) When p applies to whole R&D process there are two uncertain states of the world; easy and hard. In both states, there is further uncertainty about the success of development. This calls for the use of expected values twice. Let's denote the expected profit of launch under the "easy" and "hard" states of the world respectively as (all units in thousands of euros):

$$P_e = p_e \times 2500 - (1 - p_e) \times 3 \times 200 = 1400$$

$$P_h = p_h \times 2500 - (1 - p_h) \times 3 \times 200 = -100$$

Where $p_e = 0.2$ and $p_h = 0.8$ are the probabilities that R&D is successful in the "easy" and "hard" states of the world. Since both states of the world are equally likely, the total expected profit EP is:

$$EP = 0.5P_e + 0.5P_h = 650$$

How much should the (risk neutral) startup be willing to pay at most to eliminate the "first level" of uncertainty regarding the state of the world? Notice that the expected payoff when R&D is hard is $P_h < 0$. If they find out that development is hard, they will rather not launch at all and take zero! The expected profits for finding out is:

$$EP_{informed} = 0.5P_e + 0.5 \times 0 = 700$$

The value of information is the difference $EP_{informed} - EP = -0.5P_h = 50$. This is how much the partners would be willing to spend at most.

- (b) Now that p applies to each scientist separately the probabilities of success have been altered. Intuitively the probabilities in either state of the world must now be strictly higher, because now each scientist has a separate chance to succeed and only one of them is required to do so in order to develop the device. This is a case of repeated independent trials in which case the distribution of the number of successful scientists follows the binomial distribution. What is the simplest way to calculate the probabilities? Notice that the complement of "at least one scientist is successful" is "everyone fails". This gives us:

$$p_e = 1 - Pr(\text{"everyone fails when success is easy"}) = 1 - 0.2^4 = 0.9984$$

$$p_h = 1 - Pr(\text{"everyone fails when success is hard"}) = 1 - 0.8^4 = 0.59$$

All that is left is to substitute these probabilities into the equations from the previous question to get:

$$P_e = p_e \times 2500 - (1 - p_e) \times 3 \times 200 = 1895$$

$$P_h = p_h \times 2500 - (1 - p_h) \times 3 \times 200 = 875$$

$$EP = 1385$$

In this case the value of information is zero! To understand why, notice that the expected profits are positive irrespective of whether development is easy or hard ($P_h > 0, P_e > 0$). Therefore, knowing the state of the world in advance is worthless because it would not change the decision to launch.

- (c) Now that p applies to each scientist separately the probability of success must intuitively be much lower, since every scientist has to independently succeed. This time we can straightforwardly apply the previous logic:

$$p_e = Pr(\text{"everyone succeeds when it's easy"}) = 0.8^4 = 0.41$$

$$p_h = Pr(\text{"everyone succeeds when it's hard"}) = 0.2^4 = 0.0016$$

$$P_e = p_e \times 2500 - (1 - p_e) \times 3 \times 200 = 425$$

$$P_h = p_h \times 2500 - (1 - p_h) \times 3 \times 200 = -590$$

$$EP = -85.5$$

The partners would not launch this project because they expect a loss. The value of finding out the difficulty is again:

$$EP_{informed} = 0.5P_e + 0.5 \times 0 = 213$$

This time $EP_{informed}$ is not compared to $EP = -590$. The actual profits under no information are zero because the partners won't even start the project. The value of information is in this case is therefore:

$$EP_{informed} - 0 = 0.5P_e = 213$$

- (d) Now that p applies to whole R&D process we add a third level of uncertainty. This time it is about the parameter p of the Bernoulli distribution (the state of the world being either easy or hard), which was specified earlier a fixed value $p = 0.5$. The solution is obtained by taking the expectation of the expected profits EP and noting that $E(p) = 0.5$ (mean of a continuous $[0,1]$ uniform distribution):

$$E(EP) = E[pP_e + (1 - p)P_h] =$$

$$P_e E(p) + P_h - P_h E(p) =$$

$$0.5P_e + 0.5P_h = 650$$

The solution happens to be the same as in 66a. This is because both scenarios (easy/hard) are considered equally likely. Any other mix of probabilities besides 50/50 in question (a) would have resulted in a different outcome.

6 Strategy

67. (a) Let's write down the payoff matrix and find the Nash equilibrium:

		Becme		
		\$m	High	Mid
Acme	High	0,0	50/3,25/3	50,0
	Mid	25/3,50/3	25,25	75,0
	Low	0,50	0,75	50,50

"Low" and "High" are dominated strategies for both players. The unique Nash equilibrium is: {Mid, Mid}.

(b) This is a symmetric game à la Cournot. Let's solve for optimal marketing spending of both of the firms. Optimal spending is the choice of x that maximizes a firm's profits. The profit function of Acme is:

$$\begin{aligned} \Pi_A(x_A, x_B) &= \text{MarketShare} \times \text{Customers} - \text{MarketingSpend} \\ &= \frac{x_A}{x_A + x_B} \times 100 - x_A \end{aligned}$$

Let's differentiate this with respect to x_A :

$$\frac{\partial \Pi_A(x_A, x_B)}{\partial x_a} = \frac{x_B}{(x_A + x_B)^2} \times 100 - 1 = 0$$

Solving the above for x_A would give us the best response function of Acme. However, Since the problem is symmetric, we know that optimal marketing spending will be the same for both firms: $x_A^* = x_B^* = x^*$. Thus, the above simplifies:

$$\begin{aligned} 100 \times \frac{x}{(x + x)^2} - 1 &= 0 \\ 100 \times \frac{1}{4x} &= 1 \\ x^* &= 25 \end{aligned}$$

$x^* = 25$ is the optimal marketing spending for both firms. The Nash equilibrium spending is thus {25, 25}.

(c) The possible customer numbers are:

Aggregate marketing spending (\$m)	Total customers (thousands)
100	$32\sqrt{100} = 320$
75	$32\sqrt{75} \approx 277.1$
50	$32\sqrt{50} \approx 226.3$
25	$32\sqrt{25} = 160$
0	$32\sqrt{0} = 0$

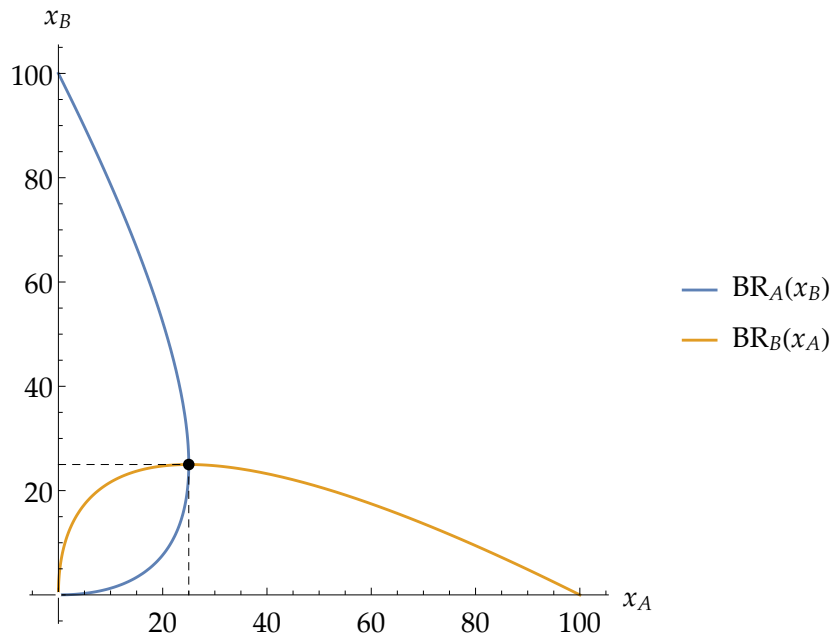

Best response functions in 67b.

The payoff matrix then becomes (payoffs rounded to nearest integer):

		Becme		
		\$m	High	Mid
Acme	High	110,110	135,67	176,0
	Mid	67,135	88,88	135,0
	Low	0,176	0,135	0,0

The unique Nash equilibrium is: {High,High}¹³

68. (a) The profit function of Acme is:

$$\begin{aligned} \Pi_A(Q_A, Q_B) &= P^D(Q_A, Q_B)Q_A - TC_A(Q_A) \\ &= (100 - 2(Q_A + Q_B))Q_A - 20Q_A - 200 \\ &= -2Q_A^2 - 2Q_AQ_B + 80Q_A - 200 \end{aligned}$$

The profit function of Bonk is otherwise identical, but with a lower marginal cost:

$$\begin{aligned} \Pi_B(Q_A, Q_B) &= P^D(Q_A, Q_B)Q_B - TC_B(Q_B) \\ &= (100 - 2(Q_A + Q_B))Q_B - 10Q_B - 200 \\ &= -2Q_B^2 - 2Q_AQ_B + 90Q_B - 200 \end{aligned}$$

¹³With a continuous advertising choice $x > 0$, both spend $x = 72$ on advertising in equilibrium, with payoffs {110, 110}. To answer this version of the question it suffices to show which numerical problem you solved.

The same actions are available to both players, $Q_i \in \{0, 1, 2\}$. However, the game is not symmetric because Bonk faces lower variable cost. Plugging in the different combinations of actions in in the above profit functions we get the payoff matrix:

		Bonk		
		0	1	2
Acme	€k			
	0	0,0	0,392	0,728
	1	312,0	184,264	56,472
	2	568,0	312,136	56,216

- (b) Bonk has a dominant strategy of sending out two vessels. Knowing this, Acme is indifferent between sending out one or two vessels. So we know that, in Nash equilibrium, Acme sends out either one or two vessels and Bonk sends out two vessels.¹⁴
 - (c) Bonk has a dominant strategy so any espionage capabilities and their disclosure can make no difference to it.
69. (a) A player picking at speed x l/h obtains $\text{€}16x$ of value per hour while suffering effort cost $\text{€}x^2$. While there are chanterelles left the per-hour value function is $16x_i - x_i^2$ where $i \in \{A, B\}$ denotes the player (Alice or Bernard). To get their payoffs we also need to figure out how many hours they picking will last before the patch is empty. It takes t hours to pick all 24 liters, so that $x_A t + x_B t = 24 \implies t = 24/(x_A + x_B)$. Combining costs and benefits gives the value function

$$V_i(x_i, x_j) = \frac{24}{x_i + x_j}(16x_i - x_i^2) = \frac{384x_i - 24x_i^2}{x_i + x_j},$$

where x_j denotes the choice of the other player. Plugging in the 4×4 combinations of possible actions $x \in \{0, 2, 4, 6\}$ into the value function yields the payoff matrix:¹⁵

		B			
		0	2	4	6
A	0	0, 0	0, 336	0, 288	0, 240
	2	336, 0	168, 168	112, 192	84, 180
	4	288, 0	192, 112	144, 144	115.2, 144
	6	240, 0	180, 84	144, 115.2	120, 120

In Nash equilibrium a unilateral change in strategy is not profitable for any player. First let's see if there are any dominated strategies, i.e., strategies that are never

¹⁴Acme would also be indifferent with any mixing probabilities between sending out one or two vessels. Here mixing would not add any Nash equilibrium outcomes to the game.

¹⁵It makes sense to do this many formulaic calculations with a computer, e.g., with Excel or Python.

the best response for a player no matter what the other player does. It is quickly apparent that not doing any picking ($x_i = 0$) is not the best response to anything and can be eliminated. This simplifies the payoff matrix to:

		B		
		2	4	6
A	2	168, 168	112, 192	84, 180
	4	192, 112	144, 144	115.2, 144
	6	180, 84	144, 115.2	120, 120

Now in the top row we see that no matter what Bernard does, 2 is never Alice’s best response. Since the game is symmetric, the same holds for Bernard, and the game simplifies further to:

		B	
		4	6
A	4	144, 144	115.2, 144
	6	144, 115.2	120, 120

In the remaining 2×2 game we can quickly find the Nash equilibria by “brute force” reasoning. Considering each of the four possible outcomes in turn, we see that neither would want to deviate from the top left $\{4,4\}$ or bottom right $\{6,6\}$ outcomes, so these are Nash equilibria. (There is also a third Nash equilibria, which would involve mixing between speeds 4 and 6, but it is not particularly interesting here so let’s ignore it.)

A socially efficient state maximizes the sum of the players’ payoffs. While $\{4,4\}$ is the Nash equilibrium with the highest total payoff, it is not socially efficient. In the full 4×4 payoff matrix $\{2,2\}$ yields both players a higher payoff, summing to a total payoff of 336. Outcomes where one player picks 0 and the other 2 yield the same total payoff, just all going to one player. Intuitively, the effort cost of picking the chanterelles is minimized at picking speed 2, while benefits are not affected by the (nonzero) speed. With this effort cost structure, it doesn’t matter how the picking hours are distributed between the players, so all choice combinations $\{0,2\}$, $\{2,0\}$ and $\{2,2\}$ are socially efficient.

- (b) Now that players have what are known as “social” or “other-regarding” preferences, using the symmetric value function derived in part 69a, the value function becomes

$$\hat{V}_i(x_i, x_j) = 0.75V_i(x_i, x_j) + 0.25V_j(x_j, x_i) = \dots = \frac{288x_i - 18x_i^2 + 6(16 - x_j)x_i}{x_i + x_j},$$

Again, plugging in all 4×4 combinations of choices, the payoff matrix becomes:

		B			
		0	2	4	6
A	0	0, 0	84, 252	72, 216	60, 180
	2	252, 84	168, 168	132, 172	108, 156
	4	216, 72	172, 132	144, 144	122.4, 136.8
	6	60, 180	156, 108	136.8, 122.4	120, 120

The choice $x_i = 0$ remains dominated, as does $x_i = 2$. This leaves us with the same 2×2 -game of undominated strategies as in 69a. However, $\{6,6\}$ is no longer a Nash equilibrium, since either player can now profitably deviate from it by choosing 4. Checking the remaining outcomes one by one leaves $\{4,4\}$ as the unique Nash equilibrium in this game. These social preferences (captured by $\beta = 0.25$) are strong enough to deter the most inefficiently speedy picking of chanterelles at 6 l/h, but not strong enough to induce the socially efficient picking speed 2 l/h.

- (c) Notice that only Alice’s cost and hence her payoffs change. Her value function is now

$$V_A(x_A, x_B) = \frac{24}{x_A + x_B} (16x_A - 0.5x_A^2) = \frac{384x_A - 12x_A^2}{x_A + x_B},$$

while Bernard’s is unchanged from part 69a. The payoff matrix is now

		B			
		0	2	4	6
A	0	0, 0	0, 336	0, 288	0, 240
	2	360, 0	180, 168	120, 192	90, 180
	4	336, 0	224, 112	168, 144	134.4, 144
	6	312, 0	234, 84	187.2, 115.2	156, 120

As before, the zero speed strategies are dominated. As Bernard’s values haven’t changed picking at 2 l/h is still dominated for him, but since the game is no longer symmetric, this does not guarantee that 2 would also be dominated for Alice. A quick check reveals that 2 remains dominated for Alice as well, so we are again left with a 2×2 -game with actions 4 and 6. Now $\{4,4\}$ is no longer a Nash equilibrium, since Alice could increase her payoff by switching to 6. From $\{6,4\}$ Bernard has a profitable deviation, and from $\{4,6\}$ Alice could deviate to 6 to get a higher payoff. Thus $\{6,6\}$ is now the unique Nash equilibrium.

Now that Alice has a lower cost of picking the socially efficient outcome has to involve her doing all the picking. She achieves the lowest picking cost at 2 l/h, so $\{2,0\}$ would be the socially efficient choice.

- (d) Bernard’s ability to publicly commit to a picking a speed turns the situation into a sequential game. In effect, Bernard can pick the column in the full payoff matrix seen

in part 69a, knowing that Alice will then pick the row that maximizes her payoff. Here is the payoff matrix with Alice's payoff under her best responses in bold:

		B			
		0	2	4	6
A	0	0, 0	0, 336	0, 288	0, 240
	2	336 , 0	168, 168	112, 192	84, 180
	4	288, 0	192 , 112	144 , 144	115.2, 144
	6	240, 0	180, 84	144 , 115.2	120 , 120

The only complication for Bernard is that if he were to commit to 4 then Alice is left indifferent between picking 4 or 6. This could lead to Bernard getting a payoff of either 144 or 115.2, one of which is better and the other worse than the guaranteed 120 that he will get from committing to 6. There are two outcomes that can be rationalized as equilibrium outcomes (and either one is acceptable as the correct bottom line answer in this part). In one Bernard commits to 6 and Alice picks 6. In the other Bernard commits to 4 and Alice picks 4. The latter is weak (a bit shaky) in the sense that Alice has only a weak preference for using the purported equilibrium strategy.

As a side note, in this sequential game Alice's fully formulated strategy consists of a list of responses, one for each of the four possible choices by Bernard. She has two relevant strategies that only differ at her response to $x_B = 4$. If she is playing the strategy where she responds to 4 by 4 then $\{4, 4\}$ is the equilibrium outcome. If she is playing the strategy where she responds to 4 by 6 then $\{6, 6\}$ is the equilibrium outcome. This shows that, as is the case under simultaneous games, there are sequential games where the equilibrium depends on players' beliefs about what the other player will do.

70. (a) Since the companies are choosing the size of their operations rather than the price, let us first rearrange the demand to get the price at a given supply: $Q = 60 - 12p \implies 12p = 60 - Q \implies p(Q) = 5 - \frac{1}{12}Q$. Note that $Q = q_A + q_B$, i.e. the total amount of unobtainium in the market is the sum of the amounts supplied by the two companies. The profits for Alpha Inc are then given by $\Pi_A(q_A, q_B) = (5 - \frac{1}{12}(q_A + q_B))q_A - 2q_A - 4$ and for Beta Corp symmetrically. Maximizing the profit function with respect to q_A yields Alpha Inc's best response as a function of Beta Corp's supply:

$$\begin{aligned} \frac{\partial \Pi_A(q_A, q_B)}{\partial q_A} &= \frac{\partial (5q_A - (1/12)q_A^2 - (1/12)q_Aq_B - 2q_A - 4)}{\partial q_A} = 0 \\ &\implies 5 - \frac{1}{6}q_A - \frac{1}{12}q_B - 2 = 0 \\ &\implies q_A^*(q_B) = 30 - \frac{1}{2}q_B - 12 \end{aligned}$$

By symmetry the best response function for Beta Corp is $q_B^*(q_A) = 30 - \frac{1}{2}q_A - 12$. To figure out the equilibrium supplies, we can then plug one company's best response function into the other's:

$$\begin{aligned} q_A^*(q_B^*(q_A)) &= 30 - \frac{1}{2}\left(30 - \frac{1}{2}q_A - 12\right) - 12 \\ &= 30 - 15 + 6 - 12 + \frac{1}{4}q_A \\ &\implies \left(1 - \frac{1}{4}\right)q_A = 9 \implies q_A = 12 \end{aligned}$$

Again by symmetry, $q_B = 12$ as well, implying that $Q = 12 + 12 = 24 = 60 - 12p \implies p = 3$. The profits for both companies are thus $\Pi_i = 3 \times 12 - 2 \times 12 - 4 = 8$.

- (b) Beta's profit function after the investment would be $\Pi_B(q_B, q_A) = p(q_A, q_B)q_B - 1.5q_B - 6$. Similar derivation as in 70a yields Beta's new best response function $q_B^*(q_A) = 30 - \frac{1}{2}q_A - 9$. If beta hides the investment from Alpha, Alpha will continue to supply $q_A = 12$, making Beta's best response $q_B = 15$, which implies that $Q = 27 = 60 - 12p \implies p = 2.75$. Beta's profit is then $\Pi_B = 2.75 \times 15 - 1.5 \times 15 - 6 = 12.75$, which is more than it made without the investment, so making the investment and hiding it from Alpha is worth it.

However, it remains to check whether Beta would want to hide its investment. If it doesn't, Alpha's best response can be figured out by plugging Beta's (correct) best response function to Alpha's best response function from 70a:

$$\begin{aligned} q_A^*(q_B^*(q_A)) &= 30 - \frac{1}{2}\left(30 - \frac{1}{2}q_A - 9\right) - 12 \\ &= 30 - 15 + 4.5 - 12 + \frac{1}{4}q_A \\ &\implies \left(1 - \frac{1}{4}\right)q_A = 7.5 \implies q_A = 10 \end{aligned}$$

This means that Beta's best response is $q_B = 30 - 5 - 9 = 16$, and $Q = 26 = 60 - 12p \implies p = \frac{17}{6}$, so it makes a profit of $\Pi_B = \frac{17}{6} \times 16 - 1.5 \times 16 - 6 \approx 15.33$. Thus, Beta makes an even higher profit when Alpha knows about its investment.

- (c) As Alpha gets to launch its ship first, Beta can only react to whatever Alpha did with its best response. Knowing this, Alpha can simply plug Beta's best response straight into its profit function:

$$\begin{aligned} \Pi_A(q_A) &= 5q_A - (1/12)q_A^2 - (1/12)q_A\left(30 - \frac{1}{2}q_A - 12\right) - 2q_A - 4 \\ &= -\frac{1}{24}q_A^2 + \frac{3}{2}q_A - 4 \end{aligned}$$

Maximizing this with respect to q_A yields Alpha's strategy:

$$\begin{aligned} \frac{\partial \Pi_A(q_A)}{\partial q_A} &= \frac{3}{2} - \frac{1}{12}q_A = 0 \\ &\implies q_A = 18 \end{aligned}$$

This means that $q_B = 30 - \frac{1}{2} \times 18 - 12 = 9$ and $Q = 18 + 9 = 27 = 60 - 12p \implies p = 2.75$. The profits are then $\Pi_A = 2.75 \times 18 - 2 \times 18 - 4 = 9.5$ and $\Pi_B = 2.75 \times 9 - 2 \times 9 - 4 = 2.75$.

- (d) Suppose Alpha launches first. If Beta's investment is hidden, Alpha still thinks Beta is going to respond as if it had not made the investment. Hence Alpha's strategy is exactly the same as in 70c, i.e. $q_A = 18$. Meanwhile Beta's best response function is now as in 70b: $q_B^*(q_A) = 30 - \frac{1}{2}q_A - 9 \implies q_B^*(18) = 30 - \frac{1}{2} \times 18 - 9 = 12$. This means that $Q = 30 = 60 - 12p \implies p = 2.5$. The equilibrium profits are $\Pi_A = 2.5 \times 18 - 2 \times 18 - 4 = 5$ and $\Pi_B = 2.5 \times 12 - 1.5 \times 12 - 6 = 6$. What if Beta had not hidden the investment? Then Alpha would plug the correct best response for Beta in its profit function and maximize

$$\begin{aligned}\Pi_A(q_A) &= 5q_A - (1/12)q_A^2 - (1/12)q_A(30 - \frac{1}{2}q_A - 9) - 2q_A - 4 \\ &= 1.25q_A - \frac{1}{24}q_A^2 - 4\end{aligned}$$

Maximizing this with respect to q_A yields Alpha's strategy:

$$\begin{aligned}\frac{\partial \Pi_A(q_A)}{\partial q_A} &= 1.25 - \frac{1}{12}q_A = 0 \\ \implies q_A &= 15\end{aligned}$$

Beta's best response is $q_B^*(18.5) = 30 - \frac{1}{2} \times 15 - 9 = 13.5$, which means that $Q = 28.5 = 60 - 12p \implies p = 2.625$. The equilibrium profits in this case would be $\Pi_A = 2.625 \times 15 - 2 \times 15 - 4 = 5.375$ and $\Pi_B = 2.625 \times 13.5 - 1.5 \times 13.5 - 6 = 9.1875$. Suppose then Beta launches first. Notice that from the point of view of Alpha's response, it doesn't matter if Beta has made the investment or not, or if Alpha knows about the investment or not. All Alpha cares about is the actual quantity supplied by Beta. It's best response function is exactly the same as in 70a: $q_A^*(q_B) = 30 - \frac{1}{2}q_B - 12$. Beta plugs this into its post-investment profit function $\Pi_B(q_B, q_A) = p(q_A, q_B)q_B - 1.5q_B - 6$ and maximizes with respect to q_B .

$$\begin{aligned}\frac{\partial (5q_B - (1/12)q_B^2 - (1/12)q_B(30 - \frac{1}{2}q_B - 12) - 1.5q_B - 6)}{\partial q_B} &= 2 - \frac{1}{12}q_B = 0 \\ \implies q_B &= 24\end{aligned}$$

Alpha's best response is then $q_A^*(24) = 30 - \frac{1}{2} \times 24 - 12 = 6$, which means that $Q = 30 = 60 - 12p \implies p = 2.5$ and the profits are $\Pi_A = 2.5 \times 6 - 2 \times 6 - 4 = -1$ and $\Pi_B = 2.5 \times 24 - 1.5 \times 24 - 6 = 18$. Note that the firms are only deciding on their capacity - the fixed costs of building the ship are sunk - so Alpha will provide $q_A = 6$ even when that means a loss (any other q_A would yield an even larger loss).

71. (a) The profits for Ann are:

$$\pi_a = (240 - 15p_a + 10p_b)p_a - (240 - 15p_a + 10p_b)20 - 500$$

Ann optimizes wrt p_a :

$$\frac{\partial \pi_a}{\partial p_a} = 240 - 30p_a + 10p_b + 300 = 0$$

$$p_a^*(p_b) = 18 + \frac{1}{3}p_b$$

Due to symmetry, we can write:

$$p_a^*(p_b^*) = 18 + \frac{1}{3}(18 + \frac{1}{3}p_a^*)$$

$$p_a^* = p_b^* = 27$$

And profits are:

$$\pi = (240 - 15 \times 27 + 10 \times 27) \times 27 - (240 - 15 \times 27 + 10 \times 27)20 - 500 = 235$$

(b) Now Bob doesn't face a strategic decision, but chooses $p_b = 18 + \frac{1}{3}p_a$ in a deterministic way. Ann knows this and maximizes:

$$\pi_a = (240 - 15p_a + 10(18 + \frac{1}{3}p_a))p_a -$$

$$(240 - 15p_a + 10(18 + \frac{1}{3}p_a))20 - 500$$

Maximizing wrt p_a :

$$\frac{\partial \pi_a}{\partial p_a} = 0$$

$$p_a^* = 28$$

$$p_b^* = 18 + \frac{1}{3}28 = 27.333$$

And profits are:

$$\pi_a(28) = 247$$

$$\pi_b(27.33) = 307$$

In this case leader (Ann) has a disadvantage because the follower can undercut slightly and take a share of the leader's customers.

(c) Due to symmetry, same as 71b, except names reversed.

(d) Due to symmetry, profits are maximized at $p_a = p_b := p$.

$$\begin{aligned}\pi &= (240 - 5p)p - (240 - 5p)20 - 500 \\ \frac{\partial \pi}{\partial p} &= 240 - 10p + 100 = 0 \\ p^* &= 34 \\ \pi^* &= 480\end{aligned}$$

Both the price and profits are higher than in part 71a. If Ann and Bob were to coordinate their pricing, e.g., by merging their businesses, this would be good for their profits but bad for their consumers.

72. (a) The demand for Ann's coffee is $Q_A^D(p_A, p_B) = 2400 - 200p_A - 100p_B$ and the demand for Bob's pulla is symmetric. The prices are in euros and quantities in units per day. The marginal costs are 2 euro per unit for each firm and the daily fixed cost is 500 euros. Therefore, we can denote profits for Ann as

$$\begin{aligned}\pi_A(p_A, Q_A^D(p_A, p_B)) &= (p_A - 2)Q_A^D(p_A, p_B) - 500 \\ &= (p_A - 2)(2400 - 200p_A - 100p_B) - 500 \\ &= 2400p_A - 200p_A^2 - 100p_Ap_B - 4800 + 400p_A + 200p_B - 500 \\ &= -200p_A^2 + 2800p_A - 100p_Ap_B + 200p_B - 5300\end{aligned}$$

To find Ann's best response, we differentiate π_A in terms of p_A and solve the first order condition.

$$\begin{aligned}\frac{\partial \pi_A(p_A, Q_A^D(p_A, p_B))}{\partial p_A} &= -400p_A + 2800 - 100p_B = 0 \\ p_A &= \frac{2800 - 100p_B}{400} \\ BR_A(p_B) &= \frac{28 - p_B}{4}\end{aligned}$$

Due to symmetry, both companies have this same Best Response function and will use the same price in equilibrium. We only have one equation to solve: $p = BR(p)$.

$$\begin{aligned}p &= \frac{28 - p}{4} \\ 4p &= 28 - p \\ 5p &= 28 \\ p &= \frac{28}{5} = 5.6\end{aligned}$$

With this price, the profit is

$$\begin{aligned} \pi &= -200 \times \left(\frac{28}{5}\right)^2 + 2800 \times \frac{28}{5} - 100\left(\frac{28}{5}\right)^2 + 200 \times \frac{28}{5} - 5300 \\ &= -300 \times \left(\frac{28}{5}\right)^2 + 3000 \times \frac{28}{5} - 5300 \\ &= 2092 \end{aligned}$$

which, due to symmetry, is the same for both firms.

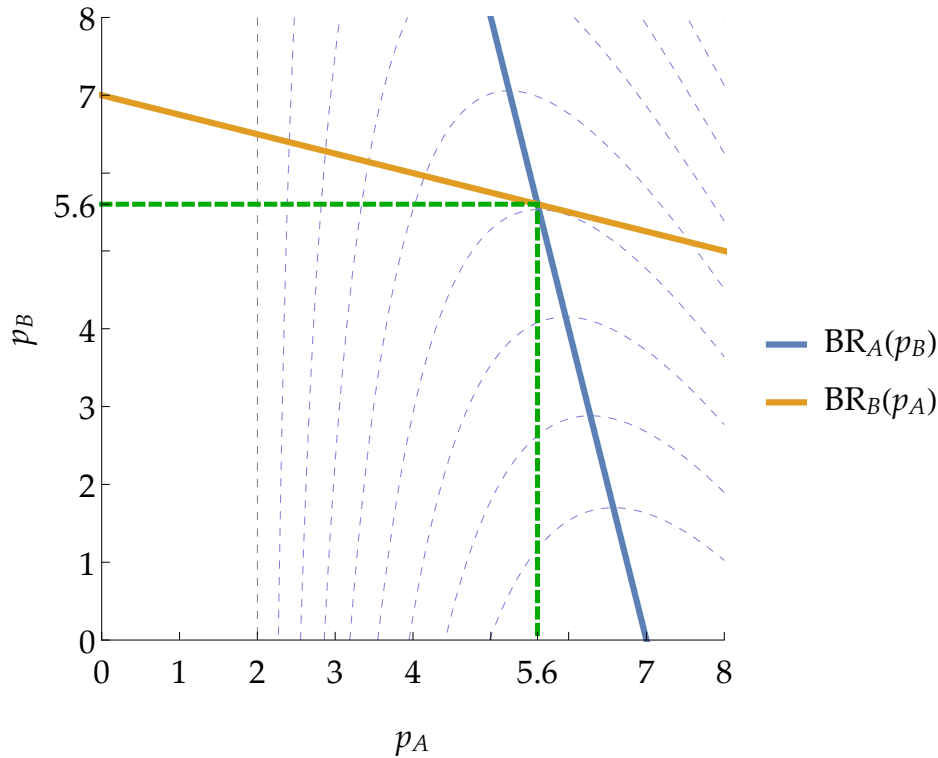

Figure 74: Best responses of both players in strategy space $\{p_A, p_B\}$. Dashed blue curves represent the isoprofit curves for Ann's cafe.

- (b) Now Ann is the first-mover. Thus, Ann's profit function includes Bob's best response instead of just the price.

$$\begin{aligned} \pi_A(p_A) &= (p_A - 2)(2400 - 200p_A - 100BR_B(p_A)) - 500 \\ &= (p_A - 2)\left(2400 - 200p_A - 100 \times \frac{28 - p_A}{4}\right) - 500 \\ &= (p_A - 2)(2400 - 200p_A - 700 + 25p_A) - 500 \\ &= 2400p_A - 200p_A^2 - 700p_A + 25p_A^2 - 4800 + 400p_A + 1400 - 50p_A - 500 \\ &= 2050p_A - 175p_A^2 - 3900 \end{aligned}$$

Hence, Ann's best response is

$$\frac{\partial \pi_A(p_A)}{\partial p_A} = -350p_A + 2050 = 0$$

$$p_A = \frac{2050}{350} = \frac{41}{7} \approx 5.86$$

Bob observes this and thus, his best response is

$$BR_B\left(\frac{41}{7}\right) = \frac{28 - \frac{41}{7}}{4} = \frac{196 - 41}{7 \times 4} = \frac{155}{28} \approx 5.54$$

The profits are

$$\pi_A = 2050 \times \frac{41}{7} - 175 \times \left(\frac{41}{7}\right)^2 - 3900 \approx 2103$$

$$\pi_B = \left(\frac{155}{28} - 2\right)(2400 - 200 \times \frac{155}{28} - 100 \times \frac{41}{7}) - 500 \approx 2000$$

- (c) If Bob is the first-mover instead of Ann, then, due to symmetry, the results are the same only the names are swapped.
- (d) Now Ann and Bob merge their companies. Combine the profit functions of Ann and Bob.

$$\begin{aligned} \pi(p_A, p_B) &= (p_A - 2)(2400 - 200p_A - 100p_B) + (p_B - 2)(2400 - 200p_B - 100p_A) - 1000 \\ &= -200p_A^2 + 2800p_A - 100p_Ap_B + 200p_B - 100p_Ap_B - 200p_B^2 \\ &\quad + 2800p_B + 200p_A - 100p_Ap_B - 10600 \\ &= 200p_A^2 - 200p_B^2 + 3000p_A + 3000p_B - 200p_Ap_B - 10600 \end{aligned}$$

Take partial derivatives, equate to zero, and solve.

$$\frac{\partial \pi(p_A, p_B)}{\partial p_A} = -400p_A + 3000 - 200p_B = 0$$

$$p_B = 15 - 2p_A$$

$$\frac{\partial \pi(p_A, p_B)}{\partial p_B} = -400p_B + 3000 - 200p_A = 0$$

$$p_A = 15 - 2p_B$$

Thus,

$$p_A = 15 - 2(15 - 2p_A) = 15 - 30 + 4p_A$$

$$3p_A = 15 \implies p_A = 5$$

and therefore $p_B = 15 - 2 \times 5 = 5$.

The pricing decisions of Ann and Bob affect each others' profits. By coordinating their pricing they can increase their profits (logically, there is no way that coordination could make them worse off). Here the coordinated prices $p_A = p_B = 5$ are lower than the prices the companies charged separately in part 72a. This is because they sell complements: a lower price for Bob's pulla increases the demand for Ann's coffee, and vice versa. The merger increases their combined profits because now they take into account this spillover effect in their pricing. The merger also makes consumers better off because they get lower prices for both products. The fact that the companies produce complements rather than substitutes makes all the difference!

73. (a) Let's start by formulating the payoff matrix for Mr Montana and the Tax authority (in millions of dollars). Let's define the case where he is not caught as the zero payoff for Montana. Then in cases where the Tax authority chooses the same mansion his payoff is -1. If the tax authority raids any mansion that adds a payoff of -0.2, if they manage to match Montana's choice they get cash worth +1 and so the payoff is 0.8. Tax authority could also choose to not raid any mansion, in which case the payoff is 0 for both.

		Mr Montana		
		\$m	A	B
Tax authority	A	0.8,-1	-0.2,0	-0.2,0
	B	-0.2,0	0.8,-1	-0.2,0
	C	-0.2,0	-0.2,0	0.8,-1
	None	0,0	0,0	0,0

Mr Montana's payoffs can be defined either as losses relative to keeping the money or as gains relative to losing the money.

There can be no pure strategy Nash equilibria in this game, because the authority wants to match Mr Montana's choice while Mr Montana wants to avoid the authority's choice. The best a player can do in equilibrium is to keep the other player guessing and indifferent between their actions. Thus the Nash equilibrium will be in mixed strategies.

Notice that the game is symmetric with respect to the mansions for both players. Mr Montana will therefore use each of the three mansions with equal probability, $1/3$. His expected payoff for this is $(2/3)0 + (1/3)(-1) = -1/3$. This is better than the 40% tax ($\tau = 0.4$), so Mr. Montana will hide his money.

No matter which mansion the tax authority raids its expected value is $(1/3)0.8 + (2/3)(-0.2) = 2/15$. This is better than the zero from not raiding any mansion, which is therefore indeed a dominated strategy and will not be part of the mixed

strategy. The authority will also mix between all mansions with equal probability $1/3$.

As always, the mixing probabilities could also be solved from the players' indifference conditions. The tax authority is indifferent between the mansions if Mr Montana selects them with probabilities $\{p_A, p_B, 1 - p_A - p_B\}$ such that $V_T = 0.8p_A - 0.2p_B - 0.2(1 - p_A - p_B)$, $V_T = -0.2p_A + 0.8p_B - 0.2(1 - p_A - p_B)$, and $V_T = -0.2p_A - 0.2p_B + 0.8(1 - p_A - p_B)$. This is a system of three linear equations with three unknowns, which is straightforward to solve for $p_A = 1/3, p_B = 1/3, V_T = 2/15$. The expected value from choosing not to raid is $0 < V_T$ and thus indeed dominated.

Similarly, Mr Montana is indifferent when the tax authority selects mansions with probabilities $\{q_A, q_B, 1 - q_A - q_B\}$ such that $V_M = -1q_A$, $V_M = -1q_B$, and $V_M = -1(1 - q_A - q_B)$, which holds when $q_A = 1/3, q_B = 1/3, V_M = -1/3$.

- (b) Mr. Montana is indifferent between paying the taxes and hiding the money, if $E[\text{HIDE}] = E[\text{PAY}]$. This point is at $\tau = \frac{1}{3}$.

The expected value for Mr. Montana as a function of the tax rate τ is:

$$E[\text{PAYOFF}_{\text{Montana}}] \begin{cases} E[\text{PAY}] = (1 - \tau) \times \$1m & , \text{ if } \tau \leq \frac{1}{3} \\ E[\text{HIDE}] \approx \$0.67m & , \text{ if } \tau > \frac{1}{3} \end{cases}$$

- (c) The new payoff matrix for Mr. Montana and the Tax authority:

		Mr Montana		
		A	B	C
Tax authority	\$m			
	A	1.8,-4	-0.2,0	-0.2,0
	B	-0.2,0	1.8,-3	-0.2,0
	C	-0.2,0	-0.2,0	1.8,-2
None		0,0	0,0	0,0

There can be no pure strategy Nash equilibria in this game, because the authority wants to match Mr Montana's choice while Mr Montana wants to avoid the authority's choice. The best a player can do in equilibrium is to keep the other player guessing and indifferent between their actions. Thus the Nash equilibrium will be in mixed strategies.

Not raiding a mansion is again a dominated strategy, since the expected payoff for the Tax authority is strictly higher than it was in part 73a, where not raiding was also a dominated strategy.

Let's find the mixed strategy Nash equilibrium by setting up and solving the indifference conditions of both players the same way as above.

$$\text{Mr. Montana: } \begin{cases} V_M = -4q_A \\ V_M = -3q_B \\ V_M = -2(1 - q_A - q_B) \end{cases}$$

$$\text{Solution: } \{q_A, q_B, V_M\} = \left\{ \frac{3}{13}, \frac{4}{13}, \frac{-12}{13} \right\}$$

$$\text{Tax Authority } \begin{cases} V_T = 1.8p_A - 0.2p_B - 0.2(1 - p_A - p_B) \\ V_T = -0.2p_A + 1.8p_B - 0.2(1 - p_A - p_B) \\ V_T = -0.2p_A + -0.2p_B + 1.8(1 - p_A - p_B) \end{cases}$$

$$\text{Solution: } \{p_A, p_B, V_T\} = \left\{ \frac{1}{3}, \frac{1}{3}, \frac{7}{15} \right\}$$

The Nash equilibrium is $\{\{p_A, p_B, p_C\}, \{q_A, q_B, q_C\}\} = \left\{ \left\{ \frac{1}{3}, \frac{1}{3}, \frac{1}{3} \right\}, \left\{ \frac{3}{13}, \frac{4}{13}, \frac{6}{13} \right\} \right\}$

74. (a) Taking into account the costs, the payoff function for a scooter firm participating in a market of n firms is (in €m):

$$\Pi(n) = 24/n - 15$$

The number of active firms n is either 0, 1 or 2. By plugging in the above function $n = 1$ and $n = 2$ and by knowing that action "Out" yields a zero payoff, we get the following payoff matrix (where n corresponds to the number of players choosing "In"):

		B	
		Out	In
A	Out	0,0	0,9
	In	9,0	-3,-3

- (b) There are two pure strategy Nash equilibria: {In,Out} and {Out,In}. Both firms would prefer to be the one that stays in while the other one moves out of the market. The game is symmetric so there is must also be a symmetric Nash equilibrium, and the only remaining possibility is that it is in mixed strategies. Denote the probability of choosing "Out" with p .

		p	$1-p$
		Out	In
p	Out	0,0	0,9
$1-p$	In	9,0	-3,-3

For example, to make player B mix, player A has to choose p so that B is indifferent between playing "Out" and "In". Let's solve for the p that satisfies this condition:

$$\begin{aligned} 0 \times p + 0 \times (1 - p) &= 9 \times p - 3 \times (1 - p) \\ 0 &= 9p - 3 + 3p \\ p &= 1/4 \end{aligned}$$

Due to symmetry, in the mixed strategy Nash equilibrium, both players stay "Out" with probability 1/4 and "In" with probability 3/4.

- (c) Let's express the three-player game as two payoff matrices, where the left matrix shows payoffs for A, B and C when C plays "Out", and the right matrix shows payoffs for A, B and C when C plays "In". We also need to compute one additional payoff value for the case where all three players play "In": $\Pi(3) = -7$. The payoff matrices become:

		C plays "Out"		C plays "In"			
		B		B			
		€m	Out	In	€m	Out	In
A	Out	0,0,0	0,9,0	0,0,9	0,-3,-3		
	In	9,0,0	-3,-3,0	-3,0,-3	-7,-7,-7		

- (d) In a symmetric equilibrium all players use the same strategy. In pure strategies, the symmetric cases would be {Out,Out,Out} and {In,In,In}. However, these are not Nash equilibria, since players have profitable deviations from them.

Let's then look at mixed strategies. The game is still symmetric, because we can swap the labels between players without having to change the numbers in the payoff matrices. Therefore we can still just look for a symmetric mixed strategy Nash equilibrium, where each player plays "Out" with probability p . In equilibrium, p needs to be such that a firm is indifferent between playing "Out" and playing "In". We know that the payoff of playing "Out" is zero. Thus, we need to find the p that yields zero expected profits for playing "In".

Consider the game from the point of view of a firm choosing to stay "In" the market. The below table describes the probabilities for the number of other firms staying "Out" and the resulting payoffs for this firm.

No. of other firms staying "Out"	Probability of event	Payoff for this firm staying "In"
2	p^2	$\Pi(1) = 9$
1	$2p(1 - p)$	$\Pi(2) = -3$
0	$(1 - p)^2$	$\Pi(3) = -7$

Combining the probabilities and payoffs from the above table, we get the equation:

$$\underbrace{9p^2 - 3 \times 2p(1 - p) - 7(1 - p)^2}_{\text{Expected payoff from playing "In"}} = \underbrace{0}_{\text{Payoff from playing "Out"}}$$

$$9p^2 - 6p(1 - p) - 7(1 - 2p + p^2) = 0$$

$$8p^2 + 8p - 7 = 0$$

Solving the equation on the third line (using the formula for solving quadratic equations) yields two roots, of which one is not plausible since it is not between zero and one. Thus, in the symmetric Nash equilibrium, p is $(3\sqrt{2} - 2)/4 \approx 0.56$. The probability of playing "In" for an individual firm is then approximately $1 - 0.56 = 0.44$. The probability of all three staying in is $(1 - p)^3 \approx 0.08$. Expected profits for all firms are zero.

Once again, free entry and free exit drive expected profits to zero. Probabilistic entry and exit remove even those expected profits that might survive in some markets due to the integer constraint.

75. (a) With two players and only one year left, we can represent the game with the payoff matrix:

		2	
		Stay	Exit
1	Stay	-10, -10	40, 0
	Exit	0, 40	0, 0

There are two pure strategy Nash equilibria in this game, {Stay, Exit} and {Exit, Stay}, as neither player can profitably deviate from those states unilaterally. There is also a mixed strategy Nash equilibrium, where both firms exit with some probability. Since the game is symmetric, the probability will be the same for both players. The probability p in the equilibrium must be such that the firms are indifferent between their pure strategies, i.e. their expected payoff from staying and exiting is the same when the other player exits with probability p . The payoff from staying is $40p + (1 - p)(-10)$ whereas the payoff from exiting is zero. The equilibrium p can thus be solved from $40p + (1 - p)(-10) = 0 \implies p = 1/5$.

- (b) In each period, the highest possible profit is made when there is a single firm in the market, and it equals $100/1 - 60 = 40$ million euros. With a discount rate of $r = 0.05$ and an infinite horizon, the industry could have a present value of profits of $40/0.05 = 800$ million euros if one of the firms exited immediately.
- (c) In the infinitely repeated version of the game, at the start of each period the highest feasible present value calculated in 75b is the payoff that the firm will receive if they

stay in the game and the other firm exits. If both they and the other firm stay, they will incur a loss of $100/2 - 60 = -10$ and move on to the next period. Note that we can start analyzing the game from any period, because any costs accumulated in the past are sunk and hence irrelevant for the players' decisions going forward, and the future always looks the same in terms of payoffs going forward. This game has two pure strategy subgame perfect equilibria: one where one firm stays in every period and the other one exits, and another where the roles are reversed. These equilibria are not symmetric, however, since the players are not using the same strategy. To find a symmetric equilibrium, we need to look for a mixed strategy one.

In a mixed strategy equilibrium a firm exits with some probability p and stays with probability $1 - p$. In a symmetric equilibrium, this probability will be the same for both firms. The equilibrium p has to make the other firm indifferent between staying and exiting - otherwise it could make a profitable deviation. When one firm exits with probability p , the other firm's payoff from staying is $800p + (1 - p)(-10 + V)$ where V is the continuation value, i.e. the expected value the firm will obtain from continuing the game (discounted by one period). Meanwhile, the payoff from exiting is 0. Notice, that since in a symmetric equilibrium both firms will be mixing, they must be indifferent between staying and exiting also in the next period. Because the payoff from exiting in the next period is zero, the expected value of staying must also be zero, otherwise the firm would not be indifferent between them. This means that in the symmetric equilibrium $V = 0$, and we can ignore the continuation value in the derivation of the equilibrium. The equilibrium p can then be solved by equalizing the payoffs from staying and exiting:

$$800p + (1 - p)(-10) = 0 \implies p = \frac{1}{81} \approx 0.012.$$

The symmetric equilibrium is one where both firms' strategy is to exit with this small probability in each period.

As firms are indifferent between staying and exiting in a mixed strategy equilibrium, it is enough to check the expected value under one of them. As the expected value from exiting is zero, so must be the expected value from staying, for both firms and for the industry. Finally, the expected present value of zero forever is clearly zero. In effect, the chance of obtaining monopoly profits in the future is in expectation exactly squandered by the delayed exit from the initially loss-making duopoly.

Side comment: there are also two asymmetric (and efficient) equilibria, where one firm exits immediately and the other stays.

76. (a) Let's call the two companies A and B. Each company has to pay 6 billion Ducats if they to participate in the contract 'lottery'. Winning the lottery, i.e., getting the contract earns the winning company 10 billion Ducats. The losing company

doesn't get anything. The winning company is faced with an additional construction cost of 2 billion Ducats. Therefore, the (expected) profit is 0 if the company does not participate in the lottery. If the company participates in the lottery and the other firm does not, the participating company always wins the lottery resulting to (expected) profit of $10 - 6 - 2 = 2$ billion Ducats. If both participate, the expected profit is $0.5 \times 0 + 0.5 \times (10 - 2) - 6 = -2$.

To summarize the expected payoffs for company $f \in \{A, B\}$:

$$\begin{aligned}\mathbb{E}[\pi_f | a = 0, b = 0] &= 0 \\ \mathbb{E}[\pi_f | a = 0, b = 1] &= 0 \\ \mathbb{E}[\pi_f | a = 1, b = 0] &= 2 \\ \mathbb{E}[\pi_f | a = 1, b = 1] &= -2\end{aligned}$$

in which π_f is the profits of company f given decision $a \in \{0, 1\}$ of company A and decision $b \in \{0, 1\}$ of company B . Here, $a, b = 1$ indicates participation of the corresponding company.

The payoff matrix is therefore

		Company B	
		0	1
Company A	0	(0, 0)	(0, 2)
	1	(2, 0)	(-2, -2)

We find two pure strategy equilibria, $(0, 1)$ and $(1, 0)$ because none of the companies can improve their payoff by changing their individual choices. There is also a mixed strategy equilibrium. Each player randomizes their decision to participate in the lottery. They participate with the same probability p because the firms are symmetrical. To find this probability the company has to make the other company's expected payoffs between the choices (participate, don't participate) the same, i.e.,

$$\begin{aligned}0(1 - p) + 0p &= 2(1 - p) + (-2)p \\ 0 &= 2 - 2p - 2p \\ 4p &= 2 \implies p = 0.5\end{aligned}$$

Therefore, each of the companies participate in the lottery with a probability of 0.5. Therefore, the probability that the bridge will be built is one minus the probability that neither company participates in the lottery: $1 - 0.5 \times 0.5 = 0.75$.

- (b) The only way to make sure that the bridge will be built by increasing the amount of Ducats awarded is to make sure that the expected value of participating is higher

than not participating even if the other company participates i.e., (1,1) becomes the pure strategy equilibrium. This happens if the payoff x satisfies

$$\begin{aligned} 0.5 \times (-6) + 0.5 \times (x - 8) &> 0 \\ -3 + 0.5x - 4 &> 0 \\ 0.5x > 7 &\implies x > 14 \end{aligned}$$

That is, the government awards 14 billion Ducats for the construction.

- (c) Now we add a third company C and its decision c . Hence, the expected profits are probability of winning times (award - construction cost) minus planning costs if the company participates. That is, the expected payoffs for company A are

$$\begin{aligned} \mathbb{E}[\pi_f | a = 0] &= 0 \\ \mathbb{E}[\pi_f | a = 1, b = 0, c = 0] &= \frac{1}{1}(10 - 2) - 6 = 2 \\ \mathbb{E}[\pi_f | a = 1, b = 1, c = 0] &= \mathbb{E}[\pi_f | a = 1, b = 0, c = 1] = \frac{1}{2}(10 - 2) - 6 = -2 \\ \mathbb{E}[\pi_f | a = 1, b = 1, c = 1] &= \frac{1}{3}(10 - 2) - 6 = -\frac{10}{3} \end{aligned}$$

Due to symmetry of the companies, the expected profits are the same for each company given the number of participants and their choice to participate or not.

Yet again, in the symmetric Nash equilibrium, the expected value of participating should be the same as the expected value of not participating. Therefore, using the binomial distribution for computing the expected payoffs

$$\begin{aligned} 0p + 0(1 - p) &= 2 \binom{2}{0} p^0 (1 - p)^2 + (-2) \binom{2}{1} p^1 (1 - p)^1 + \left(-\frac{10}{3}\right) \binom{2}{2} p^2 (1 - p)^0 \\ 0 &= 2(1 - 2p + p^2) - 4(p - p^2) - \frac{10}{3}p^2 \\ 2 - 4p + 2p^2 - 4p + 4p^2 - \frac{10}{3}p^2 &= 0 \\ \frac{8}{3}p^2 - 8p + 2 &= 0 \\ 4p^2 - 12p + 3 &= 0 \end{aligned}$$

Using the quadratic formula we find

$$\begin{aligned} p &= \frac{12 \pm \sqrt{144 - 4 \times 4 \times 3}}{2 \times 4} = \frac{12 \pm \sqrt{144 - 48}}{8} \\ p &= \frac{12 \pm 4\sqrt{6}}{8} = \frac{3 \pm \sqrt{6}}{2} \end{aligned}$$

Thus, $p \approx 0.275$ or $p \approx 2.72$ but $p \in [0, 1]$ so

$$p \approx 0.275.$$

As noted earlier, the expected equilibrium profits are zero. The probability that the bridge gets built is $1 - (1 - 0.275)^3 \approx 0.619$. The entry of an additional potential participant decreases the probability that anyone actually participates! This is an example of a more general phenomenon of a coordination friction, more of which in the following additional comment.

Additional comment: solution with any number of firms ($N \geq 2$)

Non-participation is one of the actions that the firms must be indifferent with in mixed strategy equilibrium. It gives zero profits, so expected profits must also be zero. This applies both to expected profits conditional on participating and to the unconditional expected profits from the game.

Let's see how the unconditional expected profit of a firm depends on the participation probability p in symmetric equilibrium. Expected participation cost is $6p$. If at least one firm participates then the profit net of the participation costs for the whole industry is 8. Exactly one firm gets this "prize", unless all N firms fail to participate, so the prize is earned by some firm with probability $1 - (1 - p)^N$. Firms are symmetric so each gets, in expectation, the same $1/N$ share of the expected prize in equilibrium. Expected equilibrium profits of every firm are then

$$\bar{\Pi}(p, N) = (1 - (1 - p)^N) \frac{8}{N} - 6p.$$

Equilibrium probability is the p that solves $\bar{\Pi}(p, N) = 0$. For example, with $N = 3$, the zero profit condition is (after some rearrangement) the same polynomial seen above in the "Solution with 3 firms." More generally, the zero-profit condition is a N th degree polynomial. It is straightforward to check that, $\lim_{p \rightarrow 0} \bar{\Pi}(0, N) = 0$, $\bar{\Pi}(1, N) = 8/N - 6 < 0$, and in between $\bar{\Pi}$ is concave p so, for any $N \geq 2$, the polynomial has exactly one root in $(0, 1)$. Let's denote this solution $p^*(N)$. The probability that the bridge gets built is the probability that at least one firm participates: $\Pr(\text{build}|N) = 1 - (1 - p^*(N))^N$.

Very additional comment. We already saw above that the probability of the bridge getting built is lower when there 3 rather than 2 potential participants. This result generalizes to any N (see Figure 75). The more firms there are, the more likely it is that no one shows up! This is a type of a *coordination friction*. This phenomenon is important for the design of procurement rules. High participation costs deter participation, and having more potential entrants just makes the problem worse.

While here the “winner” was chosen randomly among those who show up, this is not important for the problem. When firms compete and do not observe each others’ types, the winner will be unpredictable from their point of view and they only have some probability of winning.

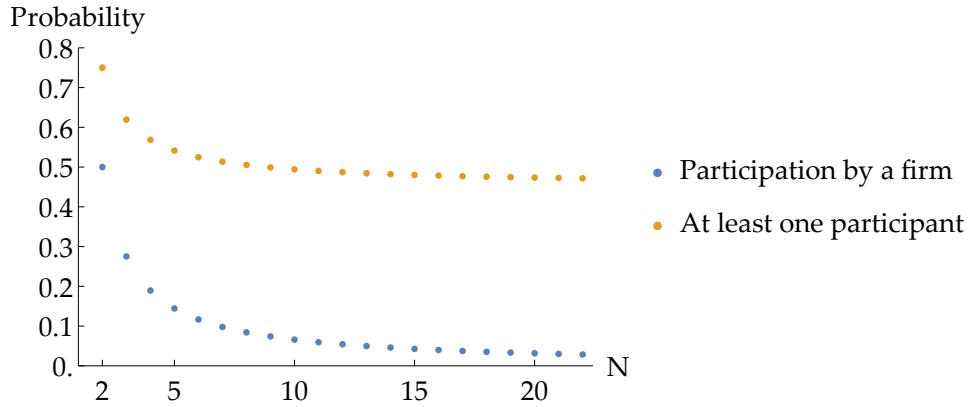

Figure 75: Mixed strategy equilibrium and number of firms N in part 76c. The bridge gets built if at least one firm participates.

Additional comment 2. Based on Figure 75 it looks like the probability that at least one firm participates converges to about 0.45 as the number of firms grows without limit. This is indeed correct even as $N \rightarrow \infty$. To show this, first let’s use this limit. In the limit the number of participants is pN . Let’s denote $pN = \lambda$.

$$\lim_{N \rightarrow \infty} 1 - \left(1 - \frac{\lambda}{N}\right)^N = 1 - e^{-\lambda}$$

Using the zero-profit condition $\bar{\Pi}(p, N)$ from above, we know that p must be such that in the limit

$$1 - e^{-\lambda} = x$$

This can be solved for

$$p^*(\infty) = 1 + \frac{C}{R} W\left(-\frac{R}{C} e^{-\frac{R}{C}}\right)$$

where W is Lambert’s W function. Plugging in $C = 8$, $R = 10$, this becomes 0.4544....

77. (a) This is a symmetric duopoly problem à la Cournot. Let’s first solve for the best response function of one of the firms. The profit function of Xenon is:

$$\begin{aligned} \Pi_X(Q_X, Q_Y) &= P^d(Q_X + Q_Y) \times Q_X - TC_X(Q_X) \\ &= (200 - 0.5(Q_X + Q_Y))Q_X - 15 - 17Q_X \end{aligned}$$

The best response function of Xenon is:

$$\frac{\partial \Pi_X(Q_X, Q_Y)}{\partial Q_X} = 183 - Q_X - 0.5Q_Y = 0 \Leftrightarrow$$

$$BR_X(Q_Y) = 183 - 0.5Q_Y$$

Since the problem is symmetric, $BR_X(Q_Y) = BR_Y(Q_X)$ and the optimal production amounts are the same ($Q_X^* = Q_Y^* = q$). So we get:

$$q = 183 - 0.5q \Rightarrow$$

$$q = 122$$

Hence, $Q_X^* = Q_Y^* = 122$. The optimal price is then $P^* = 78$. Aggregate profits are:

$$2 \times \Pi_X(Q_X^*, Q_Y^*) = 2 \times (P^* \times Q_X^* - TC(Q_X^*))$$

$$= 2 \times (78 \times 122 - 15 - 17 \times 122) = 14854 \text{ million euros}$$

The consumer surplus is $\frac{(200-P) \times (Q_X + Q_Y)}{2} = \frac{(200-78) \times (244)}{2} = 14884$ million euros. The total surplus is $14854 + 14884 = 29738$ million euros.

(b) This is a monopoly problem. Monopoly profits are:

$$\Pi_M(Q_M) = (200 - 0.5Q_M)Q_M - 16 - 17Q_M$$

$$= 183Q_M - 0.5Q_M^2 - 16$$

The optimal quantity is:

$$\frac{\partial \Pi_M(Q_M)}{\partial Q_M} = 183 - Q_M = 0 \Leftrightarrow$$

$$Q_M^* = 183$$

The optimal price is $200 - 0.5Q_M^* = 108.5$. Profits, consumer surplus and total surplus are (in million euros):

$$\Pi_M(Q_M^*) = 108.5 \times 183 - 16 - 17 \times 183 = 167278.25$$

$$CS(Q_M^*) = \frac{(200 - 108.5) \times 183}{2} = 8372.25$$

$$\Pi_M(Q_M^*) + CS(Q_M^*) = 167278.25 + 8372.25 = 25100.5$$

Profits are higher than in duopoly and consumer surplus is lower.

(c) Since only the fixed costs change, the optimal price and quantity are unchanged. However, profits and total surplus are lower by 24 million euros.

(d) With a lower marginal cost, monopoly profits are :

$$\begin{aligned}\Pi_M(Q_M) &= (200 - 0.5Q_M)Q_M - 34 - 14Q_M \\ &= 186Q_M - 0.5Q_M^2 - 34\end{aligned}$$

The optimal quantity is:

$$\begin{aligned}\frac{\partial \Pi_M(Q_M)}{\partial Q_M} &= 186 - Q_M = 0 \Leftrightarrow \\ Q_M^* &= 186\end{aligned}$$

The optimal price is $200 - 0.5Q_M^* = 107$. Profits, consumer surplus and total surplus are (in million euros):

$$\begin{aligned}\Pi_M(Q_M^*) &= 107 \times 186 - 34 - 14 \times 186 = 17264 \\ CS(Q_M^*) &= \frac{(200 - 107) \times 186}{2} = 8649 \\ \Pi_M(Q_M^*) + CS(Q_M^*) &= 17264 + 8649 = 25913\end{aligned}$$

Both profits and consumer surplus are thus higher than in 77b or 77c

78. (a) The payoff function (amount of food produced on the private lot + share of common lot production) of an individual villager is:

$$V_i(t_i, T_{-i}) = \sqrt{10 - t_i} + \frac{5\sqrt{\frac{t_i + T_{-i}}{5}}}{5} = \sqrt{10 - t_i} + \sqrt{\frac{t_i + T_{-i}}{5}}$$

- (b) Let's denote by t the time spent on a private lot. The time spent on the common lot is $50 - 5t$, since there are five private lots. The total output of food $V_v(t)$ in the village is:

$$V_v(t) = 5\sqrt{t} + 5\sqrt{\frac{50 - 5t}{5}} = 5\sqrt{t} + \sqrt{5}\sqrt{50 - 5t}$$

The optimal allocation is:

$$\begin{aligned}\frac{\partial V_v(t)}{\partial t} &= \frac{5}{2\sqrt{t}} - \frac{5\sqrt{5}}{2\sqrt{50 - 5t}} = 0 \Leftrightarrow \\ \frac{5}{2\sqrt{t}} &= \frac{5\sqrt{5}}{2\sqrt{50 - 5t}} \Leftrightarrow \\ \sqrt{50 - 5t} &= \sqrt{t}\sqrt{5} \Leftrightarrow \\ 50 - 5t &= 5t \Rightarrow t = 5\end{aligned}$$

And the total food output of the village is:

$$V_v(5) = 5\sqrt{5} + \sqrt{5}\sqrt{25} = 10\sqrt{5} \approx 22.4$$

- (c) This is a Cournot game. Let's find the best response function of villager i . Her best response is the choice of t_i that maximizes her payoff.

$$\begin{aligned}\frac{\partial V_i(t_i, T_{-i})}{\partial t_i} &= \frac{-1}{2\sqrt{10-t_i}} + \frac{1}{2\sqrt{5}\sqrt{t_i+T_{-i}}} = 0 \Leftrightarrow \\ \sqrt{10-t_i} &= \sqrt{5}\sqrt{t_i+T_{-i}} \Leftrightarrow \\ 5(t_i+T_{-i}) &= 10-t_i \Leftrightarrow \\ t_i &= BR_i(T_{-i}) = \frac{10}{6} - \frac{5}{6}T_{-i}\end{aligned}$$

Since all villagers are identical and have identical private lots, $T_{-i}^* = (n-1)t_i^*$. In addition, due to symmetry, all villagers spend the same time t on the common lot at optimum. Thus:

$$\begin{aligned}t &= BR_i((n-1)t) \Leftrightarrow t = \frac{10}{6} - \frac{5}{6}(n-1)t \Leftrightarrow \\ t &= \frac{10}{6} - \frac{5}{6}4t \Leftrightarrow \\ t^* &= \frac{5}{13}\end{aligned}$$

The total food output of the village is:

$$\begin{aligned}5 \times V_i\left(\frac{5}{13}, 4\frac{5}{13}\right) &= 5 \times \left(\sqrt{10 - \frac{5}{13}} + \sqrt{\frac{5 \cdot 5}{13}}\right) \\ &= 5 \times \left(\sqrt{10 - \frac{5}{13}} + \sqrt{\frac{5}{13}}\right) \approx 5 \times (3.10 + 0.62) \approx 18.6\end{aligned}$$

79. (a) Let's formulate the payoff function for OneGulp and derive its best-response function (since the firms are identical, the payoff and best-response functions for TwoSips are identical). Denoting OneGulp's price by p_1 its payoff function is:

$$\begin{aligned}\Pi_1(p_1, p_2) &= (p_1 - MC)Q_1(p_1, p_2) \\ &= (p_1 - 5)(20 - 2p_1 + p_2) \\ &= -2p_1^2 + 30p_1 + p_1p_2 - 5p_2 - 100\end{aligned}$$

To find the best-response function, let's differentiate the payoff function wrt. p_1 and find the root:

$$\begin{aligned}\frac{\Pi_1(p_1, p_2)}{\partial p_1} &= 20 - 4p_1 + p_2 + 10 = 0 \\ \implies BR_1(p_2) &= \frac{30 + p_2}{4}\end{aligned}$$

Since the problem is symmetric, $BR(p) = (30+p)/4$ and we know that in equilibrium, $p_1^* = p_2^* = p^*$. Then the equilibrium price is solved from:

$$p = BR(p) \implies p = \frac{30+p}{4} \implies p^* = 10.$$

As both firms charge the equilibrium price 10 €/l, they both sell $Q_i(p^*, p^*) = 20 - 2 \times 10 + 10 = 10$ thousand litres. Equilibrium profit per firm is then $\Pi_i(p, p) = 10 \times 10 - 5 \times 10 = 50$ thousand euros.

- (b) Let's solve for the profits of the first-mover by substituting the second-mover's best-response function into the first-mover's payoff function:

$$\begin{aligned}\Pi_1(p_1) &= (p_1 - 5)(20 - 2p_1 + \text{BR}(p_1)) \\ &= (p_1 - 5)\left(20 - 2p_1 + \frac{30 + p_1}{4}\right) \\ &= -\frac{7}{4}p_1^2 + \frac{145}{4}p_1 - \frac{550}{4}\end{aligned}$$

where the subscripts $i = 1, 2$ now denote the order of moves (which TwoSips gets to choose, but we don't know its choice yet!).

Let's differentiate wrt. p_1 to get the optimal price for the first-mover:

$$\begin{aligned}\frac{\Pi_1(p_1)}{\partial p_1} &= -\frac{14}{4}p_1 + \frac{145}{4} = 0 \implies \\ p_1^* &= \frac{580}{56} \approx 10.36 \text{ €/l}\end{aligned}$$

The second-mover will use its best response and charge

$$p_2^* = \text{BR}_2(p_1^*) = \frac{30 + 580/56}{4} = \frac{565}{4} \approx 10.09 \text{ €/l}.$$

The resulting quantities are

$$\begin{aligned}\text{First-mover: } Q_1^*(p_1^*, p_2^*) &= 20 - 2 \times \frac{580}{56} + \frac{565}{56} = \frac{75}{8} = 9.375 \\ \text{Second-mover: } Q_2^*(p_1^*, p_2^*) &= 20 - 2 \times \frac{565}{56} + \frac{580}{56} = \frac{285}{28} \approx 10.18\end{aligned}$$

and profits

$$\begin{aligned}\text{First-mover: } \Pi_1^*(p_1^*, p_2^*) &= \left(\frac{580}{56} - 5\right) \times \frac{75}{8} \approx 50.22 \\ \text{Second-mover: } \Pi_2^*(p_1^*, p_2^*) &= \left(\frac{565}{56} - 5\right) \times \frac{285}{28} \approx 51.80\end{aligned}$$

Profits are higher for the second-mover, so TwoSips should commit to a price only after OneGulp has already done so.

- (c) The marginal cost of production has increased for TwoSips so we need to solve for its new best-response function by the same steps as in problem 79a:

$$\Pi_2(p_1, p_2) = (p_2 - 6.5)(20 - 2p_2 + p_1)$$

The best-response function:

$$\frac{\Pi_2(p_1, p_2)}{\partial p_2} = 20 - 4p_2 + p_1 + 13 = 0$$

$$\implies BR_2(p_1) = \frac{33 + p_1}{4}$$

OneGulp knows about the increase in TwoSips' marginal cost, but the game is no longer symmetric. The Nash equilibrium condition that both players are using their best responses simultaneously can no longer be reduced to just one equation. Instead we have a system of two equations and two unknowns: $p_1 = BR_1(p_2)$ and $p_2 = BR_2(p_1)$. Plugging in the solved best responses from before,

$$p_1 = \frac{30 + p_2}{4}$$

$$p_2 = \frac{33 + p_1}{4}$$

The solution is $p_1^* = 10.20$, $p_2^* = 10.80$. OneGulp's profits are

$$\Pi_1(p_1^*, p_2^*) = (10.20 - 5) \times (20 - 2 \times 10.20 + 10.80) = 54.08 \text{ €k.}$$

TwoSips' problems cause OneGulp also to increase its price (although by less than TwoSips' price hike). As a result OneGulp's profits go up by about 4.1 €k.

80. (a) We can solve for the p^* that maximizes joint profits by thinking as if the pricing decision was made by a profit-maximizing monopoly. The demand it would face is the sum of the demands of both firms. Since the problem is symmetric, we know that $p_1^* = p_2^* = p^*$.

$$Q^D(p) = Q_1(p, p) + Q_2(p, p) = 2 \times (20 - 2p + p) = 40 - 2p$$

Let's then formulate the profit function:

$$\begin{aligned} \Pi(p) &= Q^D(p)(p - MC) \\ &= (40 - 2p)(p - 5) \end{aligned}$$

And differentiate wrt. p to get the optimal collusion price p^* :

$$\frac{\partial \Pi(p)}{\partial p} = 40 - 4p + 10 = 0$$

$$\implies p^* = 12.5 \text{ €/l}$$

- (b) We know that the Nash equilibrium price is the same that we solved for the stage-game in PS 6.4a, $p^N = 10$. Let's then solve for p^C from the best-response function we solved in PS 6.4a:

$$\begin{aligned} BR_1(p^*) &= \frac{30 + p^*}{4} = \frac{30 + 12.5}{4} \\ &= 10.625 \text{ €/l} \end{aligned}$$

Now that we have the three prices, let's calculate the payoffs of different price combinations for OneGulp (by symmetry, they will be the same for TwoSips) by using the payoff function from PS 6.4a:

p_1	p_2	$\Pi(p_1, p_2) = (p_1 - MC)Q_1(p_1, p_2)$
10	10	$(10 - 5)(20 - 20 + 10) = 50 \text{ €k}$
10	10.625	$(10 - 5)(20 - 20 + 10.625) \approx 53 \text{ €k}$
10	12.5	$(10 - 5)(20 - 20 + 12.5) \approx 63 \text{ €k}$
10.625	10	$(10.625 - 5)(20 - 21.25 + 10) \approx 49 \text{ €k}$
10.625	10.625	$(10.625 - 5)(20 - 21.25 + 10.625) \approx 53 \text{ €k}$
10.625	12.5	$(10.625 - 5)(20 - 21.25 + 12.5) \approx 63 \text{ €k}$
12.5	10	$(12.5 - 5)(20 - 25 + 10) \approx 38 \text{ €k}$
12.5	10.625	$(12.5 - 5)(20 - 25 + 10.625) \approx 42 \text{ €k}$
12.5	12.5	$(12.5 - 5)(20 - 25 + 12.5) \approx 56 \text{ €k}$

The payoff matrix becomes:

		TwoSips		
		€k	P^N	P^C
OneGulp	P^N	50,50	53,49	63,38
	P^C	49,53	53,53	63,42
	P^*	38,63	42,63	56,56

- (c) The best chance for sustaining collusion is the Grim strategy, where a player colludes as long as the other player colludes but switches to playing "the stage-game Nash" for forever if the other player ever deviates from the collusion price. The "punishment" action is to choose P^N , the collusion action is to choose P^* and the "cheating" action is to choose P^C . There are three relevant payoffs: $\Pi^N = 50$, $\Pi^* = 56$ and $\Pi^C = 63$. We need to check that no player has an incentive to deviate from either the punishment state $\{P^N, P^N\}$ or the collusion state $\{P^*, P^*\}$. We know that no player has an incentive to deviate from the punishment state, because it is the stage-game Nash equilibrium. So we only need to verify that a player doesn't have an incentive to deviate from the collusion state.

$$\underbrace{56 + \frac{56}{0.05}}_{\text{Present value of cooperating}} \geq \underbrace{63 + \frac{50}{0.05}}_{\text{Present value of cheating}}$$

$$1176 \text{ €k} \geq 1063 \text{ €k}$$

This verifies that collusion can be sustained with $r = 5\%$.

(d) Let's solve for the highest r that makes collusion sustainable:

$$\begin{aligned} 56 + \frac{56}{r} &\geq 63 + \frac{50}{r} \\ \frac{6}{r} &\geq 7 \\ r &\leq \frac{6}{7} \approx 86\% \end{aligned}$$

When r is below 86 %, collusion is sustainable.

81. (a) A way to have an equilibrium where firms moderate their advertising spending to zero is to use the “Grim strategy” and choose marketing level $x = 0$ as long as the competitor chooses the same and otherwise choose $x = 25$. The payoff for Acme with $r = 0.1$ are:

$$\Pi_A(\text{Grim}, \text{Grim}) = 50 + \frac{50}{r} = 550$$

Would Acme benefit from “cheating” and setting Mid marketing level?

$$\Pi_A(\text{Cheat}, \text{Grim}) = 75 + \frac{25}{r} = 325$$

Since cheating leads to a lower payoff, {Grim,Grim} indeed is an equilibrium in this repeated game.

- (b) Now, a firm has to commit to a certain level of advertising spending for a period of t years at a time. For $t > 1$, this increases the profitability of cheating. The present value of cheating for the commitment period of length t is:

$$\sum_{k=0}^{t-1} 75B^k = \frac{75(1 - B^t)}{1 - B}, \text{ by geometric series formulas}$$

Where $B = (1 + r)^{-1}$. Similarly, the present value after the commitment period, when cheating is revealed and both players start playing the one-time game Nash-equilibrium strategy, is:

$$\sum_{k=t}^{\infty} 25B^k = \frac{25B^t}{1 - B}$$

Let's solve for period length t above which the payoff from cheating is higher than the {Grim,Grim} payoff 550 solved in 81a:

$$\begin{aligned} \frac{75(1 - B^t)}{1 - B} + \frac{25B^t}{1 - B} &> 550 \\ 75(1 - B^t) + 25B^t &> 550(1 - B) \\ 75 - 50B^t &> 50 \\ B^t &> \frac{1}{2} \\ t \ln B &> \ln\left(\frac{1}{2}\right) \\ t &> \frac{\ln\left(\frac{1}{2}\right)}{\ln\left(\frac{10}{11}\right)} \approx 7.3 \text{ years} \end{aligned}$$

Thus, spending moderation can be sustained if the period length is at most 7 years.

82. (a) Recall the payoff matrix from 6.1a but with the action 6 no longer available.

		B		
		0	2	4
A	0	0, 0	0, 336	0, 288
	2	336, 0	168, 168	112, 192
	4	288, 0	192, 112	144, 144

A finitely repeated game can be solved by backwards induction. We know from 6.1a that the one-shot game has a single Nash equilibrium, $\{4,4\}$ (since $\{6,6\}$ is no longer available). That is the subgame perfect Nash equilibrium (SPNE) in the last period, hence also in the second to last period, etc. Thus in the SPNE both players always choose to pick chanterelles at 4 l/h.

Additional intuition. The total possible payoffs for both players in period 5 consist of the payoffs from the above matrix plus some constant, which represents the sum of their payoffs from previous periods. However, the important point is that they can't affect the constant with their choices in the last period, and the constant is the same for all states, so only the above matrix matters, and the same reasoning as in 69a applies. There is a single Nash equilibrium, $\{4,4\}$, in each of the last-period subgames (note that there are many of these: one per each possible history of choices leading up to that point). Going back to period 4, we have almost the same situation, except now there is also a continuation value (the value the players will gain from period 5) associated with each state the players might end up in. However, we already know that what happens in period 5 in a SPNE does not depend on what the players have done prior to that - the continuation value will be the same regardless of what is done in this period. Hence, the above matrix is again all that matters for the player's choices. This same logic can be repeated going back one period at a time all the way back to the first period - any possibility of

cooperation unravels because the players know that they will not cooperate in the last period, so there's no incentive to cooperate in the period before that, so they also shouldn't cooperate in the period before that etc.

- (b) Backwards induction is not possible in a game without a known final period. This opens up opportunities for cooperation, as a threat of lost benefits of future cooperation can be used to enforce cooperation in the present. We saw in 69a that the best outcome for the players comes from playing $\{2,2\}$, which results in a period payoff of $V^* = 168$ for both. This is the cooperative or socially efficient payoff, but is not a Nash equilibrium. The Nash equilibrium $\{4,4\}$ results in $V^0 = 144$ for both. And a player that "cheats" by deviating from the cooperative outcome obtains $V^c = 192$. The strongest possible "punishment" is meted out by the Grim trigger strategy, where a player starts by cooperating (here: choose 2), but any deviation by the other player will result in a permanent switch to playing the Nash equilibrium strategy (choose 4). Form $\{\text{Grim}, \text{Grim}\}$ to be an equilibrium it must yield a higher present value than cheating followed by Nash equilibrium forever after. If both play Grim then, using the perpetuity formula, and denoting the discount factor $B = 1/(1+r)$, the present value of a player is

$$\Pi^* = 168 + 168B + 168B^2 + \dots = 168 + \frac{168}{r} = 168 + \frac{168}{0.1} = 1848.$$

A cheater would get V^c in the first period and then V^0 forever after, resulting in present value

$$\Pi^c = 192 + 144B + 144B^2 + \dots = 192 + \frac{144}{r} = 1632.$$

As cheating against Grim strategy is not attractive if done in the first period, it cannot improve PV later either.

- (c) Now Alice and Bernard will get the same payoff as in parts 82a and 82b, but with only 50% probability, and a payoff of 0 with 50% probability. This does not change any comparison between strategies, as all payoffs are effectively cut in half. Equilibrium strategies are not affected.
- (d) Now that Bernard is the less patient player, his patience will be the limiting factor on the ability to sustain cooperation. For Bernard to not be too tempted by the immediate payoff from cheating, his present value from cheating must not exceed the PV from permanent cooperation. Let's use the PV formulas from 82b but leave in the discount rate r as an unknown. To ensure that the PV from cheating does not exceed the PV from $\{\text{Grim}, \text{Grim}\}$ we need

$$168 + \frac{168}{r} > 192 + \frac{144}{r},$$

from which we can solve r as the unknown: $r < 1$. This means that as long as Bertrand's discount rate does not exceed 100% cooperation can be sustained indefinitely.

83. (a) Customers gain a benefit of 10 by paying p plus the distance cost $5d$. The customers problem is:

$$\begin{aligned} 10 &> 5d + p \\ d &< \frac{10 - p}{5} \end{aligned}$$

Because the gelato shop is located in the centre, it gets 10000 customers/km from both directions. The demand for the gelato shop (in 10000 liters) is therefore $q = 2 \times (10 - p)/5$. The profits (in €10000) are:

$$\begin{aligned} \pi &= qp - 4q - 2.5 = 2 \times \frac{10 - p}{5}p - 8 \times \frac{10 - p}{5} - 2.5 \\ &= 4p - \frac{2}{5}p^2 - 16 + \frac{8}{5}p - 2.5 \\ &= -\frac{2}{5}p^2 + \frac{28}{5}p - 4.1 \end{aligned}$$

The gelato shop maximizes wrt to p :

$$\begin{aligned} \frac{\partial \pi}{\partial p} &= -\frac{4}{5}p + 28/5 = 0 \\ p^* &= 7 \end{aligned}$$

It attracts customers from distances closer than $d < (10 - 7)/5 = 3/5 = 600\text{m}$ from either side.

- (b) In the margin, gelato shops cannot make a profit, otherwise a new one would enter the market.

$$\begin{aligned} \pi &= 7q - 4q - 2.5 = 0 \\ q &= 5/6 = 0.83 \end{aligned}$$

In other words, each gelato shop will attract customers from a 0.83km stretch. This corresponds to $10/0.83 = 12$ gelato shops in the equilibrium.

- (c) Now the marginal customer d km away from the gelato shop compares his surplus relative to the gelato shop on his other side:

$$\begin{aligned} 10 - 5 \times (0.83 - d) - 7 &< 10 - 5d - p \\ d &< 67/60 - 0.1p \end{aligned}$$

Proceeding as before, $q = 2 \times (67/60 - 0.1p)$ and the profits are:

$$\pi = qp - 4q - 2.5 = 2 \times (67/60 - 0.1p)p - 8 \times (67/60 - 0.1p) - 2.5$$

The gelato shop maximizes wrt to p : $\partial\pi/\partial p = 0 \implies p^* = 7.58$. The gelato shop would gain from slightly increasing its price.

84. (a) Since the price of drugs is the same in both pharmacies (10 euros), customers will simply choose the pharmacy that is closest to them.

How should the pharmacies place themselves? Let's imagine that they will be situated at both ends of the avenue, A at 0 km and B at 1 km. Then, customers would be split equally between the pharmacies. However, pharmacy A could improve its position by moving towards the middle to A km, since then it would get all the customers from the interval $[0,A]$ and half of the customers from the interval $[A,B]$. Likewise, B could improve its position by moving towards the middle.

In equilibrium, both pharmacies' location decision is a best response to the other pharmacy's strategy. Pharmacies can improve their position relative to the competitor until they reach the midpoint of the avenue. $\{0.5,0.5\}$ is the unique equilibrium of the game. Neither of the pharmacies can be better off by moving away from this position, as long as the other pharmacy stays at this position. Both pharmacies get half of the customers and earn $\pi_A = \pi_B = (10 - 5) \times (100k/2) = 250k$ euros.

- (b) The total profits in the market are $\text{€}5 \times 100k = \text{€}500k$. The number of firms N is such that no further entrant would find it profitable to enter:

$$\begin{aligned} 120N &> 500 \\ N &> \frac{500}{120} \\ N &> \frac{25}{6} > 4 \end{aligned}$$

There will thus be 4 pharmacies. A symmetric equilibrium, where the distance between each neighboring pair of pharmacies is the same, is for example at $\{0.125, 0.375, 0.625, 0.875\}$ kilometers along the 1-kilometer avenue.

In this example, there are also other possible equilibria that fulfill the criteria given in the exercise, such as $\{0.130, 0.380, 0.630, 0.880\}$.

- (c) If a customer is situated so that $p_A + 10(x_A - x_i)^2 < p_B + 10(x_B - x_i)^2$, she will choose pharmacy A. Let's define an indifferent customer, who is at such a distance

from the pharmacies that she is indifferent between them at prices p_A and p_B :

$$\begin{aligned} p_A + 10(x_A - x_i)^2 &= p_B + 10(x_B - x_i)^2 \\ p_A + 10(0.25 - x_i)^2 &= p_B + 10(0.75 - x_i)^2 \\ 10x_i + p_A - p_B - 5 &= 0 \\ x_i &= \frac{5 - p_A + p_B}{10} \end{aligned}$$

Pharmacy A will get the share of customers who are situated closer to zero than the indifferent customer, which is equal to x_i .

The profits of pharmacy A per customer are:

$$\begin{aligned} \pi_A(p_A, p_B) &= (p_A - 5)x_i \\ &= (p_A - 5) \frac{5 - p_A + p_B}{10} \end{aligned}$$

A's best response as a function of p_B is found by maximizing the profit function with respect to p_A :

$$\begin{aligned} \frac{\partial \pi_A}{\partial p_A} &= (10 - 2p_A + p_B)/10 = 0 \\ 2p_A &= p_B + 10 \\ p_A &= 0.5p_B + 5 \end{aligned}$$

Since the situation is symmetric to B, its reaction function is $p_B = 0.5p_A + 5$.

In equilibrium, both pharmacies play their best responses. Since the situation is symmetric, we get $p = 0.5p + 5 \Leftrightarrow p^* = p_A^* = p_B^* = 10$.

Since the prices are the same as in 84a, but the average distance to the pharmacy is shorter, consumer surplus is higher. Profits per firm are 250 000 euros, as before.

Would A benefit from changing its location, if that was possible? Let's see what would happen if A relocated itself at 0 km (any example of moving towards zero will suffice as an answer). In this case, the indifferent customer would be at:

$$\begin{aligned} p_A + 10(0 - x_i)^2 &= p_B + 10(0.75 - x_i)^2 \\ p_A + 10x_i^2 &= p_B + 10(0.75 - x_i)^2 \\ p_A - p_B + 15x_i - 5.625 &= 0 \\ x_i &= \frac{5.625 - p_A + p_B}{15} \end{aligned}$$

This is equal to the share of customers choosing pharmacy A. Pharmacy B's profits per customer would be:

$$\begin{aligned} \pi_B(p_A, p_B) &= (p_B - 5)(1 - x_i) \\ &= (p_B - 5) \left(1 - \frac{5.625 - p_A + p_B}{15}\right) \end{aligned}$$

and the best response function:

$$\frac{\partial \pi_B}{\partial p_B} = -0.133(-7.1875 + p_B - 0.5p_A) = 0$$

$$\implies p_B = 0.5p_A + 7.1875$$

Let's plug B's best response function into A's profit function and maximize with respect to price:

$$\begin{aligned} \pi_A(p_A, p_B) &= (p_A - 5) \times \frac{5.625 - p_A + p_B}{15} \\ &= (p_A - 5) \times \frac{5.625 - p_A + 0.5p_A + 7.1875}{15} \end{aligned}$$

$$\frac{\partial \pi_A}{\partial p_A} = 1.02083 - 0.067p_A = 0$$

$$p_A \approx 15.312$$

Then $p_B = 14.844$. A's profit is thus $\pi_A(p_A, p_B) \times 100k \approx 355k$ euros.

This is greater than the profit at location 0.25 km. A would benefit from relocation. In this case, the location decision is a form of product differentiation: when the price is not fixed the firms benefit from moving away from each other (at least to an extent).

85. (a) Since BonkWings is a monopolist, we simply need to compare the daily profits between the small and the large plane. Let's first invert the demand function to express profits as a function of quantity:

$$Q^D(p) = 200 - 10p \Leftrightarrow P^D(q) = 20 - \frac{q}{10}$$

Let's then formulate the profit function of BonkWings:

$$\Pi(q) = q \times \left(20 - \frac{q}{10}\right) - FC_{\text{plane}}$$

And calculate profits for both plane sizes at maximum capacity:

$$\begin{aligned} \text{Small plane: } \Pi(60) &= 60 \times \left(20 - \frac{60}{10}\right) - 300 = 540 \\ \text{Large plane: } \Pi(100) &= 100 \times \left(20 - \frac{100}{10}\right) - 500 = 500 \end{aligned}$$

We also need to verify that flying a plane full would be the profit-maximizing decision for BonkWings for both plane sizes. This is done by calculating the marginal revenue of BonkWings at maximum capacity.

The marginal revenue function is:

$$MR(q) = \frac{\partial \Pi(q)}{\partial q} = 20 - \frac{q}{5}$$

Let's then calculate the marginal revenue for the small and the large plane at maximum capacities:

$$\text{Small plane : } MR(60) = 20 - \frac{60}{5} = 8$$

$$\text{Large plane : } MR(100) = 20 - \frac{100}{5} = 0$$

Since marginal revenue is non-negative for both, it makes sense to fly both the small and the large plane full. The small plane is the profit-maximizing choice when BonkWings is a monopolist. The number of trips is 60 per day and the ticket price is $P^D(60) = 20 - \frac{60}{10} = 14$ MUs.

- (b) Since BonkWings makes its operation decision (plane size) before AcmeAir, this is a sequential game. BonkWings can choose a large plane (L) or a small plane (S) and AcmeAir has three options: a large plane, a small plane or to stay out of the market altogether.

The market price is defined by the combined capacity of both airlines. For example, if BonkWings chooses a large plane and AcmeAir a small plane, the market price is $P^D(100 + 60) = 20 - \frac{100+60}{10} = 4$ MUs and the daily profits for the firms $\Pi_{Bonk}(100, 60) = 100 \times 4 - 500 = -100$ MUs and $\Pi_{Acme}(100, 60) = 60 \times 4 - 300 = -60$ MUs.

By calculating all the possible profit combinations, we can construct the following game tree, where *L*, *S* and *Out* are the plane size decisions and the numbers at the end nodes are the corresponding daily profits for both firms (BonkWings' profits on the left, AcmeAir's on the right)

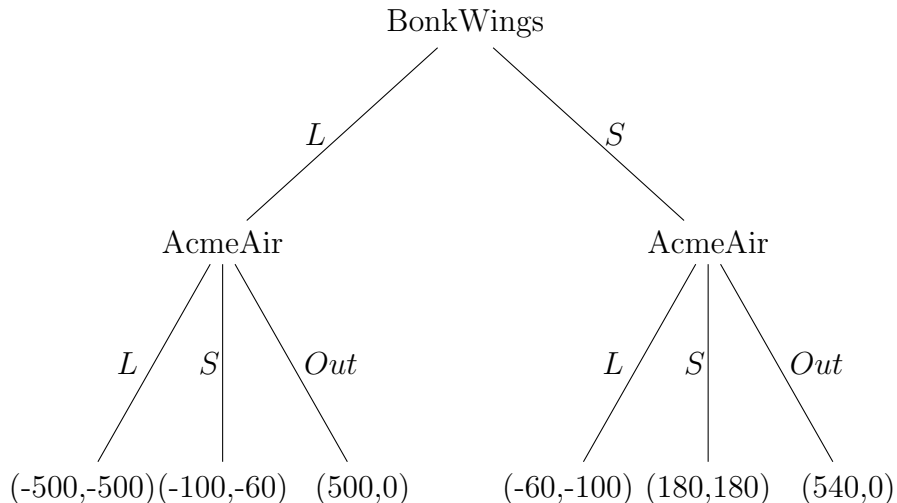

This is a sequential game that can be solved with backwards induction. In the subgame perfect Nash equilibrium, BonkWings chooses a large plane and AcmeAir stays out of the route. The quantity of trips is 100 per day and the ticket price is 10 MUs.

86. (a) This is a Hotelling line problem, where prices are fixed so airlines only choose their departure times while passengers fly with the airline that departs closest to their preferred time. Let's denote the departure time by $t \in \{0, 40\}$, where the 08:00 departure time is $t = 0$ and the last departure time 18:00 is $t = 40$. The consumer surplus for a passenger whose preferred timing is i is $CS_i = 400 - 10 \times |i - t| - 200$ dollars. This means that if the departure time differs from consumer i 's preferred departure time by more than 20 time units (or five hours), she will choose not to fly. Note that in this market, it is profitable to serve all customers since the additional revenue from a second flight is $300 \text{ passengers} \times 200 \text{ dollars per ticket} = \$60\,000$ which exceeds the fixed cost of another flight. It is efficient to serve all customers because all 800 potential passengers get a positive consumer surplus.

In equilibrium, AcmeAir (A) locates at $t = 20$ and BonkWings (B) either at $t = 19$ or $t = 21$, which is shown graphically below. If A places somewhere else than in the middle, B will want to locate in the middle and that would leave A with fewer passengers. B's best response to A locating in the middle is to locate as close to the middle as possible. The red line shows the share of customers that choose A and the blue line those that choose B.

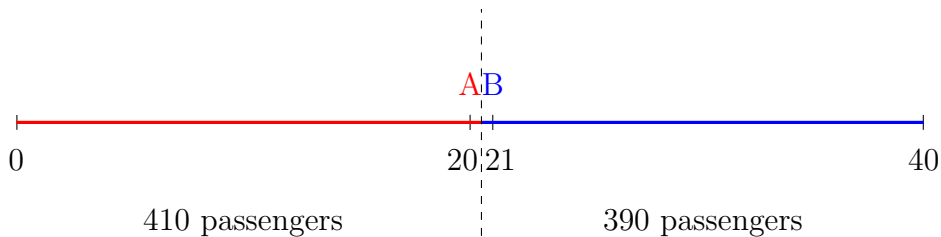

The profits of the airlines are:

$$\Pi_A(t_A = 20, t_B = 21) = 410 \times 200 - 40\,000 = \$42\,000$$

$$\Pi_B(t_A = 20, t_B = 21) = 390 \times 200 - 40\,000 = \$38\,000$$

To see why A wants to locate in the middle, let's consider a case where A would locate at $t = 0$. In this case, B would choose its position so that it gets the maximum capacity of 500 passengers, which is achieved by locating eg. at $t = 20$.

A could thus improve by moving towards the middle. If A chooses for example $t = 10$, it will get more passengers than by locating at $t = 0$. B would still want to locate in the middle and would get more passengers than A.

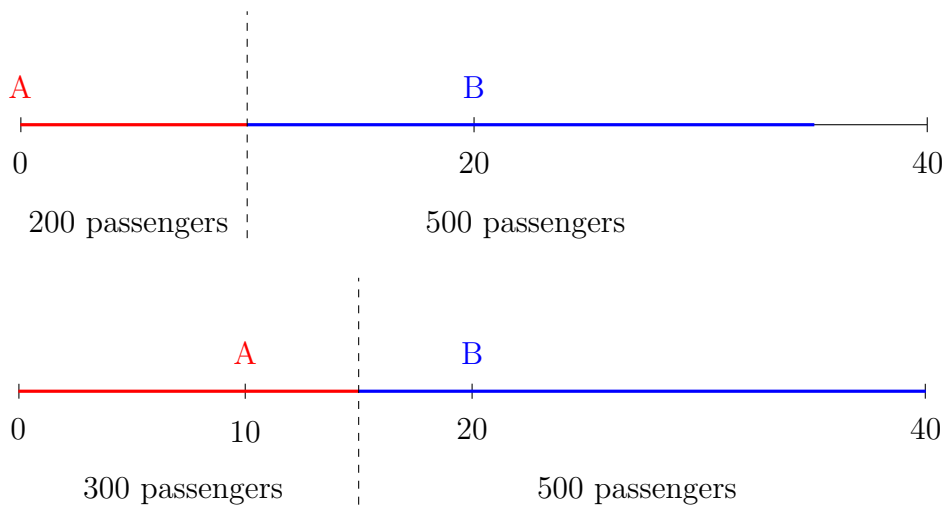

- (b) The total revenues to be earned in the market are $800 \times 200 = \$160\,000$. Since the fixed cost is $\$40,000$, there can be at most four flights departing in the market. Let's solve the exercise by guessing a potential equilibrium schedule and verifying that it indeed is an equilibrium. An obvious candidate is a symmetric equilibrium where the distance between each neighbouring flight is the same. One such equilibrium is to have A's flights located at $t = 5$ and $t = 25$ and B's flights at $t = 15$ and $t = 35$. All flights would get 200 passengers and earn zero profits. This is an equilibrium, since neither of the firms can increase its profits by increasing or decreasing its amount of flights.

There are also many other equilibria. In one such equilibrium, A has two flights at $t = 5$ and $t = 35$ and B one flight at $t = 20$

- (c) Maximal profits are earned with a schedule that has two flights and that covers the whole market. This is accomplished for example with a schedule that has flights at $t = 10$ and $t = 30$. Profits are $800 \times 200 - 2 \times 40\,000 = \$80\,000$. It is not profitable to increase the number of flights, since it would not bring any additional passengers.
- (d) In a social optimum, flights need to be scheduled so that the average distance from preferred departure times is minimized. With two flights, this is achieved with flights at $t = 10$ and $t = 30$, resulting in an average waiting time of 5 time units. The total surplus (TS) is:

$$\begin{aligned} TS(2 \text{ flights}) &= CS(2 \text{ flights}) + \Pi(2 \text{ flights}) \\ &= 800 \times (400 - 10 \times 5 - 200) + 80\,000 = \$200\,000 \end{aligned}$$

Having three flights placed optimally would decrease the average waiting time to $3\frac{1}{3}$ time units. Saving on average $5 - 3\frac{1}{3} = 1\frac{2}{3}$ time units of waiting would increase consumer surplus by $800 \times 10 \times 1\frac{2}{3} \approx \$13\,300$, which is less than the increase in fixed costs. Thus, $\{t = 10, t = 30\}$ is the optimum.

87. (a) If both vendors charge the same amount for their ice cream, the consumers will choose the vendor closest to them (or not buy anything at all). Suppose a customer is located at the western end. Their cost of shopping at Abholos is $3 \times 0.5 + 2 = 3.5$, which is less than their reservation value, so Abholos will get all the customers from the western end, giving it a profit of $300 \times (2 - 1) = 300$. A customer at the eastern end, meanwhile, has a cost of shopping at Bokrug of $4 \times 0.5 + 2 = 4$, which is still less than their reservation value, so Bokrug will get all the customers from the eastern end at a profit of $400 \times (2 - 1) = 400$. Clearly, everyone on the 300 meters of beach between Abholos and Bokrug will also want ice cream (their distance to the closest vendor is shorter than at either border). The customers are split in half, yielding each vendor a further $150 \times (2 - 1) = 150$ in profit. Abholos' total profit is then $300 + 150 = 450$ and Bokrug's $400 + 150 = 550$.

Consumer surplus is depicted in Figure 76, where the blue line represents the consumer surplus of shopping at Abholos and the red line the consumer surplus of shopping at Bokrug for the customers located on the beach at a point on the horizontal axis. The customer at the western end of the beach, for example, gets consumer surplus of $5 - 3 \times 0.5 - 2 = 1.5$ by shopping at Abholos. At every location customers choose what gives them the highest surplus, so total consumer surplus is represented by the area under the blue curve up to 450 meters (0.45 km) plus the area under the red curve from that point on.

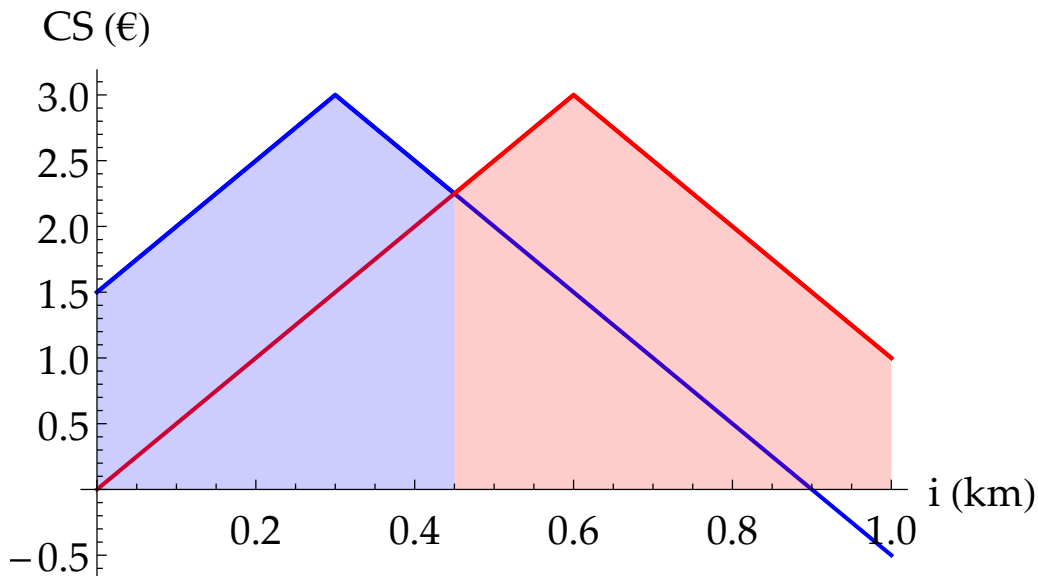

Figure 76: Consumer surplus at Shell Beach. Blue curve depicts the CS of a consumer located at i if they were to buy from Abholos, red curve if they buy from Bokrug, while both are charging €2.

(b) Note that Abholos will not lose any customers by locating somewhere between where it currently is and where Bokrug is: if both vendors were located where Bokrug is,

consumer surplus would still be at least zero even at the western border of the beach—since $6 \times 0.5 + 2 = 5$ —and as long as Abholos is to the west of Bokrug, customers on its west side will choose it. (By the definition of a reservation price, a consumer who gets 0 surplus still buys the product.) Meanwhile, any customers between Abholos and Bokrug will always be split evenly between them. Hence, with each meter Abholos moves towards Bokrug, it will gain customers from east and not lose anyone from west. This means that Abholos should locate right next to Bokrug on the western side, yielding it a profit of $599 \times (2 - 1) = 599$. (Locating on the eastern side of Bokrug would cut its profits to below what Bokrug earns in 87a, because it would lose all west-side customers, so it is not profitable.)

- (c) Let p denote Bokrug's price, while Abholos price is fixed at 2. Notice first from Figure 76 that in order to capture customers on the west side of Abholos, Bokrug would need to set its price low enough that consumer surplus at the western border rises above 1.5. This would happen when $5 - (6 \times 0.5 + p) > 1.5 \implies p < 0.5$, which, since the marginal cost of ice cream is 1, is clearly not profitable for Bokrug. Hence, we can rule out Bokrug trying to capture all customers.

Consider then the customers located between Abholos and Bokrug. Let x be the distance in hundreds of meters a customer is located from Bokrug on its western side. The customer will choose Bokrug if $0.5x + p < 0.5(3 - x) + 2 \implies p < 3.5 - x \implies x < 3.5 - p$. Hence the length of beach Bokrug controls on its west side at price $p < 3.5$ is $3.5 - p$ hundred meters, and its west-side profit $(p - 1)(3.5 - p) = 4.5p - p^2 - 3.5$ hundred euros. When $p > 3.5$, Bokrug loses all of its customers to Abholos. At exactly $p = 3.5$ Bokrug and Abholos would split the customers to the east of Bokrug, but this can not be profit-maximizing for Bokrug, since a one cent price reduction would roughly double its sales.

Next, notice from Figure 76 that Bokrug will not lose any customers from its eastern side until consumer surplus on the eastern border of Shell Beach drops below zero, which will happen when $4 \times 0.5 + p = 5 \implies p = 3$. Hence Bokrug's profit from its eastern side is $4(p - 1)$ hundred euros when $p \leq 3$.

Finally, let y stand for the distance in hundreds of meters that a customer is located from Bokrug on its eastern side. The customer will still shop at Bokrug if $0.5y + p < 5 \implies p < 5 - 0.5y \implies y < 10 - 2p$. Hence the length of beach Bokrug controls on its east side at price $p \in [3, 3.5]$ is $10 - 2p$ hundred meters and its east-side profit $(p - 1)(10 - 2p) = 12p - 2p^2 - 10$ hundred euros. With these pieces, we can construct Bokrug's profit function (ignoring the obviously unprofitable case of charging below

marginal cost, $p < 1$) can be written in hundreds of euros as:

$$\Pi_B(p) = \begin{cases} 4.5p - p^2 - 3.5 + 4(p - 1) & \text{if } p \in [1, 3) \\ 4.5p - p^2 - 3.5 + 12p - 2p^2 - 10 & \text{if } p \in [3, 3.5) \\ 0 & \text{if } p \geq 3.5 \end{cases}$$

When $p \in (1, 3)$ Bokrug's profits are increasing in p , which can be seen from evaluating the derivative of Π_B there: $8.5 - 2p$ is decreasing in p but still positive at $p = 3$.

When $p \in (3, 3.5)$ profits are decreasing in p , as $\Pi'_B(p) = 16.5 - 6p$, which is negative already at $p = 3$ and further decreasing beyond that.

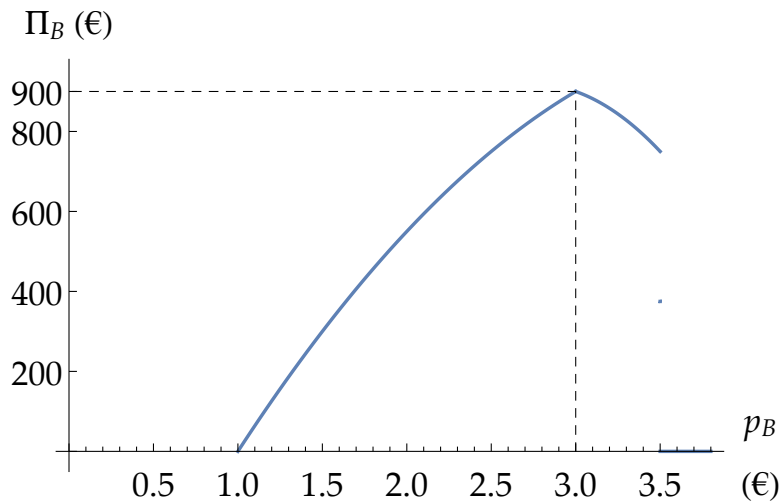

Figure 77: Bokrug's profits as a function of its price, when Abholos has set its price at €2.

Hence Bokrug's profits are maximized by charging €3 for its ice cream, which results in a profit of $\Pi_B(3) = 9$. Since here we measured distance in hundreds of meters, there are then 100 customers per each unit of distance, this translates into a profit of €900.

88. This is a horizontal differentiation problem. This version where the consumers are located in a circle is known as a "Salop circle",¹⁶ which has the analytical convenience over a Hotelling line that there are no end points that sometimes lead to special cases. Consumers are evenly distributed, consumer utility is diminishing in distance and the maximum valuation for the product is the same for all consumers.

- (a) Since all pharmacies are located equally far from their competitors on both sides, the four pharmacies are at 2.5km intervals along the 10km boulevard. Because all

¹⁶After Steven Salop (1979): "Monopolistic Competition with Outside Good".

consumers by one unit of medicine from the closes pharmacy, industry profits are:

$$\Pi_{industry} = (P_{med} - MC_{med}) \times N_{residents} - FC_{firm} \times N_{firms}$$

$$\Rightarrow$$

$$\Pi_{industry} = (\text{€}10 - \text{€}5) \times 1 \text{ million residents} - \text{€}1 \text{ million} \times 4 = \text{€}1 \text{ million}$$

The total cost of the average consumer consists of the average distance cost plus the price of the medicine. The average distance to a pharmacy is 0.625km and the price is €10, so the total cost faced by the average consumer is $0.625\text{km} \times \text{€}10/\text{km} + \text{€}10 = \text{€}16.25$.

- (b) Pharmacies will enter the market as long as they can make non-negative profits. Since the total profits in the market excl. fixed costs are €5 million and fixed costs are €1 million per pharmacy, there will be 5 pharmacies in equilibrium, all making zero profits.

In a symmetric equilibrium, the distance between each neighbouring pharmacy is the same. Hence, the pharmacies are located 2km from each other along the boulevard. Total industry profits are zero and the total cost faced by the average consumer is $0.5\text{km} \times \text{€}10/\text{km} + \text{€}10 = \text{€}15$

- (c) The price is now lower, so the total profits excluding fixed costs in the market are $(\text{€}8 - \text{€}5) \times 1 \text{ million} = \text{€}3 \text{ million}$. In a long-run symmetric equilibrium, there will be three pharmacies at 3.33km intervals along the boulevard, all making zero profits. The total cost for the average consumer is $0.833\text{km} \times \text{€}10/\text{km} + \text{€}8 = \text{€}16.33$. Since the average cost was €15 without price regulation, the welfare of the average consumer decreases by €1.33.

89. (a) This game can be solved with backward induction, starting from the last choices and working your way towards the beginning. Let's first consider player B's choice in Node 10. By choosing "Move", her payoff is 11, which is lower than the payoff of "Stop", 12. Thus, player B's choice at node 10 is "Stop". Player A knows this and her payoffs in Node 9 are thus 8 from "Move" and 9 from "Stop". Thus, player A's choice at node 9 is "Stop".

Continuing according to the same logic until choice node 1, we get as a result that the optimal strategy for both players is "Stop" at every node. The game will end at node 1 and payoffs are {1,1}.

- (b) Now consider only the choices of player A. Let's list her payoffs at every step, again starting from the end of the game.

		Payoffs	
		E[Move]	Stop
Nodes	Node 9	$(8+11)/2=9.5$	9
	Node 7	7.5	7
	Node 5	5.5	5
	Node 3	3.5	3
	Node 1	1.5	1

Since the expected payoff from moving is higher than the payoff from stopping at all of the nodes, A's payoff maximizing strategy is to always play "Move".

- (c) Player B has six available pure strategies: stopping at any of the five available nodes (and moving otherwise) and a sixth strategy of moving at every node. Let's first express player A's payoffs for the different pure strategy options she has.

Player A's payoffs

		Player B stops at					
		Node 2	Node 4	Node 6	Node 8	Node 10	Always "Move"
Player A stops at	Node 1	1	1	1	1	1	1
	Node 3	0	3	3	3	3	3
	Node 5	0	2	5	5	5	5
	Node 7	0	2	4	7	7	7
	Node 9	0	2	4	6	9	9
	Always "Move"	0	2	4	6	8	11

Let's then calculate, which pure strategy would give player A the highest expected payoff by simply summing up each row and dividing by six.

Player A's expected payoffs

		Player B stops at						Exp. payoff (A)
		N. 2	N. 4	N. 6	N. 8	N. 10	"Move"	
Player A stops at	N. 1	1	1	1	1	1	1	$6/6 = 1$
	N. 3	0	3	3	3	3	3	$15/6$
	N. 5	0	2	5	5	5	5	$22/6$
	N. 7	0	2	4	7	7	7	$27/6$
	N. 9	0	2	4	6	9	9	$30/6 = 5$
	"Move"	0	2	4	6	8	11	$31/6$

Player A will choose "Move" at every node, since it gives the highest expected payoff.

- (d) Since B weighs A's payoffs by 25% and her own payoffs by 75%, and assumes likewise about A, the game tree from B's point of view has the following payoffs:

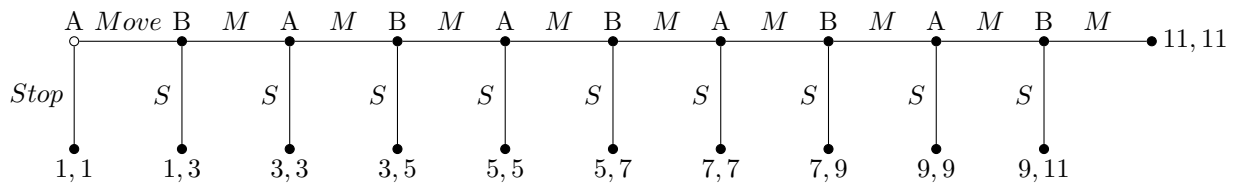

However, the true payoffs for A are the same as in the original game tree.

The utility of B for "Move" and "Stop" are equal at every decision node. Thus, she will always randomize with 50-50 probabilities and the problem is equal to 89c. The optimal strategy of player A is then to choose "Move" at every decision node.

7 Pricing

90. (a) When using uniform pricing, we can use basic pricing rule where price is at the point where $MC=MR$. To do this, we need to aggregate demand. We know that there are 750 basic users with demand curve $q_1(p) = 150-p$ and 250 high demand users with demand curve $q_2(p) = 150-0.5p$. Basic users' aggregate demand, denoted by $Q_1(p)$ and high-demand users denoted by $Q_2(p)$ are:

$$Q_1(p) = 750q_1(p) = 750(200-p) = 150000 - 750p$$

$$Q_2(p) = 250q_2(p) = 250(200-0.5p) = 50000 - 125p$$

Inverse demand curves are:

$$P_1 = 200 - \frac{Q_1}{750}$$

$$P_2 = 400 - \frac{Q_2}{125}$$

We can now write the total demand curve at different rental prices, denoted by Q_T

$$Q_T = \begin{cases} 0, & \text{when } p > 400 \\ Q_2 = 50000 - 125p, & \text{when } 200 \leq p \leq 400 \\ Q_1 + Q_2 = 200000 - 875p, & \text{when } p < 200 \end{cases}$$

The inverse demand at $p < 200$ is

$$P_T = \frac{200000 - Q_T}{875}$$

Firm's cost structure in € is: $TC(Q_T) = VC(Q_T) + FC = 50Q_T + 400000$ and $MC = 50$.

Firm's revenue function is:

$$R(P) = P \cdot Q_T = \left(\frac{200000 - Q_T}{875}\right)Q_T = \frac{200000Q_T - Q_T^2}{875}$$

$$MR = \frac{200000}{875} - \frac{2Q_T}{875}$$

when $p < 200$.

We can use optimal pricing rule in a situation where the firm sells to both customer groups, so that $p < 200$, and solve for optimal Q_T , denoted by Q^* :

$$MR = MC$$

$$\frac{200000}{875} - \frac{2Q^*}{875} = 50$$

$$200000 - 2Q^* = 43750$$

$$2Q^* = 156250$$

$$Q^* = 78125$$

By substituting Q^* in the demand equation, we get the price at this point:

$$P_T = \frac{200000 - 78125}{875} \approx 139.29$$

Firm's profit when selling to both customer groups, denoted by π_T , is:

$$\pi_T = P \cdot Q - TC = 139.29 \cdot 78125 - 78125 \cdot 50 - 4000000 = 2975781$$

Next, check the profit when the firm sells only to customers with high demand:

$$\begin{aligned} R &= P \cdot Q = \left(400 - \frac{Q_2}{125}\right)Q_2 = 400Q_2 - \frac{Q_2^2}{125} \\ MR &= 400 - \frac{2Q_2}{125} \\ MC &= MR \\ 50 &= 400 - \frac{2Q^*}{125} \\ 6250 &= 50000 - 2Q^* \\ 2Q^* &= 43750 \\ Q^* &= 21875 \end{aligned}$$

and price at $Q^* = 21875$ is $P_2 = 400 - 21875/125 = 225$. Firm's profit when selling to only high-types, denoted by π_2 , is then:

$$\pi_2 = P \cdot Q - TC = 225 \cdot 21875 - 21875 \cdot 50 - 4000000 = -171875 < 0$$

and we can see that this alternative is not profitable. It is profitable to sell to both types at price 139.29€ per rental hour.

- (b) An optimal pricing strategy in a situation where the firm cannot identify different customer types is to use a fixed price and a unit price. In other words, firm should charge a fixed fee for renting and a unit price based on rental time. This works better because this way the firm can get the surplus that the customers get for renting the robots.

Because customer types cannot be identified, the firm can set one fixed price and one rental price. Note that the demand for high-types is strictly larger than low types. In other words, their demand is higher than demand of low-types at all prices. They cannot be excluded from the market at any price that results in positive demand from the low-types.

The first case is that the firm rents to both customer groups. If the firm wants to sell to both customer groups, the firm should set the fixed fee equal to the consumer surplus of the lower valuing customer segment when the unit price is set equal to marginal cost.

The fixed fee is then equal to the consumer surplus of the low-types.

$$F(p) = CS_l = 0.5(200 - p)^2$$

We can now write down the firm's profit as a function of price p :

$$\begin{aligned} \pi(p) &= 750q_1 + 250q_2 + 1000F(p) - TC(Q_1(p), Q_2(p)) \\ \pi(p) &= (750(200 - p) + 250(200 - 0.5p))p + 500(200 - p)^2 \\ &\quad - 50(750(200 - p) + 250(200 - 0.5p)) - 6000000 \\ \pi(p) &= 43750p - 375p^2 + 4000000 \end{aligned}$$

Next, find the price p^* that maximizes the profit function:

$$\begin{aligned} \frac{\partial \pi(p)}{\partial p} &= 0 \\ 43750 - 750p^* &= 0 \\ p^* &\approx 58.33 \end{aligned}$$

Profit with this price is:

$$\pi \approx 43750 \cdot 58.33 - 375 \cdot 58.33^2 + 4000000 = 5276042$$

The profit is then around 5 €m per year.

Next case is to sell only to high-types. In this scenario, the fixed fee should equal to the consumer surplus of high types when price is equal to marginal cost.

$$\begin{aligned} q_2(p) &= 200 - 0.5 \cdot 50 = 175 \\ F(p) &= CS_h = (400 - 50)175 \cdot 0.5 = 30625 \end{aligned}$$

The profit with this pricing is:

$$\pi(p) = 250 \cdot 30625 - 6000000 = 1656250$$

The profit is around 1.5 €m per year. The firm should therefore rent to both types at 58.33€ unit price and fixed fee of $0.5(200 - 58.33)^2 = 735€$.

- (c) In both scenarios, high-demand users will rent the robots if the firm rents any robots. Therefore, if x increases, the profits from the strategy where robots are only rented to high-demand customers goes down more rapidly than the profits in the strategy where both customer-types are served. Therefore, x does not change the optimal strategy.

91. (a) Let's start by aggregating the demand from hipsters and normies. Since the price at which demand is zero is the same for both customer groups ($p = 24$), we can simply sum up the individual demands:

$$\begin{aligned} Q^D(p) &= N_H Q_H^D(p) + N_N Q_N^D(p) = 100(24 - p) + 200(12 - 0.5p) \\ &= 100(24 - p) + 200(12 - 0.5p) = 3600 - 150p \end{aligned}$$

The profit function of Warre's Buffet is:

$$\begin{aligned} \Pi(p) &= (p - MC)Q^D(p) - FC \\ &= (p - 4)(3600 - 150p) - 10\,000 \end{aligned}$$

The optimal price is:

$$\begin{aligned} \frac{\partial \Pi(p)}{\partial p} &= 4200 - 300p = 0 \\ \implies p^* &= 14 \end{aligned}$$

- (b) Since we have two customer groups and we can track which units are consumed by the same buyer, we can maximize profits by designing a two-part tariff pricing scheme with an entry fee F and a unit price P for the buffet. To design an optimal two-part tariff scheme, let's follow the steps outlined in the lecture slides. The low-type customers are the normies, since their demand curve is always below the demand curve of the hipsters.

Let's set the entrance fee so that it extracts all of normies' CS:

$$F(p) = (24 - p)Q_N^D(p) \frac{1}{2} = (24 - p)(12 - 0.5p) \frac{1}{2} = \frac{1}{4}(24 - p)^2$$

Let's then formulate the profit function of Warre's Buffet wrt. the unit price p :

$$\begin{aligned} \Pi(p) &= (N_H Q_H^D(p) + N_N Q_N^D(p))(p - MC) + (N_H + N_N)(F(p)) - FC \\ &= (100(24 - p) + 200(12 - 0.5p))(p - 4) + 300\left(\frac{1}{4}(24 - p)^2\right) - 10000 \\ &= -125p^2 + 2000p + 14000 \end{aligned}$$

Let's differentiate wrt. p to get the optimal unit price:

$$\begin{aligned} \frac{\partial \Pi(p)}{\partial p} &= -250p + 2000 = 0 \\ \implies p^* &= 8 \end{aligned}$$

The optimal entrance fee is $F(8) = \frac{1}{4}(24 - 8)^2 = 64$ euros and profits are $\Pi(8) = -125 \times 8^2 + 2000 \times 8 + 14000 = 22\,000$ euros. Let's verify that Warre is not better off by serving only hipsters by setting the entrance fee equal to their consumer surplus at the marginal cost. The entrance fee would be $F_H(4) = (24 - 4)(24 - 4)\frac{1}{2} = 200$ euros and profits:

$$\Pi_H(p) = N_H F_H(4) - FC = 100 \times 200 - 10000 = 10\,000$$

The profit-maximizing pricing strategy is to serve both groups.

- (c) Let's calculate the consumer surpluses of hipsters and normies under optimal simple pricing:

$$CS_N(p^* = 14) = N_N(24 - 14)Q_N^D(14)\frac{1}{2} = 200 \times (24 - 14)(12 - 7)\frac{1}{2} = 5\,000 \text{ €}$$

$$CS_H(p^* = 14) = N_H(24 - 14)Q_H^D(14)\frac{1}{2} = 100 \times (24 - 14)(24 - 14)\frac{1}{2} = 5\,000 \text{ €}$$

The CS of normies under two-part tariffs is zero. The consumer surplus of hipsters is:

$$CS_H(F = 64, p^* = 8) = 100 \times ((24 - 8)(24 - 8)\frac{1}{2} - 64) = 100 \times 64 = 6\,400 \text{ €}$$

As a result of two-part tariffs, normies' aggregate CS drops from 5 000 euros to zero and hipsters' aggregate CS increases from 5 000 euros to 6 400 euros.

- (d) Since serving only hipsters was not profitable even with the lower marginal cost, it clearly won't be with the higher marginal cost either - the fee will be smaller while the fixed costs stay the same. Thus the profit-maximizing pricing scheme will follow the same strategy as previously. The fee is also still the same as a function of p , since it is still targeted at extracting the surplus from the normies.

With two different marginal costs, the profit function looks slightly different:

$$\begin{aligned} \Pi(p) &= (N_H Q_H^D(p))(p - MC_H) + (N_N Q_N^D(p))(p - MC_N) + (N_H + N_N)(F(p)) - FC \\ &= 100(24 - p)(p - 6) + 200(12 - 0.5p)(p - 4) + 300\left(\frac{1}{4}(24 - p)^2\right) - 10000 \\ &= -125p^2 + 2200p + 9200 \end{aligned}$$

The optimal unit price is:

$$\begin{aligned} \frac{\partial \Pi(p)}{\partial p} &= -250p + 2200 = 0 \\ &\implies p^* = 8.8 \end{aligned}$$

The optimal entrance fee is $F(8.8) = \frac{1}{4}(24 - 8.8)^2 = 57.78$ euros. So the optimal price is higher and the optimal entrance fee lower than before. Profits will be lower than before due to the increased marginal cost of serving hipsters.

92. (a) Kärri's profit is maximized when its marginal cost equals its marginal revenue. Its marginal cost is the wholesale price P_W plus the additional marginal cost it incurs, i.e., $MC_K = P_W + 5$. Its total revenue is $TR_K = P^D(Q)Q = 200Q - (1/4)Q^2$, where P^D is the inverse of demand for $Q^D(p) = 800 - 4p$. Marginal revenue is then $MR_K(Q) = 200 - Q/2$. The manufacturer knows that Kärri will select Q to maximize its own profits, which requires $MR_K(Q) = MC_K \implies 200 - Q/2 = P_W + 5 \implies P_W = 195 - Q/2$, which is in effect the demand faced by the manufacturer.

The manufacturer's total revenue from Lintukoto is then $TR_M(Q) = (195 - Q/2)Q = 195Q - (1/2)Q^2$, so its marginal revenue is $MR_M(Q) = 195 - Q$. Its profits are maximized when $MC_M = MR_M(Q) \implies MC_M = 195 - Q$. Kärri is currently dealing 160 vehicles, so the MC_M that is consistent with the manufacturer currently charging a profit-maximizing wholesale price is $MC_M = 195 - 160 = 35$.

- (b) The combined profit is maximized when total marginal revenue equals total marginal cost. Note that payments between the manufacturer and the retailer cancel out—they are costs for one, but revenue for the other—so total marginal revenue is the same as faced by Kärri in 92a. The total marginal cost is the sum of the real marginal incurred by the retailer and the manufacturer, i.e., $35 + 5 = 40$. The profit-maximizing condition is therefore $200 - Q/2 = 40 \implies Q = 320$, which plugged into the inverse demand yields the retail price $p^m = P^D(320) = 120$.
- (c) Currently, Kärri's profit is $TR_K - Q \times MC_K = 160 \times 160 - 160 \times 120 = 6400$ and the manufacturer's profit is $TR_M - Q \times MC_M = 115 \times 160 - 160 \times 35 = 12800$. We know from 92b that combined profits are maximized when $P^D = 120$, yielding combined profits of $\Pi_C(P^D) = 960 \times 120 - 4 \times 120^2 - 32000 = 25600$. Hence the increase in combined profits is $25600 - (6400 + 12800) = 25600 - 6400 - 12800 = 6400$. This can be achieved with a two-part tariff, which optimally involves the manufacturer selling vehicles to Kärri at its marginal cost €35k and only making profits from the license fee. This gets rid of the problem of *double marginalization* seen in part 92a, where both the retailer and the manufacturer used simple pricing in succession, raising the consumer price to a level that is inefficiently high from the point of view of combined profits.

For the resulting increase in combined profits to be shared equally between the parties, Kärri must pay a license fee equal to the manufacturer's original profit plus half of the increase in profits, $12800 + 6400/2 = 16000$, i.e., €16m per year.

93. (a) Market demand is:

$$\begin{aligned} Q^D(P) &= 0 && , \text{ when } P \geq 80 \\ &= 80 - \frac{2}{3}P && , \text{ when } 80 > P \geq 70 \\ &= Q_1^D(P) + Q_2^D(P) = 150 - \frac{5}{3}P && , \text{ when } 70 > P \geq 0 \end{aligned}$$

Invert piecewise:

$$\begin{aligned} P^D(Q) &= 90 - 0.6Q && , \text{ when } 150 > Q \geq 33\frac{1}{3} \\ &= 120 - 1.5Q && , \text{ when } 33\frac{1}{3} > Q \geq 0 \end{aligned}$$

Let's first solve for the optimal price and profits when serving both customer types with uniform pricing and compare that to only serving high type customers.

When serving both customer types, the profit function is:

$$\begin{aligned} \Pi(Q) &= (N_1 + N_2)(P^D(Q)Q - TC(Q, N)) - FC_{powerplant} \\ &= 20000((90 - 0.6Q)Q - 20Q - 500) - 10Me \\ &= 20000(70Q - 0.6Q^2 - 500) - 10Me \end{aligned}$$

Let's maximize this with respect to Q:

$$\begin{aligned} \frac{\partial \Pi(Q)}{\partial Q} &= 20000(70 - 1.2Q) = 0 \Leftrightarrow \\ Q^* &= \frac{70}{1.2} = \frac{350}{6} \approx 58.3 \end{aligned}$$

And thus $P^* = 90 - \frac{3}{5} \times \frac{350}{6} = 55$. Profits are:

$$\begin{aligned} \Pi(58.3) &= 20000((P^* \times Q^* - MC \times Q^* - FC_i) - FC_{powerplant}) \\ &= 20000(55 \times 58.3 - 20 \times 58.3 - 500) - 10Me \\ &\approx 20.81 \text{ million euros} \end{aligned}$$

When serving only high type customers, the profit function per additional customer becomes:

$$\begin{aligned} \Pi_1(P) &= P \times Q - MC \times Q - FC_i \\ &= P(80 - \frac{2}{3}P) - 20(80 - \frac{2}{3}P) - 500 \\ &= -\frac{2}{3}P^2 + \frac{280}{3}P - 2100 \end{aligned}$$

Maximizing that:

$$\frac{\partial \Pi_1(P)}{\partial P} = \frac{1}{3}(-4P + 280) = 0 \Leftrightarrow$$

$$P_1^* = 70$$

With $P_1^* = 70$, $Q_1^* = 33\frac{1}{3}$. Total profits from selling only to high type customers then become:

$$\begin{aligned} \Pi_1(70) &= 10000 \times (70 \times 33\frac{1}{3} - 20 \times 33\frac{1}{3} - 500) - 10Me \\ &\approx 10000 \times 1165 - 10Me \\ &\approx 1.65 \text{ million euros} \end{aligned}$$

Selling to both customer types is more profitable. The consumer surplus for a low type customer is:

$$CS_2(P^*) \approx \frac{(70 - 55)(70 - 58.3)}{2} \approx 87.8$$

The consumer surplus for a high type customer:

$$CS_1(P^*) \approx \frac{(120 - 55)(80 - \frac{2}{3}58.3)}{2} \approx 1336.8$$

Aggregate consumer surplus:

$$N_1 \times CS_1(P^*) + N_2 \times CS_2(P^*) \approx 10000 \times 1336.8 + 10000 \times 87.8 \approx 14.2 \text{ million euros}$$

- (b) This is a two-part tariff problem. Let's first solve the profit maximizing entry fee and price when selling for both types. The entry fee that extracts the full CS of low types is:

$$F(P) = (70 - P)Q_2(P)\frac{1}{2} = \frac{(70 - P)^2}{2}$$

The profit function:

$$\begin{aligned} \Pi(P) &= Q \times P + N \times F(P) - TC(N, Q) - FC_{powerplant} \\ &= Q \times (P - MC) + N \times (F(P) - FC_i) - FC_{powerplant} \\ &= (N_1 Q_1(P) + N_2 Q_2(P))(P - MC) + (N_2 + N_1)(F(P) - FC_i) - FC_{powerplant} \\ &= (10000(80 - \frac{2}{3}P) + 10000(70 - P))(P - 20) + 20000(\frac{(70 - P)^2}{2} - 500) - 10Me \\ &= \dots \\ &= \frac{-20000}{3}P^2 + \frac{1300000}{3}P - 10Me \end{aligned}$$

Maximizing with respect to price:

$$\frac{\delta \Pi(P)}{\delta P} = \frac{1}{3}(-40000P) + 1300000 = 0 \Leftrightarrow$$

$$P^* = \frac{1300000}{40000} = 32.5$$

The entry fee is:

$$F^* = F(32.5) = \frac{(70 - 32.5)^2}{2} = 703.125$$

Profits from selling to both types:

$$\begin{aligned} \Pi(32.5) &= (10000Q_1(32.5) + 10000Q_2(32.5))(32.5 - 20) + 20000(703.125 - 500) - 10000000 \\ &\approx 7291667 + 4687500 + 4062500 - 10000000 \\ &\approx 6.04 \text{ million euros} \end{aligned}$$

Let's check whether selling only to high types would be more profitable. The optimal entry fee would be:

$$F_1^* = CS_1(20) = \frac{(120 - 20)(80 - \frac{2}{3}20)}{2} = \frac{100 \times \frac{200}{3}}{2} \approx 3330$$

And profits:

$$\begin{aligned} \Pi_1^* &= N_1 \times (F_1^* - FC_i) - FC_{powerplant} \\ &\approx 10000(3330 - 500) - 10Me \\ &\approx 18.3 \text{ million euros} \end{aligned}$$

Selling only to high customer types is more profitable. The entry fee takes away the whole consumer surplus.

- (c) Since it is possible to set a different connection fee for different customer types, the optimal solution is to set connection fees so that they take away all of the CS of both types and price equal to marginal cost ($P = MC = 20$). The optimal connection fee for the high types was solved in 93b and is approximately 3330 euros. The optimal connection fee for low types is:

$$F_2^* = CS_2(20) = \frac{(70 - 20)(70 - 20)}{2} = 1250$$

Consumer surplus is zero. Profits are:

$$\begin{aligned} \Pi^* &= N_1 \times F_1^* + N_2 \times F_2^* - (N_1 + N_2) \times FC_i - FC_{powerplant} \\ &\approx 10000 \times 3330 + 10000 \times 1250 - 20000 \times 500 - 10Me \\ &\approx 25.8 \text{ million euros} \end{aligned}$$

- (d) The answer is the same as in 93c, since in a two-part tariff pricing scheme it is always optimal to charge $P = MC$ for all customer types, if it is possible to set different entry fees for each customer type.

94. (a) Notice that the health-conscious customers here are the low demand types while low-income customers are the high-demand types. Here “L” refers to “low income” and “H” to “health conscious” types. Notice also that it doesn’t matter for the pricing decision whether there are one or one million customers of each type. Let’s assume, for convenience, that there is one consumer of each type.

Suppose first that the firm wants to sell both types of gruel. The profit maximizing version prices in this case are such that it sets the price of thin gruel equal to the lowest valuation (the valuation of H-types, 1.2 €) and then sets the price of thick gruel as high as it can be so that the types with the highest valuation (L-types) will select it instead of thin gruel. This is achieved when the price of thick gruel, p , is set so that $1.5 - 1.2 = 2.9 - p \implies p = 2.6$. Such a pricing strategy yields the firm a profit of $2.6 - 2 + 1.2 - 1 = 0.6 + 0.2 = 0.8$.

Now suppose the firm instead sells only thick gruel. If it wants to sell to both types, it should set the price equal to the lower valuation, which would yield a profit of $2 \times (2.3 - 2) = 0.6$ if instead it only sells to the L-types, it should set the price to its valuation, yielding it a profit of $2.9 - 2 = 0.9$. Also note that since the difference between the valuations and marginal cost of thin gruel is smaller than for thick gruel for both types, selling thin gruel exclusively can’t be more profitable. Hence, selling only thick gruel to L-types exclusively is the most profitable pricing scheme.

- (b) Suppose there are 100 customers, α percent of whom are L-types. Selling only thick gruel at 2.9 euros yields a profit of $100\alpha \times 0.9 + 100(1 - \alpha) \times 0$. Selling to both types yields a profit of $100\alpha \times 0.6 + 100(1 - \alpha) \times 0.2$. The former strategy will be more profitable than the latter as long as

$$\begin{aligned} 100\alpha \times 0.9 &> 100\alpha \times 0.6 + 100(1 - \alpha) \times 0.2 \\ \implies 0.9\alpha &> 0.6\alpha + 0.2 - 0.2\alpha \\ \implies \alpha(0.9 - 0.6 + 0.2) &> 0.2 \\ \implies \alpha &> \frac{0.2}{0.5} = 0.4 \end{aligned}$$

Thus when the H-types make up more than 60% of the market, the firm should switch to selling both types of gruel. Again the actual number of customers did not matter for optimal pricing.

95. (a) The profit maximizing pricing scheme is to either sell to the high-type (seller is in a hurry) or to sell both low and high-type customers.

We can calculate first the profit if the firm sells only to high-types. The profit maximizing price in this case is to price overnight delivery, denoted as p_H , at 40€. Denote profit for this strategy as π_H . There are 1 million potential deliveries of which 50 percent are in a hurry. The profit in €m is:

$$\pi_H = (40 - 5) \cdot 0.5 = 17.5$$

The company can also sell to both types of customers. The profit maximizing strategy is to price the low-type package so that the surplus for customers that are not in a hurry is zero. Price of the regular service, p_L , should be 12€. Because customers can choose which service to choose, the company needs to price its services so that high-type customers want to choose the high-type service. In other words, the incentive compatibility -constraint needs to hold:

$$B_H(H) - P_H \geq B_H(L) - P_L$$

We know that $P_L = 12$, $B_H(H) = 40$, $B_H(L) = 15$. Note that when selling to both customer types, the higher quality service cannot be priced at 40 when lower type is priced at 12 because then customers in a hurry will choose the regular service. The IC-constraint needs to hold as an equality because profit is increasing in p_H :

$$\begin{aligned} 40 - P_H &= 15 - 12 \\ P_H &= 40 - 3 = 37 \end{aligned}$$

Profit when selling to both customers, π_B , is:

$$\pi_B = 37 \cdot 0.5 + 12 \cdot 0.5 - 1 \cdot 5 = 19.5$$

The optimal strategy is to sell to both types and profit is 19.5 €m.

- (b) We can calculate profits of different pricing schemes for the company. One alternative is to sell only to high-types at 40€, which generates 17.5 €m profits. Another alternative is to sell to both types at one price. The optimal price would be to sell only overnight service at 20€. Profit for this service would be:

$$\pi_B = (20 - 5) \cdot 1 = 15$$

So the optimal is to sell only to high-types at 40. The consumer surplus is zero in this case. In a.) the low-types received no surplus and the high-types received as much as the IC-constraint allowed them to have. The surplus in 95a is:

$$CS_T = CS_L + CS_H = 0 + (B_H(H) - P_H) \cdot 0.5 = (40 - 37) \cdot 0.5 = 1.5$$

So the loss in CS_T in 95a compared to 95b is -1.5€m.

- (c) Denote marginal cost for regular service as $MC_r = x$ and $MC_o = 5$. We can rewrite profit when selling to both types as a function of regular service's marginal cost. The optimal in a.) was to sell to both types. Then we can calculate the point where the optimal strategy just holds:

$$\begin{aligned}\pi_B &\geq \pi_H \\ (37 - 5) \cdot 0.5 + (12 - x) \cdot 0.5 &\geq 17.5 \\ 22 - 0.5x &\geq 17.5 \\ 0.5x &\leq 4.5 \\ x &\leq 9\end{aligned}$$

So the marginal cost for regular service needs to be lower or equal to 9 for the optimal strategy in 95a to hold. So if $MC_r = 9$, the strategy just holds.

- (d) We can rewrite the profit of different pricing schemes as a function of customer-type shares. Denote the number of customers that are in a hurry as s million and the ones that are not in a hurry as $1 - s$ million. Different pricing strategies include: 1.) sell only to high-types, 2.) sell to both customer types with two services and 3.) sell only one service type to both customers. The strategies are denoted as H , B and B' . Because the share of high types goes down from 0.5, we know that the strategy where the company only sells to high-types is not going to be optimal with any s below 0.5. It is sufficient to compare the last two strategies.

Profits with these pricing strategies are:

$$\begin{aligned}\pi_B &= (37 - 5) \cdot s + (12 - 5)(1 - s) \\ \pi_B &= 32s + 7 - 7s \\ \pi_B &= 25s + 7\end{aligned}$$

and by selling the high-service to both types:

$$\pi_{B'} = 20 - 5 = 15$$

With what values of s does $\pi_B \geq \pi_{B'}$ just hold:

$$\begin{aligned}\pi_B &\geq \pi_{B'} \\ 25s + 7 &\geq 15 \\ 25s &\geq 8 \\ s &\geq \frac{8}{25} = 32\%\end{aligned}$$

The original strategy is better when the share of hurry-types is 32 percent or higher. If the share decreases to any lower than 32 percent, then it is optimal to switch to selling only high-service at price 20€ to both customer-types.

- (e) The alternative pricing strategies are to sell to all three customer types three different services. The company should set the super-slow service at price 10, $p_s = 3$. Now it needs to ensure that customers that are not in a hurry want to choose the regular service instead of the super-slow service. IC-constraint states that the customers not in a hurry need at least a surplus of 2 from choosing regular service. The company should set $P_r = 10$, showing that it does not make sense to price-discriminate the lowest two customer types. It should either sell to all at $p_r = 10$ or to exclude the laid-back customers completely by setting $p_r = 12$ or sell only to high-types. The profit from the last strategy is 17.5 €m. The profit from excluding the lowest type is:

$$\pi_E = 0.25 \cdot (12 - 5) + 0.5 \cdot (37 - 5) = 17.75$$

and the profit for selling to all customers is:

$$\pi_A = 0.5 \cdot (10 - 5) + 0.5 \cdot (37 - 5) = 17.5$$

We can tell that the profit-maximizing strategy is to exclude the laid back and sell to "in hurry" types and "not in hurry" types and get a profit of 17.75 €m.

96. (a) The phone manufacturer should use quality versioning in its pricing. Since both consumer types value the Special cellphone more, it is the high-quality version and the Basic phone is the low-quality version. Note that the Techies' premium for the added quality of the Special phone is higher than that of the Ordinaries'.

	Basic	Special	Quality premium
Ordinary	300e	360e	$360 - 300 = 60e$
Techie	450e	720e	$720 - 450 = 270e$

Since there's an equal number of Ordinaries and Techies and the variable cost is the same for both phones, we can assume that there is only one person of both types. Clearly, if only one version is to be sold, it is the high-quality one, since higher quality doesn't incur any extra costs. The phone manufacturer has two relevant options:

1. Sell only the Special phone

At price 360e, both customer types will buy and profits are $2 \times (360 - 100) = 520$ euros At price 720e only the Techies buy and profits are $(720 - 100) = 620$ euros

2. Sell both versions

The highest price for the Basic version with which the Ordinaries will buy is 300.

For the Techies to buy the Special version, they will have to get at least the same consumer surplus as from buying the Basic version, so P_S must satisfy $720 - P_S \geq 450 - 300$, from which we get $P_S \leq 570$. With this strategy, profits are $(570 - 100) + (300 - 100) = 670$ euros.

The profit maximizing pricing strategy is to sell both versions, the Special version at price 570 euros and the Basic version at price 300 euros. Profits are 670 euros.

(b) If the basic version has a logo, customer valuations would be the following:

	Basic with logo	Special without logo	Quality premium
Ordinary	300	360	$360 - 300 = 60$
Techie	$450 - 50 = 400$	720	$720 - 400 = 320$
Cost	$100 + 5 = 105$	100	

The one version sales strategy is the same as before, with profits at 620e. In the two version strategy the price is 300e, so that the Ordinaries will buy the product. The Techies will buy the Special phone as long as $720 - P_S \geq 400 - 300$, from which we get $P_S \leq 620$. Profits are now $(620 - 100) + (300 - (100 + 5)) = 715$ euros. The phone manufacturer maximizes its profits by selling the Basic phone with a logo at 300e and the Special phone without a logo for 620e.

Note: The benefit of quality versioning for the manufacturer is due to one customer group valuing the quality difference by more. A binding constraint for pricing is the worry that the Techies would choose to buy the Basic version. In this case the manufacturer benefits from increasing the quality difference by making the Basic version less appealing to the Techies by adding a logo on them, since the price increase it permits is higher than the added cost.

(c) The optimal pricing strategy depends on X in the following way:

1. If $|X| \leq 5$, the manufacturer is better off by not adding the logo, since the added cost is higher than the benefit of the logo in terms of pricing
2. If $X < -5$, the manufacturer should add the logo on the Basic phone. This is by the same logic as in 96b: adding the logo increases the quality difference between the products for Techies and thus allows for an increased price for the Special phone.
3. If $X > 5$, the manufacturer should add the logo on the Special phone. This leads to a higher valuation of the Special phone by the Techies, which again allows for an increased price for the Special phone.

97. (a) This is a problem of quantity discounts, where we want to solve for the optimal package sizes and prices for chocoholics (High type) and ordinaries (Low type). Let's first express the total benefit from consuming Q units for both types by using the formula $B(Q) = \alpha Q - (\beta/2)Q^2$ (area of a trapezoid):

$$Q_H(p) = 50 - 10p \Leftrightarrow B_H(q) = 5q - \frac{1}{20}q^2$$

$$Q_L(p) = 30 - 6p \Leftrightarrow B_L(q) = 5q - \frac{1}{12}q^2$$

i). The large package is of the efficient size for H-types (“no distortion at the top”):

$$P_H(q_H) = MC \Leftrightarrow 5 - \frac{1}{10}q_H = 0.5$$

$$q_H^* = 45$$

ii). The price of the small package will extract all surplus from the low types (“no surplus at the bottom”):

$$P_L(q_L) = B_L(q_L) \Rightarrow P_L(q_L) = 5q_L - \frac{1}{12}q_L^2$$

iii). Price of large package is such that high types will choose that and not the low-type package (“self-selection constraint”):

$$\begin{aligned} P_H(q_L) &= B_L(q_L) + (B_H(q_H^*) - B_H(q_L)) \\ &= 5q_L - \frac{1}{12}q_L^2 + (5 \times 45 - \frac{1}{20} \times 45^2 - (5q_L - \frac{1}{20}q_L^2)) \\ &= -\frac{1}{30}q_L^2 + \frac{495}{4} \end{aligned}$$

iv). Using these results, let’s formulate the profit function and maximize:

$$\begin{aligned} \Pi(q_L) &= N_L P_L(q_L) + N_H P_H(q_L) - (N_L q_L + N_H q_H^*) \times MC \\ &= 100(5q_L - \frac{1}{12}q_L^2) + 200(-\frac{1}{30}q_L^2 + \frac{495}{4}) - (100q_L + 200 \times 45) \times 0.5 \\ &= 500q_L - \frac{25}{3}q_L^2 - \frac{20}{3}q_L^2 + 24\,750 - 50q_L - 4\,500 \\ &= -15q_L^2 + 450q_L + 20\,250 \end{aligned}$$

Maximization:

$$\begin{aligned} \frac{\partial \Pi(q_L)}{\partial q_L} &= -30q_L + 450 = 0 \\ \Rightarrow q_L^* &= 15 \end{aligned}$$

The optimal {small, large} packages $\{q_L^* = 15, q_H^* = 45\}$ priced at:

$$P_L^* = B_L(45) = 5 \times 15 - \frac{1}{12}15^2 = 56.25 \text{ €}$$

$$P_H^* = P_H(45) = -\frac{1}{30}15^2 + \frac{495}{4} = 116.25 \text{ €}$$

v). Comparison of profits. Selling to both types with optimal quantity discount:

$$\Pi(15) = -15 \times 15^2 + 450 \times 15 + 20\,250 = 23\,625 \text{ €}$$

Selling only to high types (at high type reservation price):

$$\begin{aligned}\Pi_H(q_H^*) &= N_H(B_H(q_H^*) - MC \times q_H^*) \\ &= 200 \times (5 \times 45 - \frac{1}{20}45^2 - 0.5 \times 45) \\ &= 20\,250 \text{ €}\end{aligned}$$

Selling to both types is more profitable than selling only to high types.

(b) *i*). The new optimal large package size:

$$\begin{aligned}P_H(q_H) = MC &\Leftrightarrow 5 - \frac{1}{10}q_H = 1.4 \\ q_H^* &= 36\end{aligned}$$

ii). The price of the large package:

$$\begin{aligned}P_H(q_L) &= B_L(q_L) + (B_H(q_H^*) - B_H(q_L)) \\ &= 5q_L - \frac{1}{12}q_L^2 + (5 \times 36 - \frac{1}{20} \times 36^2 - (5q_L - \frac{1}{20}q_L^2)) \\ &= -\frac{1}{30}q_L^2 + \frac{576}{5}\end{aligned}$$

iii). The profit function:

$$\begin{aligned}\Pi(q_L) &= N_L P_L(q_L) + N_H P_H(q_L) - (N_L q_L + N_H q_H^*) \times MC \\ &= 100(5q_L - \frac{1}{12}q_L^2) + 200(-\frac{1}{30}q_L^2 + \frac{576}{5}) - (100q_L + 200 \times 36) \times 1.4 \\ &= 500q_L - \frac{25}{3}q_L^2 - \frac{20}{3}q_L^2 + 23\,040 - 140q_L - 10\,080 \\ &= -15q_L^2 + 360q_L + 12\,960\end{aligned}$$

And its maximization:

$$\begin{aligned}\frac{\partial \Pi(q_L)}{\partial q_L} &= -30q_L + 360 = 0 \\ \implies q_L^* &= 12\end{aligned}$$

The optimal {small, large} packages $\{q_L^* = 12, q_H^* = 36\}$ priced at:

$$\begin{aligned}P_L^* &= B_L(12) = 5 \times 12 - \frac{1}{12}12^2 = 48 \text{ €} \\ P_H^* &= P_H(12) = -\frac{1}{30}12^2 + \frac{576}{5} = 110.4 \text{ €}\end{aligned}$$

Let's then calculate the inflation in price per chocolate piece for both customer types by comparing prices per piece before and after the supply crunch (Price inflation = $\frac{P_{new}}{Q_{new}} / \frac{P_{old}}{Q_{old}}$):

$$\begin{aligned} \text{P.infl}_L &= \frac{48}{12} / \frac{56.25}{15} \approx 6.7\% \\ \text{P.infl}_H &= \frac{110.4}{36} / \frac{116.25}{45} \approx 18.7\% \end{aligned}$$

The high-type customers end up with higher price inflation. Lastly, let's verify that this still is the profit-maximizing strategy by comparing the profits of selling to both types to the profits of selling only to high types:

$$\text{Both types: } \Pi(12) = -15 \times 12^2 + 360 \times 12 + 12\,960 = 15\,120 \text{ €}$$

$$\text{Only high types: } \Pi_H(q_H^*) = 200 \times (5 \times 36 - \frac{1}{20}36^2 - 1.4 \times 36) = 12\,960 \text{ €}$$

Selling to both types is more profitable, which means the price inflation calculations are valid.

- (c) The cocoa price increase increases the marginal cost to 1.40 euros / piece compared to the 0.50 euros / piece before. Box sizes stay the same as before i.e., $\{q_L^* = 15, q_H^* = 45\}$. The demands are

$$Q_H(p) = 50 - 10p$$

$$Q_L(p) = 30 - 6p$$

Hence total benefits are (based on the old exercise)

$$B_H(q) = 5q - \frac{1}{20}q^2$$

$$B_L(q) = 5q - \frac{1}{12}q^2$$

The firm can discontinue a box size or change the prices but not the package size.

The total benefits for each possible package size and consumer type combination are

$$B_H(15) = 5 \times 15 - \frac{1}{20} \times 15^2 = 63.75$$

$$B_L(15) = 5 \times 15 - \frac{1}{12} \times 15^2 = 56.25$$

$$B_H(45) = 5 \times 45 - \frac{1}{20} \times 45^2 = 123.75$$

$$B_L(45) = 5 \times 45 - \frac{1}{12} \times 45^2 = 56.25$$

If the boxes are sold for both types of consumers, the profits are

$$\begin{aligned} \pi &= 100 \times (B_L(15) - 15\text{MC}) + 200 \times (B_L(15) + (B_H(45) - B_H(15)) - 45\text{MC}) \\ &= 100 \times (56.25 - 15 \times 1.4) + 200 \times (116.25 - 45 \times 1.4) = 14175 \end{aligned}$$

Benefit increase per piece sold between small and large packages are for chocoholics

$$(B_H(45) - B_H(15))/30 = 60/30 = 2 > 1.4 = MC$$

Hence, it makes sense to sell larger packages for chocoholics always.

If the company sells only for chocoholics, the profit is

$$\pi = 200 \times (123.75 - 45 \times 1.4) = 12150 < 14175$$

Therefore, prices and package availability stays unchanged. That is, $\{p_M = 116.25, Q_M = 45, p_L = 56.25, Q_L = 15\}$.

Consumer welfare differences by type compared to the long run when package sizes can be changed.

The optimal quantities and prices have already been computed for the previous exercise. They are

$$\{p_H^* = 110.4, q_L^* = 36, p_L^* = 48, q_L^* = 12\}$$

Therefore, long run total benefits are

$$B_H(36) = 5 \times 36 - \frac{1}{20} \times 36^2 = 115.2$$

$$B_L(12) = 5 \times 12 - \frac{1}{12} \times 12^2 = 48$$

Hence, there is no change in the consumer surplus of ordinary types because both the pricing schemes extract all benefits from the low demand type consumers. For chocolics, the benefit change is computed from the change in differences between total benefits and prices.

$$(115.2 - 110.4) - (123.75 - 116.25) = -2.7$$

and hence, the aggregate benefit change is $-2.7 \times 200 = -540$.

98. (a) Let's solve for the optimal quantity discount scheme. It is easy to see by plotting the two demand curves that industrial customers are the high-type customers, so let's denote them as type "H" and professional customers as low-type "L". The demand functions and total benefit functions for both types are:

$$\text{High-types (industrial)} : \begin{cases} Q_H(P) = 840 - 40P \\ P_H(Q) = 21 - \frac{1}{40}Q \\ B_H(Q) = 21Q - \frac{1}{80}Q^2 \end{cases}$$

$$\text{Low-types (professional)} : \begin{cases} Q_L(P) = 300 - 15P \\ P_L(Q) = 20 - \frac{1}{15}Q \\ B_L(Q) = 20Q - \frac{1}{30}Q^2 \end{cases}$$

i). The large package is of the efficient size for H-types (“no distortion at the top”):

$$P_H(Q_H) = MC \Rightarrow 21 - \frac{1}{40}Q_H = 10 \Leftrightarrow \\ Q_H^* = 440$$

ii). The price of the small package will extract all surplus from the low types (“no surplus at the bottom”):

$$P_L(Q_L) = B_L(Q_L) \Rightarrow P_L(Q_L) = 20Q_L - \frac{1}{30}Q_L^2$$

iii). Price of large package so that high types will choose that and not the low-type package (“self-selection constraint”):

$$P_H(Q_I) = B_L(Q_L) + (B_H(Q_H^*) - B_H(Q_L)) \Rightarrow \\ P_H(Q_I) = 20Q_L - \frac{1}{30}Q_L^2 + (21 \times 440 - \frac{1}{80} \times 440^2 - 21Q_L + \frac{1}{80}Q_L^2) \\ = -\frac{1}{48}Q_L^2 - Q_L + 6820$$

iv). Using these results, let’s formulate the profit function and maximize:

$$\begin{aligned} \Pi(Q_L) &= N_L \times P_L + N_H \times P_H - (N_L \times Q_L + N_H \times Q_H^*) \times MC - FC \\ &= 3000 \times (20Q_L - \frac{1}{30}Q_L^2) + 1000 \times (-\frac{1}{48}Q_L^2 - Q_L + 6820) \\ &\quad - (3000Q_L + 1000 \times 440) \times 10 - 2m \\ &= 60000Q_L - 100Q_L^2 - \frac{125}{6}Q_L^2 - 1000Q_L + 6.82m \\ &\quad - 30000Q_L + 4.4m - 2m \\ &= -\frac{725}{6}Q_L^2 + 29000Q_L + 0.42m \end{aligned}$$

Maximization:

$$\frac{\delta \Pi(Q_L)}{\delta Q_L} = -\frac{725}{3}Q_L + 29000 = 0 \Leftrightarrow \\ Q_L^* = \frac{3}{725} \times 29000 = 120$$

The optimal {small, large} packages $\{Q_L^* = 120, Q_H^* = 440\}$ priced at:

$$P_L^* = B_L(120) = 20 \times 120 - \frac{1}{30}120^2 = 1920 \text{ euros} \\ P_H^* = P_H(120) = -\frac{1}{48}120^2 - 120 + 6820 = 6400 \text{ euros}$$

v). Comparison of profits. Selling to both types with optimal quantity discount:

$$\Pi(120) = -\frac{725}{6}120^2 + 29000 \times 120 + 0.42m = 2.16 \text{ million euros}$$

Selling only to high type (at high type reservation price):

$$\begin{aligned} \Pi(0) &= N_H(B_H(Q_H^*) - MC \times Q_H^*) - FC \\ &= 1000 \times (21 \times 440 - \frac{1}{80}440^2 - 10 \times 440) - 2m \\ &= 1000 \times (9240 - 2420 - 4400) - 2m = 0.42 \text{ million euros} \end{aligned}$$

Selling to both types with optimal quantity discount is the profit-maximizing pricing scheme with package sizes and prices $\{Q_L^*, Q_H^*, P_L^*, P_H^*\}$ equal to $\{120, 440, 1920, 6400\}$ and profits at 2.16 million euros.

(b) Let's formulate the quantity discount profit as functions of both Q_L and N_H :

$$\begin{aligned} \Pi(Q_L, N_H) &= N_L \times P_L + N_H \times P_H - (N_L \times Q_L + N_H \times Q_H^*) \times MC - FC \\ &= 3000 \times (20Q_L - \frac{1}{30}Q_L^2) + N_H \times (-\frac{1}{48}Q_L^2 - Q_L + 6820) \\ &\quad - (3000Q_L + N_H \times 440) \times 10 - 2m \\ &= 60000Q_L - 100Q_L^2 - 2m + N_H(-\frac{1}{48}Q_L^2 - Q_L + 2420) \end{aligned}$$

Let's then find the optimal Q_L as a function of N_H :

$$\begin{aligned} \frac{\partial \Pi(Q_L, N_H)}{\partial Q_L} &= 30000 - 200Q_L - \frac{1}{24}N_H - N_H = 0 \Leftrightarrow \\ Q_L(200 + \frac{1}{24}) &= 30000 - N_H \Leftrightarrow \\ Q_L^* &= \frac{30000 - N_H}{200 + \frac{1}{24}N_H} \end{aligned}$$

It is optimal to sell to only high types, when $Q_L^* = 0$. This happens, when:

$$\begin{aligned} \frac{30000 - N_H}{200 + \frac{1}{24}N_H} &= 0 \Rightarrow \\ N_H &= 30000 \end{aligned}$$

Thus, when $N_H \geq 30000$, the firm makes more profits by setting $Q_L = 0$ and selling only to the high types.

Note: When selling also to low-demand types the seller has to lower the price of the large package to keep the buyer self-selection working as intended. When the share of high-demand types grows, the profits earned from low-demand types become less

important relative to their negative impact on the price of the large package. Thus the optimal size of the small package gets smaller as N_H is increased. But it cannot be less than zero! If there were some fixed cost of packaging, the smaller package would have a positive minimum size.

99. For the purpose of the optimal pricing it is convenient to transform the customer reservation values into values net of marginal cost. Let's also add the net valuations for the bundle in the same table. Since the goods are neither substitutes or complements, the customer valuation for a bundle is simply the sum of the valuations for the two goods.

€	Grouse	Pineapple	Bundle
Bourgeois	10	10	20
Students	1	8	9
Workers	9	6	15

There is an equal number of each type, so we can simplify by assuming for now that there is one of each. The absolute number of customers does not affect the relative profitability of various pricing strategies when the marginal costs are constant for each good.

- (a) For each good there are three possible price points that correspond to selling to one, two or three customer types. Consider first the pricing of grouse. By selling to all customers profits are $3 \times 1 = 3$, by selling to two highest-value types profits are $2 \times 9 = 18$, and by only selling to highest-value types profits are merely 1×10 .

Similarly, for pineapple, the comparison is between $3 \times 6 = 18$, $2 \times 8 = 16$, and 1×10 , of which selling to all three types is the best.

As there are 100 customers of each type, maximized profits are $100 \times (18 + 18) = 3600$ euros. Adding back the MCs to optimal net prices yields the actual optimal "list prices" as $9 + 5 = 14$ euros for grouse and $6 + 3 = 9$ euros for pineapple.

- (b) Under pure bundling only the bundle is sold and priced using basic pricing. Just like in part 99a, let's compare profits at the three relevant price points: $3 \times 9 = 27$, $2 \times 15 = 30$, and 1×20 . Maximized total profits are $100 \times 30 = 3000$ euros (worse than basic!). Optimal price for the pure bundle includes the marginal costs: $15 + 5 + 3 = 23$ euros.

- (c) With mixed bundling, Acme can allow either grouse, pineapple, or both to be bought as individual items separately from the bundle. If both are sold then the sum of prices is more than the price of the bundle. Just like under basic pricing, any deal that is on sale must be just at the borderline of inducing a profitable sale to one of the customer types.

Let's first depict all three types in "type space", where each axes represents the net valuations for one good, see Figure 78.

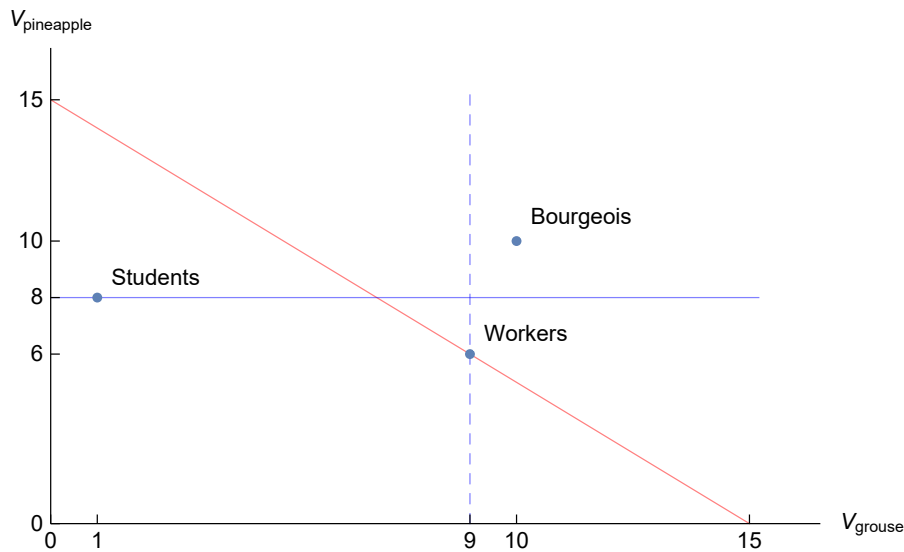

Figure 78: Consumer types in net valuation space.

It is apparent that students are the type with a relatively high value for pineapple, hence, if pineapple is to be sold separately then its price will be determined by the student value 8. Similarly, if grouse is to be sold separately its price will be determined by worker value at 9. The bourgeois have a higher valuation for both goods than other types. This means that their valuations cannot be binding if Acme is to use a mixed bundling strategy. No matter what strategy is used, the bourgeois will buy the bundle.

If students are the type that will only buy one good then the bundle price is determined by workers, and profits are $8 + 2 \times 15 = 38$. (Acme could at the same time also sell grouse at any price that exceeds the worker value 9, but there would not be much point as no one would buy it.) If workers were the type that is only sold one good then the bundle price would be determined by students, but at their bundle valuation 9 workers would also buy the bundle, so that would just amount to selling the bundle to all types (for a profit of only $3 \times 9 = 27$).

The optimal mixed bundling strategy earns total profits of $100 \times 38 = 3800$ euros. The list prices are $8 + 3 = 11$ euros for pineapples and $15 + 3 + 5 = 23$ euros for the bundle. Mixed bundling is the most profitable pricing strategy considered here. It can never do worse than basic pricing or pure bundling because it includes both as special cases.

100. (a) If X and Y are priced separately, we can calculate the profits at different prices. Note that at P_x all types with $V_X \geq P_x$ will buy the good at that price. For X, the optimal price is 4 and profit at that price is 68. For Y, the optimal price is 4 and profit at that price is 76.

- (b) For the bundle, all individuals with valuation $V_X + V_Y \geq P_b$ buy the bundle in pure bundling situation. The optimal price is 5 and profit is 135 at that price.
- (c) For mixed bundling, the firm is selling X and Y separately and the bundle. Now, consumer will buy the bundle if $(V_X + V_Y \geq P_b)$ AND $(V_X + V_Y - P_b \geq V_X + V_Y - P_X - P_Y)$ AND $(V_X + V_Y - P_b \geq V_X - P_X)$ AND $(V_X + V_Y - P_b \geq V_Y - P_Y)$. In words, the customer buys the bundle if the surplus is nonnegative and the bundle generates higher surplus compared to buying both goods or one good separately.

For solving the problem, it is used as an assumption that when surplus is tie for different alternatives, the choice which gives higher profit to the seller is chosen.

Using these rules and calculating numerically with the Excel solver (see the separate file [bundling_solver.xlsx](#)), the mixed bundling prices that give highest profit for the firm is either $P_X = 4, P_Y = 5, P_B = 7$ or $P_X = 5, P_Y = 5, P_b = 7$. These pricing schemes give equal profits for the firm, 145.

8 Externalities

101. (a) The expected net benefit of a Zorgian who is considering sending a satellite to LZO is, as a function of existing satellites in LZO:

$$\begin{aligned} E(\Pi(n)) &= 10(1 - p(n)) - 10p(n) \\ &= 10 - 10 \times 10^{-6}n^2 \end{aligned}$$

The expected benefit declines as the number of satellites increases. Zorgians will send satellites to the orbit up to the point where the expected private net benefit drops to zero. Let's solve for this point:

$$\begin{aligned} E(\Pi(n)) &= 10 - 10 \times 10^{-6}n^2 = 0 \\ &\Leftrightarrow \\ n &= 1000 \end{aligned}$$

There will be 1000 satellites in LZO. Expected value generated is zero.

- (b) Total welfare (TW) of LZO satellites equals to the number of satellites times expected private net benefit per satellite. Let's express this as a function of n :

$$\begin{aligned} E(\text{TW}(n)) &= n \times E(\Pi(n)) \\ &= n \times \{10(1 - p(n)) - 10p(n)\} \\ &= n(10 - 10 \times 10^{-6}n^2) \\ &= 10n - 10^{-5}n^3 \end{aligned}$$

Let's differentiate this wrt. n to get the optimal number of satellites

$$\begin{aligned} \frac{\partial E(\text{TW}(n))}{\partial n} &= 10 - 3 \times 10^{-5}n^2 = 0 \\ &\implies n^2 = \frac{10}{3 \times 10^{-5}} \\ n &\approx 577 \end{aligned}$$

577 satellites in LZO maximizes expected total welfare.

- (c) A satellite sender considers only her private benefit but causes a negative externality to all other satellites in LZO. An optimal tax balances the expected private benefit of an additional satellite with the negative externality. Since we know that the negative externality exceeds the expected marginal net benefit if the number of satellites is higher than 577, we need to solve for a tax per satellite sent that makes

it unprofitable to send more than 577 satellites to LZO. Thus, the tax needs to be equal to the expected private net benefit evaluated at $n = 577$:

$$E(\Pi(577)) = 10 - 10 \times 10^{-6} \times 577^2 \approx 6.67 \text{ \$Alt}$$

The optimal tax is 6.67 \$Alt.

102. (a) The welfare (profit) of an individual tuna fisher is $v(n) = 2x(n) - 20$. The efficient number of fishing boats maximizes the total welfare, i.e. the number of fishers times their individual welfares:

$$\begin{aligned} W(n) &= nv(n) \\ &= n(2 \times (80 - 0.2n) - 20) \\ &= 140n - 0.4n^2 \end{aligned}$$

Maximizing the above with respect to n gives the first order condition $140 - 0.8n = 0 \implies n_{SE} = 175$. This would give each fisher a catch of $x(175) = 80 - 0.2 \times 175 = 45$, yielding a profit of $v(175) = 2 \times 45 - 20 = 70$. The total profit from the total catch ($175 \times 45 = 7875$) tons is $175 \times 70 = 12250$ monetary units.

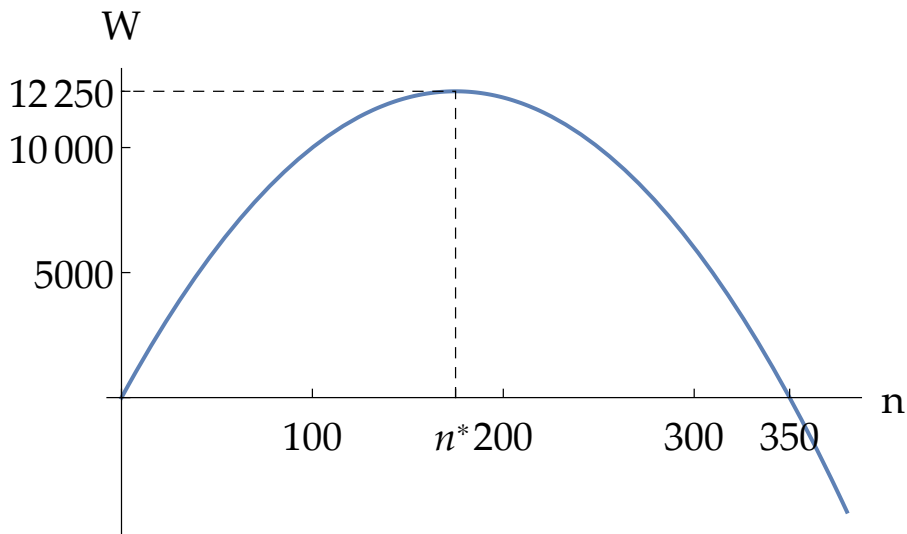

Figure 79: Total welfare as a function of the number of fishing boats in part 102a.

- (b) Without restrictions, tuna boats will enter until the welfare of the next entrant falls below zero. That is, another tuna fisher will enter as long as:

$$\begin{aligned} v(n) &= 2x(n) - 20 \geq 0 \\ \implies 160 - 0.4n - 20 &\geq 0 \\ \implies 0.4n &\leq 140 \\ \implies n_{EQ} &\leq 350 \end{aligned}$$

meaning that 350 tuna fishing boats will enter without restrictions on their entry. The per-boat tuna catch in this case is $x(350) = 80 - 0.2 \times 350 = 10$, meaning that the total catch is $350 \times 10 = 3500$ tons. The profits, per boat and in total, are by definition zero. Hence, without restrictions, the total catch drops to less than a half of the efficient case, while the profits drop to zero.

- (c) We know from 102a that total welfare is maximized when $n = 175$. The market price of the license, p , will be equal to the benefit for the n th entrant, i.e. $p = v(n)$. Again, we know from 102a that $v(175) = 70$. Hence, market price in the socially efficient case is $p_{SE} = v(175) = 70$.

103. (a) No one will choose a slower road voluntarily, so in equilibrium either the travel time is the same on both roads or all drivers use the same road. Here the Expressway is certainly faster at 30 minutes before congestion kicks in at 5000 drivers, but would be slower than the Highway if everyone used the Expressway, so there will in equilibrium be drivers on both roads. The Highway is at its fastest at 45 minutes as long as it gets no more than 500 drivers, at which point the Expressway would take $T_1(10000 - 500) = 30 + 4500/50 = 120$ minutes. Therefore in equilibrium both roads will be congested, which means that between 5000 and 9500 drivers take the Expressway. Travel times are equal if n drivers take the Expressway, the remaining $10000 - n$ the Highway. Therefore

$$\begin{aligned} 30 + (n - 5000)/50 &= 45 + (10000 - n - 500)/100 \implies \\ 30 + n/50 - 100 &= 45 - n/100 + 95 \implies \\ n &= 7000 \end{aligned}$$

choose the Expressway and remaining 3000 the Highway. This calculation amounted to finding the crossing point of two travel times functions, shown in Figure 80, but note that for this to work both travel times must be written as a function of the same variable. Equilibrium travel time on both roads and therefore also the average travel time is $T_1(7000) = T_2(3000) = 70$ minutes.

- (b) Here the maximization of welfare amounts to minimization of total (and average) travel time. Let's set up the total travel time as a function of the number of drivers on Expressway. Let's again use n to denote the drivers on the Expressway. If $n < 5000$ then the Expressway is faster than the Highway but not congested, so clearly optimal n will be above 5000. I.e., if $n < 5000$ it is possible to shift drivers from Highway to Expressway without slowing down the Expressway at all. Since at

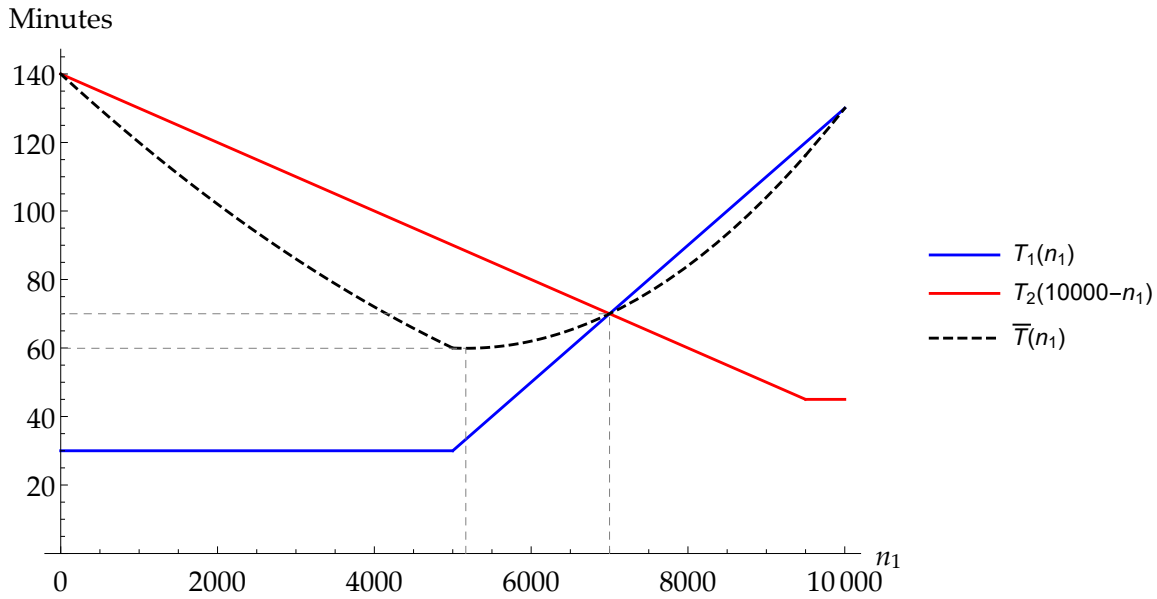

Figure 80: Travel times as a function of n_1 , the number of drivers on the Expressway.

the optimum both roads will be congested we can write total travel time as

$$\begin{aligned}
 T(n) &= nT_1(n) + (10000 - n)T_2(10000 - n) \\
 &= n \left(30 + \frac{n - 5000}{50} \right) + (10000 - n) \left(45 + \frac{10000 - n - 500}{100} \right) \\
 &= n \left(\frac{1}{50}n - 70 \right) + (10000 - n) \left(140 - \frac{1}{100}n \right) \\
 &= \frac{3}{100}n^2 - 310n + 1400000
 \end{aligned}$$

The first order condition is

$$\frac{6n}{100} - 310 = 0 \implies n^* = \frac{31000}{6} \approx 5167.$$

As T is an upwards opening parabola this is indeed the minimizer. The resulting average travel time is $\bar{T}^* = T(5167)/5167 \approx 60$ minutes. Average travel time is depicted as the dashed curve in Figure 80. Note that at optimum the Expressway is faster, at $T_1(n^*) = 33 \frac{1}{3}$ minutes while the Highway takes $T_2(10000 - n^*) = 88 \frac{1}{3}$ minutes.

A welfare-maximizing road pricing scheme must incentivize the right amount of drivers to choose the Highway even while it is slower by $T_2(n^*) - T_1(n^*) = 55$ minutes. Given that the drivers value saved time at €0.2/minutes, there must be a toll of $55 \times 0.2 = 11$ euros on the Expressway.¹⁷ This toll makes the drivers indifferent

¹⁷More generally, any combination of tolls where the Expressway is more expensive by 11 euros works here.

between the two roads, and if too many drivers were taking the Expressway then the saved time there would no longer be worth the toll.

The toll increases welfare by reducing average travel time by $70 - 60 = 10$ minutes, which is worth $10000 \times 10 \times 0.2 = 20$ thousand euros to the drivers. This is also the impact of the road pricing on total welfare. The drivers will pay in total $n^* \times 11 \approx 56.8$ thousand euros of tolls, which does not affect total welfare but it is a pure transfer from drivers to the government.

As an aside, the welfare-enhancing toll is a deadweight-loss-free source of revenue for the government, so in principle it enables the reduction of some welfare-loss inducing tax elsewhere in the economy.

- (c) All low income drivers will choose the Expressway as it is faster and costs the same. High income drivers, on the other hand, will choose the Highway only as long as the time saved there is worth the €11 toll, which is the case when the time saving is 55 minutes. Hence again the total number of drivers on the Expressway will be unchanged from part 103b. Hence, in equilibrium the Highway is fully populated by high income drivers and Expressway has all the low income drivers and $n^* - 5000 \approx 167$ high income drivers. Average travel time is the same for everyone as in part 103b, but many fewer drivers are paying the toll. Total welfare is unaffected, but the transfer from drivers to the government is smaller. It is now only $167 \times 11 \approx 1.8$ thousand euros, about €50k less than before.

In part 103b it was not determined who pays the toll and who takes the Highway, because every driver had the same level of welfare. Now the low-income drivers are better off by the amount of the toll. Relative to part 103b, they get a transfer of $5000 \times 11 = 55k$ euros from the government. High income drivers' welfare is not affected, they are still indifferent between taking the Expressway + paying the toll and taking the Highway.

104. (a) **i).** More visitors will come to the park up to the point where the private value for the n th visitor is no more positive. In the equilibrium, the number of visitors is:

$$\begin{aligned} V_1(n) &= 200 - 2n - 16 = 0 \Leftrightarrow \\ n &= 92 \end{aligned}$$

Total welfare is zero.

- ii).** The aggregate welfare is:

$$V_1(n) \times n = (200 - 2n - 16) \times n$$

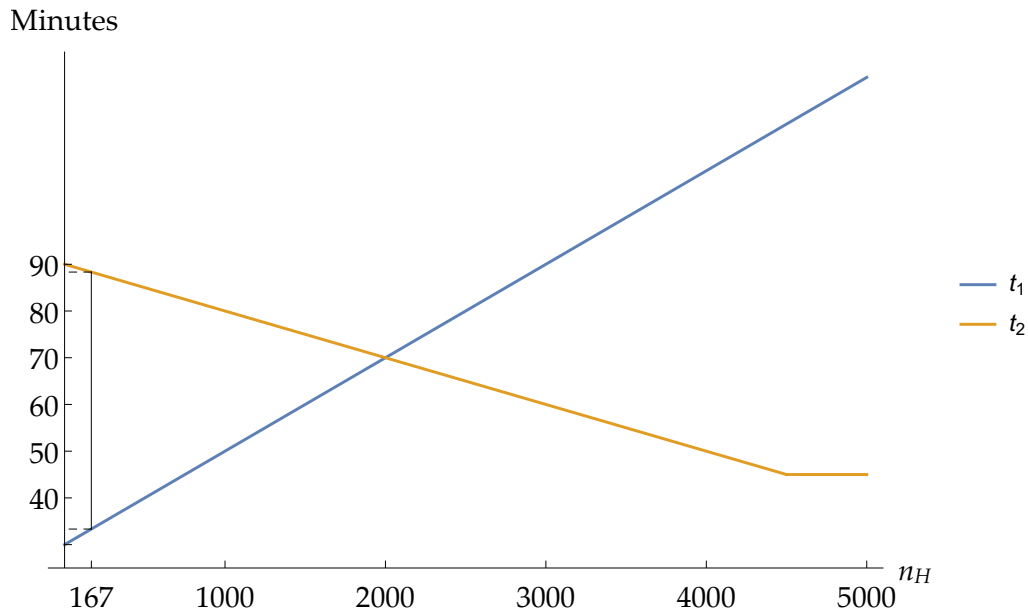

Figure 81: Travel times as a function of the number of high-income drivers on the Expressway in part 103c.

Let's maximize this with respect to n to get the welfare maximizing number of visitors:

$$\frac{\partial V_1(n)}{\partial n} = 184 - 4n = 0 \Leftrightarrow$$

$$n^* = 46$$

Let's then define an entry fee which would lead to 46 thousand visitors:

$$V_1(46) = 200 - 2 \times 46 - 16 = 92 \text{ euros}$$

With this entry fee, there will be $92 - 46 = 46$ thousand fewer visitors and welfare will be higher by $46k \times 92 = 4.232$ million euros.

- (b) i). In the case of two parks, the 200 thousand potential visitors will divide between the parks so that both parks give the same value to visitors:

$$200 - 2n_1 - 16 = 300 - 2n_2 - 16$$

$$n_2 = n_1 + 50$$

Let's then solve for the number of visitors to the parks from the total number of potential visitors:

$$n_1 + n_2 = 200 \Leftrightarrow$$

$$n_1 + n_1 + 50 = 200$$

$$n_1 = 75$$

n_2 will then be $n_1 + 50 = 125$, and the value from visiting either of the parks is $V_1(n) = V_2(n) = 200 - 2 \times 75 - 16 = 34$. Total welfare is $34 \times 200k = 6.8$ million euros.

ii). Aggregate welfare is:

$$V_1(n_1) \times n_1 + V_2(n_2) \times n_2 = (200 - 2n_1 - 16) \times n_1 + (300 - 2n_2 - 16) \times n_2$$

Since welfare from one of the parks doesn't depend on welfare from the other park, the optima can be solved independently for both parks. For park one, this has already been solved in 104a, so $n_1 = 46$ and the entry fee 92 euros.

Let's maximize also for park 2:

$$\frac{\partial V_2(n_2) \times n_2}{\partial n_2} = 284 - 4n = 0 \Leftrightarrow$$

$$n_2^* = 71$$

Let's then define an entry fee which would lead to 71 thousand visitors:

$$V_1(71) = 300 - 2 \times 71 - 16 = 142 \text{ euros}$$

Aggregate welfare from park 2 is $71k \times 142 = 10.082$ million euros. Combined aggregate welfare from parks 1 and 2 is $4.232 + 10.082 = 14.314$ million euros, which is $14.314 - 6.8 = 7.514$ million euros higher than without the entry fee.

(c) i). With travel cost 8 euros instead of 16 euros, the equilibrium number of visitors is:

$$V_1(n) = 200 - 2n - 8 = 0 \Leftrightarrow$$

$$n = 96$$

Total welfare is zero.

ii). The aggregate welfare is:

$$V_1(n) \times n = (200 - 2n - 8) \times n$$

Let's maximize this with respect to n to get the welfare maximizing number of visitors:

$$\frac{\partial V_1(n) \times n}{\partial n} = 192 - 4n = 0 \Leftrightarrow$$

$$n^* = 48$$

Let's then define an entry fee which would lead to 48 thousand visitors:

$$V_1(48) = 200 - 2 \times 48 - 8 = 96 \text{ euros}$$

With this entry fee, there will be $96 - 48 = 48$ thousand fewer visitors than without the fee and welfare will be higher by $48k \times 96 = 4.608$ million euros.

105. Let's first formulate the probabilities that Acme gets a patent in two different situations: only Acme studies a certain disease or both study the same disease:

$$Pr_{patent}(Acme) = p = 0.75$$

$$Pr_{patent}(Both) = \underbrace{0.5 \times p^2}_{\text{both succeed}} + \underbrace{p(1-p)}_{\text{Acme succeeds}} = 0.5 \times 0.75^2 + 0.75 \times 0.25 = 0.46875$$

These probabilities are naturally the same for Becme.

- (a) This is a game where Acme moves first, Becme sees its choice and chooses second. For Becme, the expected profits, given Acme's choice, are:

$$\begin{aligned} \text{Acme studies Common} & \begin{cases} E[\Pi_B(\text{Common})] & = Pr_{patent}(\text{Both}) \times 10 \approx 4.7 \text{ billion euros} \\ E[\Pi_B(\text{Rare})] & = Pr_{patent}(\text{Becme}) \times 4 = 3 \text{ billion euros} \end{cases} \\ \text{Acme studies Rare} & \begin{cases} E[\Pi_B(\text{Common})] & = Pr_{patent}(\text{Becme}) \times 10 = 7.5 \text{ billion euros} \\ E[\Pi_B(\text{Rare})] & = Pr_{patent}(\text{Both}) \times 4 \approx 1.9 \text{ billion euros} \end{cases} \end{aligned}$$

Thus, Acme knows that whatever it decides, Becme will try to develop a cure for the Common disease. By studying Rare, Acme's expected profits would be 3 billion euros. Studying Common is more profitable (4.7 billion euros), so both will study the Common disease.

Expected total profits are approximately $2 \times 4.7 = 9.4$ billion euros. Expected total surplus is $9.4 \times 10 = 94$ billion euros.

- (b) Now we have a simultaneous game with the following payoffs:

		Becme	
		Common	Rare
Acme	€B Common	4.7 ; 4.7	7.5 ; 3
	Rare	3 ; 7.5	1.9 ; 1.9

In this game, the dominant strategy for both firms is to study the Common disease. Thus, expected profits and total surplus are the same as in part 105a.

- (c) The objective here is to maximize combined profits. As was solved in part 105a, the combined expected profits are 9.4 billion euros if both firms study the Common disease.

Combined expected profits are higher if one of the firms studies Common and the other Rare: $0.75 \times 10 + 0.75 \times 4 = 10.5$ billion euros. Total surplus is 105 billion euros.

- (d) Without a subsidy, both firms study the Common disease, and expected total surplus is 94 billion euros. The minimal subsidy that would make Becme study the Rare disease, given that Acme studies the Common disease, is solved from:

$$\underbrace{0.75 \times (4 + s)}_{\text{Expected profits from from Rare}} \geq \underbrace{4.7}_{\text{Exp. profits from Common}}$$

$$s^* = 2.25 \text{ billion euros}$$

With this optimal subsidy, Acme knows that Becme will study the Rare disease, if Acme chooses to study the Common disease. Thus, Acme maximizes its expected profits by studying the Common disease. Becme studies the Rare disease. Given these, the expected total surplus W is:

$$E[W_{\text{subsidy}}(\Pi_{\text{Acme}}^*, \Pi_{\text{Becme}}^*, s^*)] \approx \underbrace{7.5 + 4.7}_{\text{expected profits}} + \underbrace{9 \times (7.5 + 3)}_{\text{expected CS}} - \underbrace{2 \times 1.7}_{\text{exp. subsidy cost}}$$

$$= 103.3 \text{ billion euros}$$

This is higher than the expected total surplus without a subsidy, so the government decides to pay the subsidy.

106. (a) Car owners care about only their own benefit when choosing a car. Let's first formulate the expected private benefit from choosing a Big car and for choosing a Normal car as a function of the share of big cars (s_B) in the market:

$$\begin{aligned} \text{Big car: } E[V_B] &= P(\text{accident}) \times P(\text{serious}|\text{accident}) \times C_{\text{serious}} - C_B \\ &= 0.1s_B \times (-1000) - 20 \\ &= -100s_B - 20 \end{aligned}$$

$$\begin{aligned} \text{Normal car: } E[V_N] &= P(\text{accident}) \times P(\text{serious}|\text{accident}) \times C_{\text{serious}} \\ &= 0.1(s_B + 0.5(1 - s_B)) \times (-1000) \\ &= -50s_B - 50 \end{aligned}$$

In equilibrium, the expected benefit of owning a Big car needs to equal that of owning a Normal car ($E[V_B] = E[V_N]$):

$$\begin{aligned} -100s_B - 20 &= -50s_B - 50 \\ s_B &= \frac{3}{5} \end{aligned}$$

60% of cars will be Big. Beyond that point, the value of extra safety of the Big car to the owner is lower than the extra cost of buying a Big car.

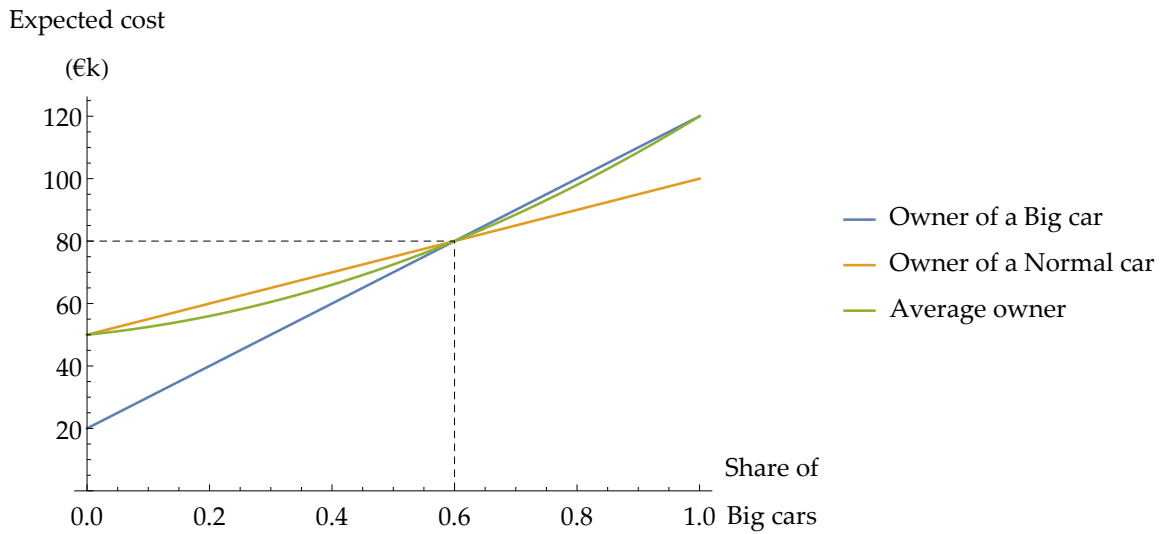

Figure 82: The expected cost of owning a Big vs. a Normal car.

- (b) Since Big cars cost more than Normal cars and since all of the extra safety they provide comes at the expense of other road users (a negative externality), it seems evident that the fraction of Big cars should be zero. This can be shown also mathematically:

$$\begin{aligned}
 \text{Expected Total Surplus: } E[TS] &= s_B(E[V_B]) + (1 - s_B)(E[V_N]) \\
 &= s_B(-100s_B - 20) + (1 - s_B)(-50s_B - 50) \\
 &= -50s_B^2 - 20s_B - 50
 \end{aligned}$$

Differentiate wrt. s_B

$$\frac{\partial E[TS]}{\partial s_B} = -100s_B - 20$$

Since the derivative is always negative for non-negative shares of Big cars, the optimal share is zero.

- (c) Now the expected private benefit from owning a Big car is higher, since it provides comfort and not only additional safety. Here it is useful to understand that we can order the consumers based on their valuation for the added comfort provided by a Big car, starting from those with the highest valuations. Then, we can formulate the expected benefit of owning a Big car for the marginal consumer:

$$\begin{aligned}
 E[V_B] &= -100s_B - 20 + \underbrace{40(1 - s_B)}_{\text{the premium on comfort for the marginal consumer}} \\
 &= -140s_B + 20
 \end{aligned}$$

The expected private benefit of owning a Normal car is the same as before. Let's solve for the equilibrium share of Big cars:

$$-140s_B + 20 = -50s_B - 50$$

$$s_B = 7/9 \approx 78\%$$

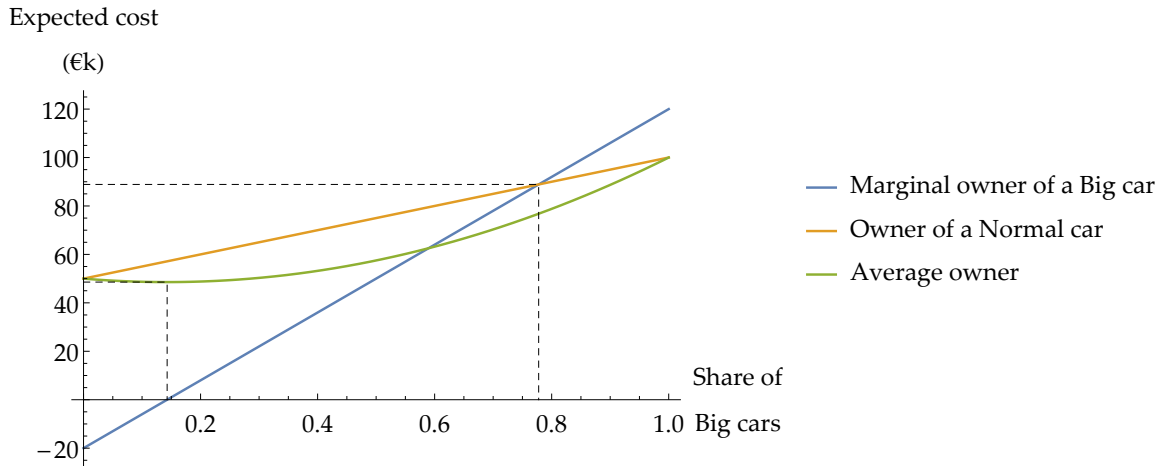

Figure 83: The expected cost of owning a Big vs. a Normal car, when consumers have different valuations for comfort.

107. (a) Households pay a price p for connecting to the network. Each household purchases a connection if and only if their surplus, $u(n)$, for connecting is larger than zero:

$$u(n) = 1 \times n - p \geq 0$$

$$p \leq n$$

The profit maximizing company extracts all the surplus by setting $p = n - 1$. The company's profit function is:

$$\pi(n) = pn - 200n - 1200000 = n \times n - 200n - 1200000 = n^2 - 200n - 1200000$$

The company breaks even when $\pi(n) = 0$:

$$n^2 - 200n - 1200000 = 0$$

$$n = 1200$$

- (b) With N households, the n th highest household has a valuation of $2 - 2n/N$. Insert $n = 1$ (household with highest valuation) or $n = 6000$ (household with lowest valuation) to confirm that valuation is between 0 and 2. With a price p , the participation

constraint is now:

$$u_n(n) = (2 - 2n/N) \times n - p \geq 0$$

$$p \leq 2n - \frac{2n^2}{N}$$

With a population $N = 6000$, setting a price

$$P(n) = 2n - n^2/3000$$

will attract the n households with the highest valuations. The company's profits are

$$\pi(n) = P(n)n - 200n - 1200000 = -\frac{n^3}{3000} + 2n^2 - 200n - 1200000$$

First-order condition is a quadratic equation:

$$\pi'(n) = -\frac{n^2}{1000} + 4n - 200 = 0$$

The sensible solution is $n \approx 3950$ (the other solution would minimize profits). The resulting profit-maximizing price is $P(3950) \approx 2700$.

- (c) Now, the total number of households is an unknown N instead of 6000. Maximized profits depend on population size and on optimal price, which also depends on population. We need to solve the smallest population N at which profits are at least zero.

We know from part 107b that the price at which n households can be attracted from a population of N is $P(n, N) = 2n - (2/N)n^2$. Profits are now

$$\begin{aligned} \pi(n, N) &= P(n, N)n - 200n - 1200000 \\ &= -\frac{2n^3}{N} + 2n^2 - 200n - 1200000 \end{aligned}$$

The first-order condition of profits wrt n is again a quadratic equation, its sensible solution gives the profit-maximizing number of customers (households) as a function of population

$$\begin{aligned} \frac{\partial \pi(n, N)}{\partial n} &= -\frac{6n^2}{N} + 4n - 200 = 0 \Rightarrow \\ n^*(N) &= \frac{1}{3} \left(N + \sqrt{(N - 300)N} \right) \end{aligned}$$

Substituting this back into the profit function results in a function of N :

$$\pi(n^*(N), N) = -\frac{2n^*(N)^3}{N} + 2n^*(N)^2 - 200n^*(N) - 1200000$$

The break-even point $\pi(n^*(N), N) = 0$ is best found numerically. Profits are plotted in Figure 84. We find that for the company to break even there must be at least $N \approx 2246$ households.

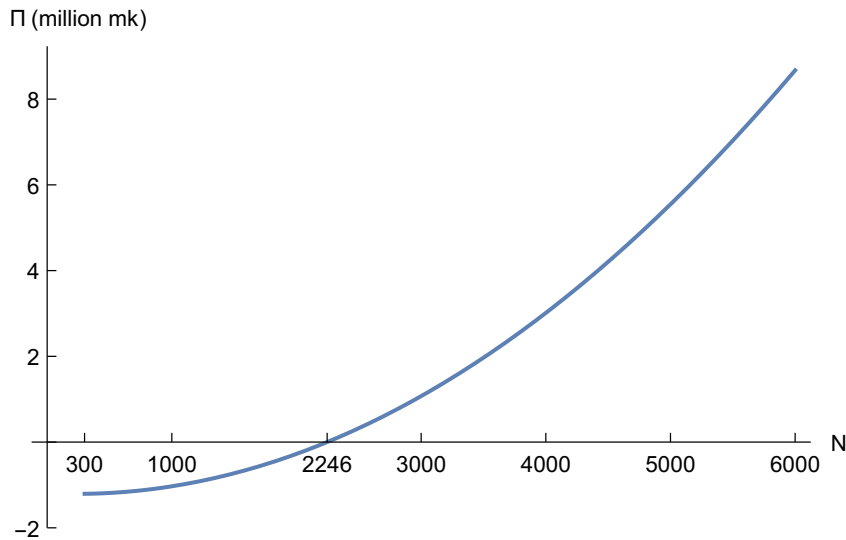

Figure 84: Maximized profits as a function of N , the number of potential customers. Since profits were positive in part 107b with $N = 6000$ we knew the break-even point is below that.

108. This is a network externality exercise, where the expected value of the country club for each members increases in the number of members.

(a) Let's first formulate the valuation of a potential member with i th highest valuation:

$$v(i) = 2 - \frac{2i}{1000}$$

With n users the n th highest user valuation is:

$$p^d(n) = nv(n) = 2n - \frac{2n^2}{1000}$$

This is how much the n th user is willing to pay for club membership, given that there are already $n-1$ members in the club. Let's then formulate the revenue that the club gets from n users:

$$R(n) = np^d(n) = 2n^2 - \frac{2n^3}{1000}$$

The country club profits are:

$$\Pi(n) = R(n) - VC(n) - FC = 2n^2 - \frac{2n^3}{1000} - 100n - 100\,000$$

Let's differentiate wrt. n and solve the resulting quadratic equation to get the profit-maximizing number of members:

$$\begin{aligned} \frac{\partial \Pi(n)}{\partial n} &= 4n - \frac{6n^2}{1000} - 100 = 0 \\ &\implies n^* \approx 641 \end{aligned}$$

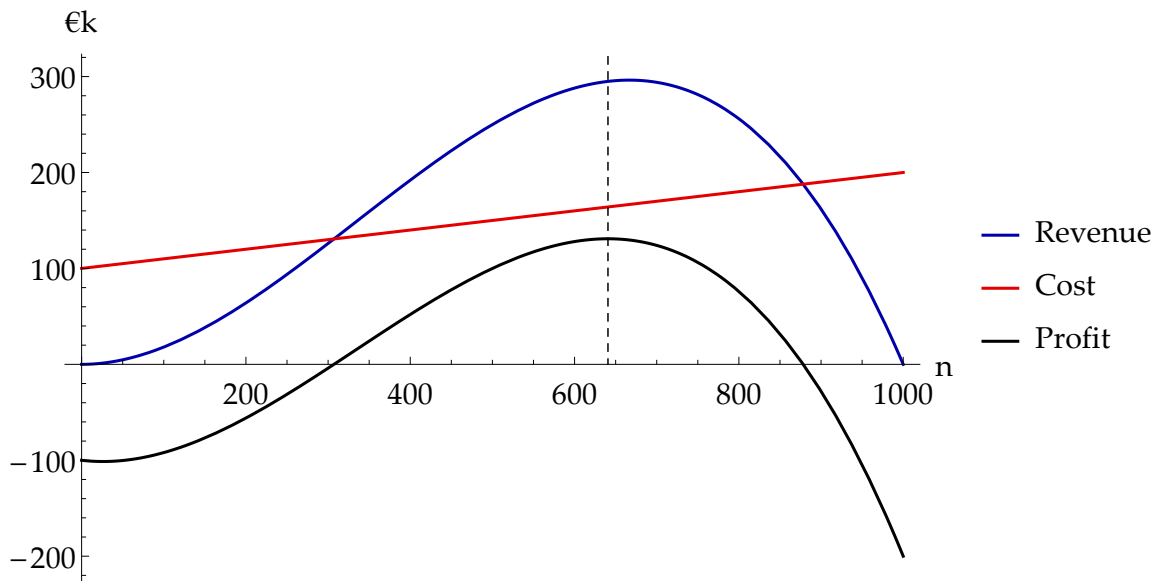

Figure 85: Revenues, costs and profit as a function of the size of membership for a profit-maximizing club.

And the profit-maximizing price of club membership:

$$p^* = p^d(641) = 2 \times 641 - \frac{2 \times 641^2}{1000} = \$460.43$$

- (b) This is an average cost pricing problem, where it is optimal that the non-profit club prices the membership so that it makes a zero profit. Positive profits would be inefficient, because they would require a higher membership price, which would reduce total surplus because it would be socially optimal for the club to have more members at the margin.

Thus, the optimal number of members is where profits are zero:

$$\Pi(n) = 2n^2 - \frac{2n^3}{1000} - 100n - 100\,000 = 0$$

This is a third-degree polynomial equation that can be solved with an equation solver. Profits are (slightly above) zero, when $n = 878$. The price of the membership is:

$$p^* = p^d(878) = 2 \times 878 - \frac{2 \times 878^2}{1000} = \$214.23$$

Club membership is higher and the price of membership is lower than with a profit-maximizing club.

Since profits are zero at the optimum, the net total surplus is equal to the aggregate consumer surplus at the efficient number of club members ($n = 878$). (There is a tiny deviation from zero due to the integer constraint, but that is not economically

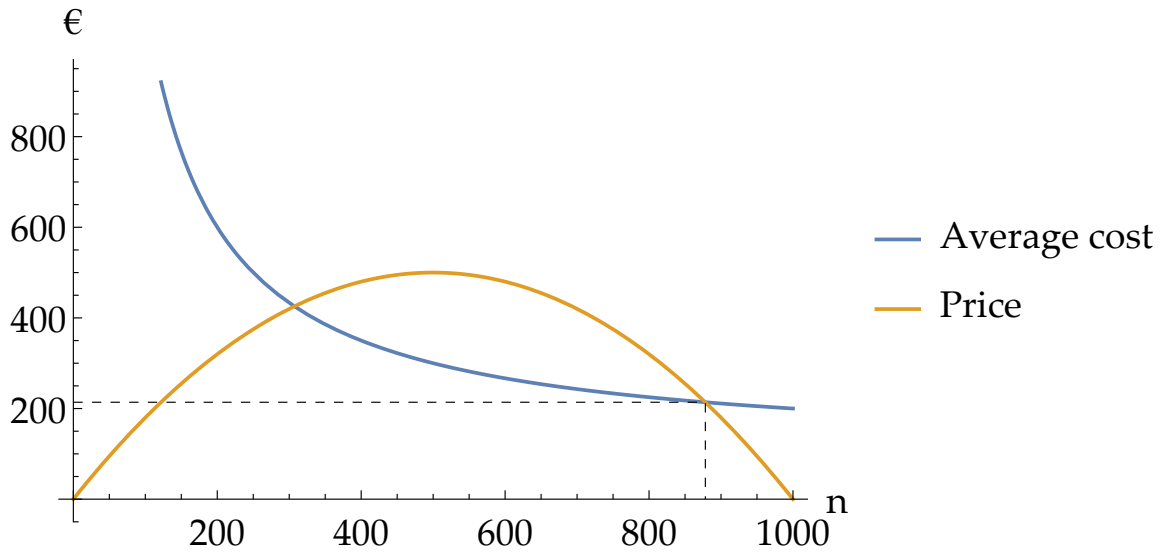

Figure 86: Average cost and price as functions of the size of club membership.

interesting). Let's formulate the consumer surplus function, when the club has n members:

$$\begin{aligned}
 CS(n) &= \underbrace{n}_{\text{number of members}} \times \underbrace{n}_{\text{potential meetings per member}} \times \underbrace{\frac{2 + (2 - \frac{2n}{1000})}{2}}_{\text{average valuation per member}} \\
 &= n^2(2 - \frac{n}{1000}) = 2n^2 - \frac{n^3}{1000}
 \end{aligned}$$

At $n = 878$, consumer surplus is $CS(878) \approx \$865\,000$

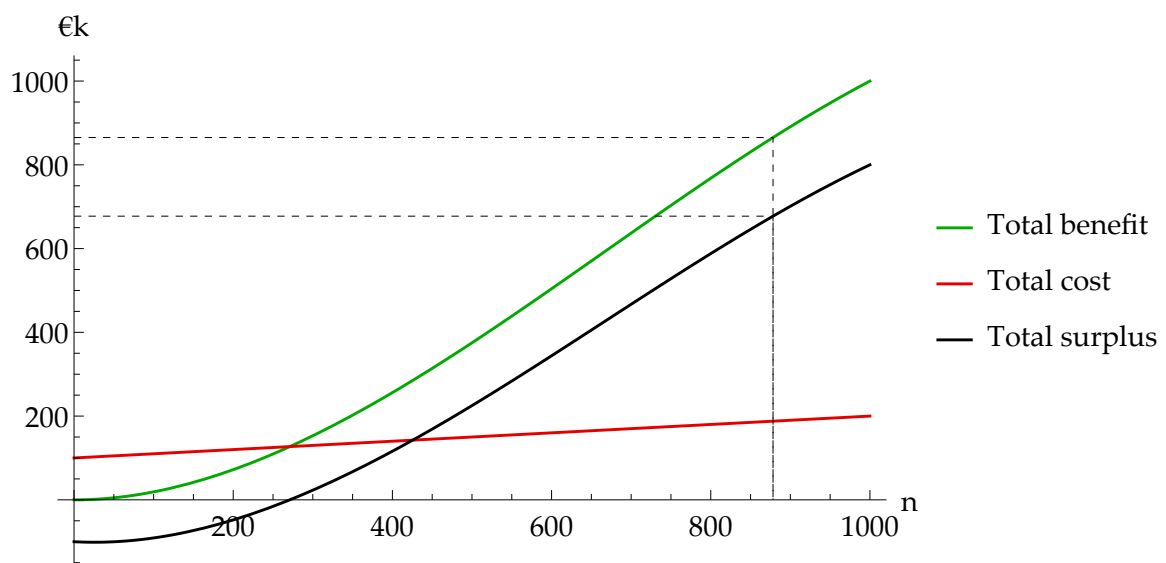

Figure 87: Consumer surplus, total cost and total surplus as a function of membership size.

(c) The question is what happens to the price of membership as population declines when the objective is to maximize total surplus subject to a balanced budget. In 108b, we saw that a non-profit club uses average cost pricing. Notice that the distribution of preferences is not affected by population size, there are just fewer potential members. Thus a larger number of members just allows the fixed cost to be divided between more people, lowering the average cost and hence the price. When the population declines then the size of membership will also decline and thus the average cost and price of membership will go up.

Additional comment. A decline in the town population would cause the profit-maximizing price to go down. The relation of prices and population is illustrated in Figure 88. Regardless of what the club’s objective is, the population has to satisfy a particular minimum scale required for the club to be able to cover its fixed costs anymore. This minimum scale is the same for a profit-maximizing club and a non-profit club because, at the minimum scale, both are making zero profits. If the population is below the minimum scale then the club cannot be sustained.

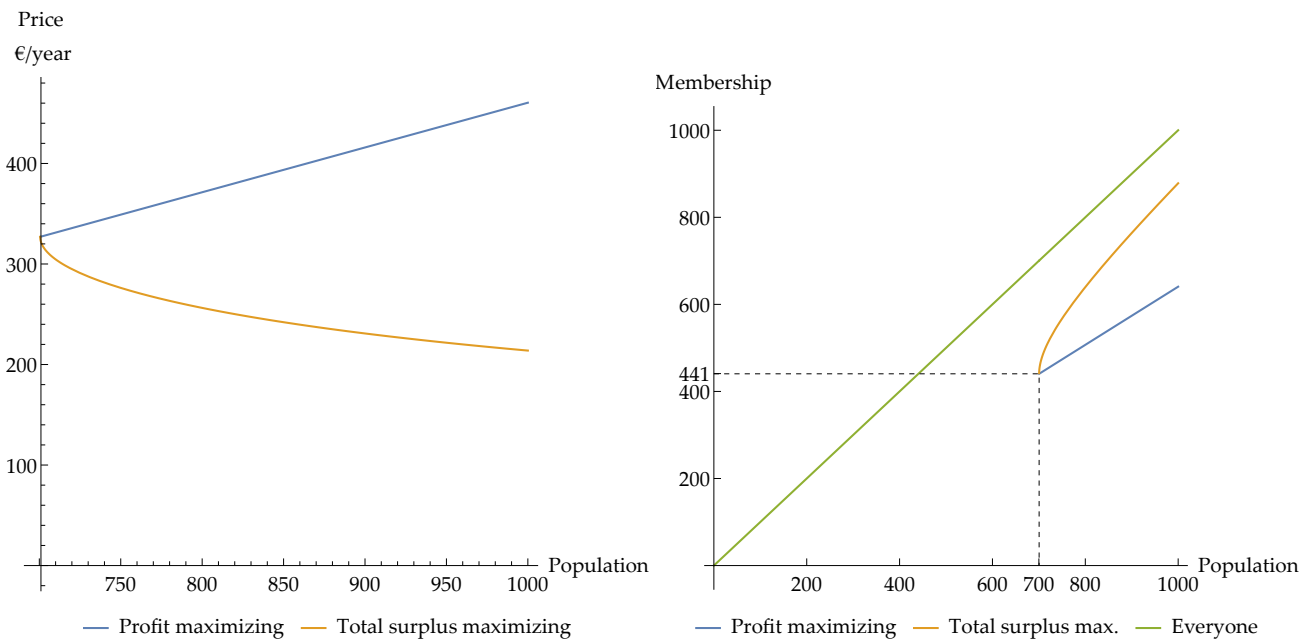

Figure 88: The optimal price of membership for a profit-maximizing and a non-profit networking club as a function of town population.

109. There is a network externality between the 200 retailers that could potentially locate in the shopping center. The valuation for locating in the shopping center is uniformly distributed in $[0, 20]$. Thus, the valuation for the retailer with the i th highest valuation is:

$$v(i) = 20 - \frac{20i}{200} = 20 - \frac{i}{10}$$

Given this, with n retailers, the n th highest user valuation (retailer profit in this case) is:

$$\begin{aligned}
 p^d(n) = nv(n) &= \underbrace{(n-1)\left(20 - \frac{n}{10}\right)}_{\text{Expected revenue from all other visitors}} + \underbrace{100 \times \left(20 - \frac{n}{10}\right)}_{\text{revenue from customers that } n \text{ brings}} \\
 &= 20n - \frac{n^2}{10} - 20 + \frac{n}{10} + 2000 - 10n \\
 &= -\frac{n^2}{10} + 10.1n + 1980
 \end{aligned}$$

- (a) The real estate company (REC) wants to maximize its profits, which are given by the number of retailers and rent per retailer, where rent is set to equal the profits of the marginal retailer. The marginal retailer is the retailer that, at a certain rent level, is indifferent between locating in the shopping center and not locating in the shopping center. Formally, the profits of the REC are:

$$\begin{aligned}
 \Pi_{REC}(n) &= n \times nv(n) = n\left(-\frac{n^2}{10} + 10.1n + 1980\right) \\
 &= -\frac{n^3}{10} + 10.1n^2 + 1980n
 \end{aligned}$$

Maximizing:

$$\begin{aligned}
 \frac{\partial \Pi_{REC}(n)}{\partial n} &= -\frac{3n^2}{10} + 20.2n + 1980 = 0 \Leftrightarrow \\
 n^* &\approx 122 \text{ (using the formula for solving quadratic equations)}
 \end{aligned}$$

The REC should build a shopping center for 122 retailers. The profit-maximizing rent is:

$$p^d(122) = -\frac{122^2}{10} + 10.1 \times 122 + 1980 = 1723.8 \text{ euros}$$

- (b) Now, the REC has a construction cost of 1000 euros per shop. Its profit function becomes:

$$\begin{aligned}
 \Pi_{REC}(n) &= n \times nv(n) = n\left(-\frac{n^2}{10} + 10.1n + 1980 - 1000\right) \\
 &= -\frac{n^3}{10} + 10.1n^2 + 980n
 \end{aligned}$$

Maximizing:

$$\begin{aligned}
 \frac{\partial \Pi_{REC}(n)}{\partial n} &= -\frac{3n^2}{10} + 20.2n + 980 = 0 \Leftrightarrow \\
 n^* &= 100 \text{ (using the formula for solving quadratic equations)}
 \end{aligned}$$

The shopping center should be built for 100 retailers. The profit-maximizing rent is:

$$p^d(100) = -\frac{100^2}{10} + 10.1 \times 100 + 1980 = 1990 \text{ euros}$$

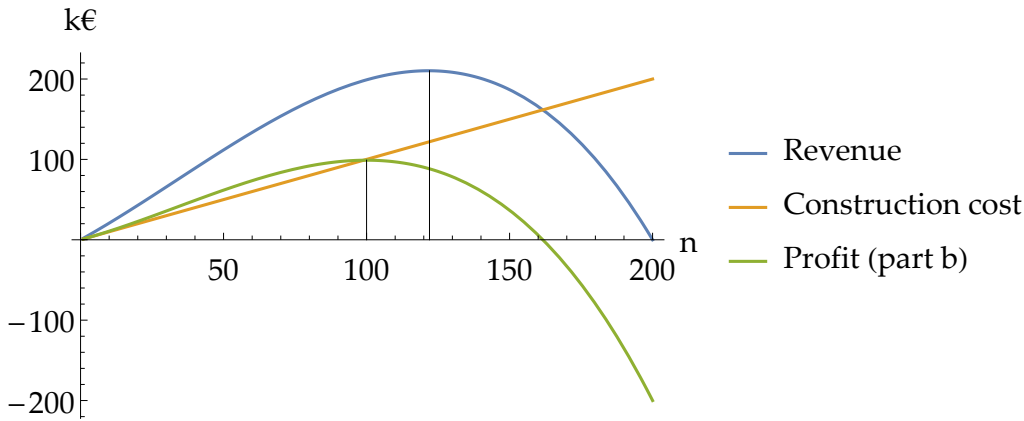

Figure 89: Revenue, costs and profit as a function of the number of retailers

110. (a) For the public investment to be worthwhile, the aggregate private benefits need to exceed the infrastructure costs. The aggregate private benefits as a function of homes built are:

$$U_{private}(n) = n \times (50000 - 0.001(n - 1000)^2)$$

Let's solve for the number of homes that just covers the €100m investment cost:

$$\begin{aligned} U_{private}(n) &\geq 10^8 \Leftrightarrow \\ n \times (50000 - 0.001(n^2 - 2000n + 1000000)) &\geq 10^8 \Leftrightarrow \\ n \times (-0.001n^2 + 2n + 49000) &\geq 10^8 \end{aligned}$$

The value n that solves the associated equality is a third order polynomial. It can be solved with a numerical solver. The resulting lowest number of houses n that covers the investment cost is 2045. (The negative root is obviously nonsensical here.)

The optimal number of houses is such that maximizes the aggregate private benefits. Let's differentiate the aggregate private benefit function with and find the optimum using the formula for solving the roots of a quadratic equation:

$$\begin{aligned} \frac{\partial U_{private}(n)}{\partial n} &= -0.003n^2 + 4n + 49000 = 0 \Leftrightarrow \\ n &= \frac{-4 \mp \sqrt{4^2 - 4 \times -0.003 \times 49000}}{2 \times -0.003} \\ &= \frac{-4 \mp \sqrt{604}}{-0.006} \approx \begin{cases} 4763 \\ -3430 \end{cases} \end{aligned}$$

When $n = 4763$, aggregate private benefits net of infra costs are maximized at approx. €70 million.

- (b) As Greenfield grows crowding costs increase but the infrastructure costs per resident decrease. The first residents would lobby for n where the increase in crowding costs per resident equals the decrease in infra costs per resident. The infrastructure cost per Greenfield resident is $\frac{10^8}{10^5+n}$ euros.

Let's formulate the marginal increase in crowding costs per resident and the marginal decrease in infra costs per resident:

$$\text{Marginal increase in crowding: } C'(n) = 0.002n - 2$$

$$\text{Marginal decrease in infra costs: } C'_{infra}(n) = \frac{10^8}{(10^5 + n)^2}$$

Let's then solve for the n where the two marginal costs are equal:

$$C'(n) = C'_{infra}(n) \Leftrightarrow$$

$$0.002n - 2 = \frac{10^8}{(10^5 + n)^2}$$

This can be solved also with a numerical solver. The two costs are approximately equal when $n = 1005$. The first residents would lobby for a neighborhood size of about a thousand homes, which is much smaller than the welfare maximizing size in part 110a.

Most of the infrastructure costs are borne by residents of other neighborhoods, but local residents still bear the local crowding costs. The first residents put no weight on the welfare of the potential future residents that would move to Greenfield if more homes were built there. Both features distort the incentives of the first local residents towards lobbying for a smaller neighborhood than what would maximize total welfare.

- (c) There is now a positive externality in addition to the negative one. Let's reformulate the aggregate private benefit function:

$$U_{private}(n) = n \times (50000 - 0.001(n - 1000)^2 + 10n)$$

Let's then find the number of homes where the aggregate private benefits exceed the infra costs:

$$U_{private}(n) \geq 10^8 \Leftrightarrow$$

$$n \times (50000 - 0.001(n - 1000)^2 + 10n) \geq 10^8$$

This can be solved also with a numerical solver. The minimum number of homes for which the investment is worthwhile is 1537, which is 598 homes fewer than in 110a.

Let's then solve for the optimal number of homes that maximizes the aggregate private benefits:

$$\frac{\partial U_{private}(n)}{\partial n} = -0.003n^2 + 24n + 49000 = 0 \Leftrightarrow$$

$$n \approx 9686$$

The optimal number of homes would be 9686. This is 4923 homes more than in 110a. The aggregate private benefits net of infra costs would be approximately €592 million.

Let's finally compare the new situation to 110b. The marginal cost of an extra resident is now:

$$C'_{net}(n) = \frac{\partial(0.001(n - 1000)^2 - 10n)}{\partial n} = 0.002n - 12$$

The residents would lobby for a number of homes where the marginal cost of an extra resident equals the marginal decrease in infra costs per resident.

$$C'_{net}(n) = C'_{infra}(n) \Leftrightarrow$$

$$0.002n - 12 = \frac{10^8}{(10^5 + n)^2} \Leftrightarrow n \approx 6004$$

The residents would lobby for 6004 homes compared to the 1005 homes in 110b.

111. (a) Denote the membership fee by F . With a constant $z = 1$, everyone in Lintukoto will be a customer if $v(n) = \sqrt{n} \geq F$ and otherwise no-one. This means that profit is maximized when $F = \sqrt{n}$. Since serving another customer does not cost anything to AllCaps, profits are maximized when everyone is a customer, i.e., when $F = \sqrt{10000} = 100$.
- (b) Since there are 10 000 people, with the lowest z at 0, the highest at 2 and an equal distance between each, the second highest z is $2 - \frac{2-0}{10000} = 2 - \frac{2}{10000}$, the third highest is $2 - 2 \times \frac{2}{10000}$ etc. In general, the preference parameter for the individual with the i th highest preference (starting the count from 0) is $z_i = 2 - \frac{i}{5000}$. Notice that with any fee that attracts some customers but not others, it will be the customers with the higher valuations (i.e. the higher zetas) that join the network. With n users, the lowest valuation included is $v(n) = (2 - \frac{n}{5000})\sqrt{n}$. The fee that gets n users to join is equal to the lowest valuation in that group, i.e. $F = v(n)$, and the revenue generated is

$$R(n) = nF = nv(n) = n(2 - \frac{n}{5000})\sqrt{n}$$

$$= 2n^{1.5} - \frac{n^{2.5}}{5000}$$

Marginal cost is zero, so profit maximization amounts to maximizing revenue. The first order condition is

$$3\sqrt{n} - \frac{2.5}{5000}n^{1.5} = 0 \implies \sqrt{n}\left(3 - \frac{2.5}{5000}n\right) = 0,$$

which is fulfilled either when $n = 0$ or $3 - \frac{2.5}{5000}n = 0 \implies n = 6000$. The latter is clearly the maximum, as $R(0) = 0$. With $n^* = 6000$, the lowest valuation, which equals the fee, is $v(n^*) = \left(2 - \frac{6000}{5000}\right)\sqrt{6000} = 0.8 \times \sqrt{6000} \approx 61.97$ euros.

- (c) Once FreeRant has enough customers AllCaps can no longer compete with price. Customers will find FreeRant preferable if AllCaps network has no more than n users, such that

$$\sqrt{n} < 2\sqrt{10000 - n} \implies n < 4 \times (10000 - n) \implies 5n < 40000 \implies n \leq 8000.$$

This is the tipping point: once FreeRant has attracted at least 2000 customers AllCaps can no longer survive in equilibrium. FreeRant can always match its subscription price and get all the 10 000 customers to itself.

Given that AllCaps has a fixed cost, in principle it could happen that it would be driven out of business before n reaches the tipping point. However, that is not the case here, as at the tipping point AllCaps still earns $8000v(8000) \approx 716$ k euros, much above the fixed cost 200k.

9 Information

112. (a) First, let's tabulate the productivity and outside options for each type:

	Productivity	Outside option 60%	Outside option 70%
High	1300	780	910
Median	600	360	420
Low	200	120	140

Firms don't know the diligence of applicants beforehand. They will offer the expected productivity to each applicant. First consider the case where everyone applies. The expected value for the firm is:

$$EV_{\text{all}} = \frac{1}{3}(1300 + 600 + 200) = 700$$

Compare this to the outside option of high diligence applicants: $EV_{\text{all}} = 700 < 780$. Since the wage offer would be smaller than the outside option, the high diligence technicians will be self-employed. If only median and low diligence technicians apply, $EV_{\text{median\&low}} = \frac{1}{2}(600 + 200) = 400$. With this wage offer, both types are hired by the firms. Average earnings are $\frac{1}{3}780 + \frac{2}{3}400 = 527$.

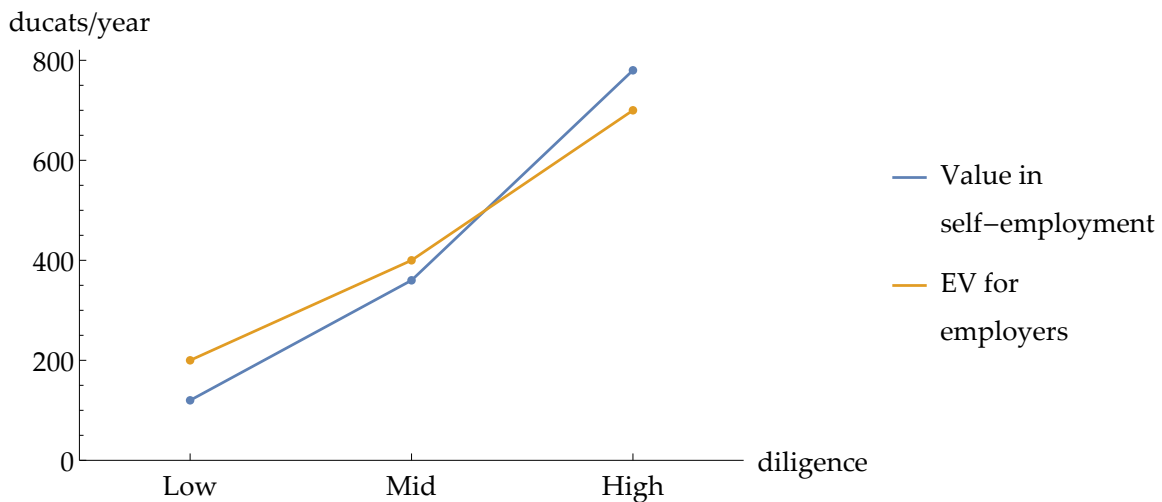

Figure 90: Adverse selection in problem 112a. “EV for employers” shows the expected worker productivity (and wage) if the worker type on horizontal axes and all lower types were pooled together. If a worker type can get a higher pay by “going it alone” in self-employment then this worker type will not in equilibrium accept employment in a firm. Here high diligence types will be self-employed in equilibrium.

Adverse selection causes a partial unraveling, because high type technicians opt out of the more productive employment due to asymmetric information. However, for the

median and lower types, the outside option is sufficiently low and their productivity sufficiently close to each other, so that even though firms undervalue the median types' productivity they can still offer a wage above what the median types would earn in self-employment.

- (b) This time the median type earns $420 > 400 = EV_{\text{median\&low}}$ in self-employment. Now firms cannot offer a wage high enough to attract median types. Adverse selection is in full effect and only “lemon” workers are left for firms to hire at wage 200. Average earnings are $\frac{1}{3}910 + \frac{1}{3}420 + \frac{1}{3}200 = 510$. Notice that, due to adverse selection, average earnings are now lower than in the case where workers were *more* productive in self-employment.

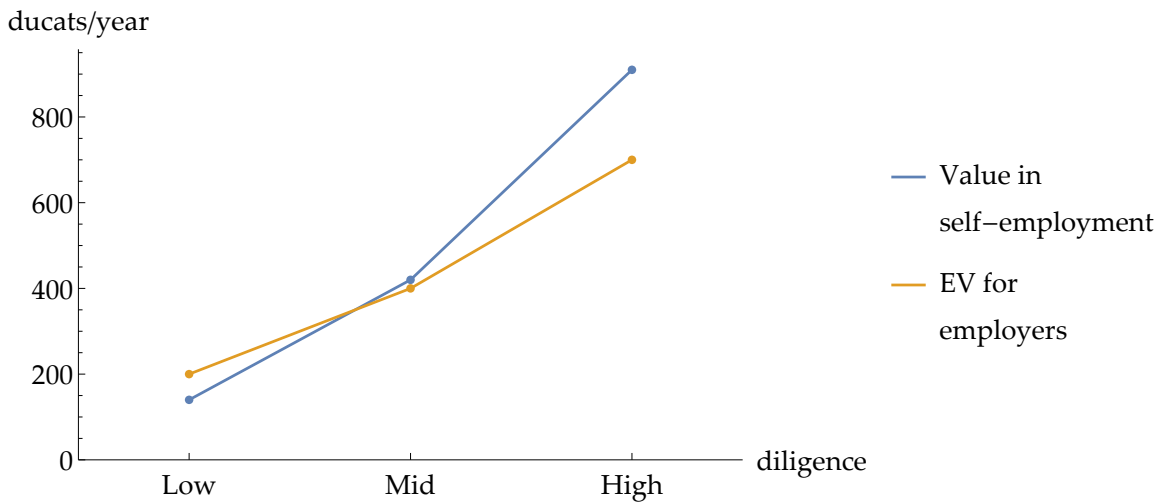

Figure 91: Similar to Figure 90, now productivity of self-employment has increased just enough to attract the middle-productivity type out of formal employment.

113. Let’s begin by summarizing the setup of the exercise. Since all customer types are equally common, we can consider a case where there is one customer of each type. The value of getting to destination is denoted by $\text{€}V$, which is at least $\text{€}150$ to all customers. A customer will buy the premium ticket if her expected value (EV) from it is at least as high as her expected value from the basic ticket. Let’s solve for the price of premium ticket that would lead to equal EVs for each of the three customer types:

Cancel. risk	EV_{basic}	EV_{premium}	$EV_{\text{basic}} = EV_{\text{premium}}$
15 %	$0.85 \text{€}V - 100 - 0.15 \times 20$	$0.85(\text{€}V - P_{\text{premium}})$	$P_{\text{premium}} \approx \text{€}121.2$
5 %	$0.95 \text{€}V - 100 - 0.05 \times 20$	$0.95(\text{€}V - P_{\text{premium}})$	$P_{\text{premium}} \approx \text{€}106.3$
1 %	$0.99 \text{€}V - 100 - 0.01 \times 20$	$0.99(\text{€}V - P_{\text{premium}})$	$P_{\text{premium}} \approx \text{€}101.2$

For the airline, the cost of providing the premium ticket is the expected refund, which is, for each of the customer types:

Cancel. risk	Exp. refund
15 %	$0.15 \times P_{premium}$
5 %	$0.05 \times P_{premium}$
1 %	$0.01 \times P_{premium}$

- (a) Since the premium ticket needs to be budget-neutral to the airline, the price of the premium ticket needs to be such that it exactly covers the expected refunds.

$$\frac{0.01 \times P_{premium} + 0.05 \times P_{premium} + 0.15 \times P_{premium}}{3} = P_{premium} - P_{basic} \Leftrightarrow$$

$$0.07 \times P_{premium} = P_{premium} - 100 \Leftrightarrow$$

$$P_{premium} \approx 107.53$$

At this price, neither the low-risk nor the medium-risk customers buy the premium ticket, since their valuation for the refund possibility is lower than the price differential between the basic and the premium ticket.

Thus only the high-risk customers buy the premium ticket. The budget neutral price is:

$$0.15 \times P_{premium} = P_{premium} - 100 \Leftrightarrow$$

$$P_{premium} \approx 117.6$$

This is lower than the high-risk customers' valuation for the premium ticket. Thus, they buy the premium ticket, while low- and medium-risk customers buy the basic ticket.

- (b) A profit-maximizing airline prices the premium ticket higher than the budget-neutral price. The high-risk customers buy the premium ticket as long as its price is not higher than their valuation for it. Thus, the profit-maximizing price for the premium ticket is 121.2 euros.

Low- and medium-risk customers buy the basic ticket, high-risk customers buy the premium ticket.

114. (a) If all four types of boats are sold, the buyers' expected value from buying a boat is $EV_4 = \frac{1}{4} \times (20 + 24 + 28 + 36) = 27$. But this is less than sellers' valuation for the perfect boats, and hence only three types of boats are traded. But this means that the buyers' expected values is only $EV_3 = \frac{1}{3} \times (20 + 24 + 28) = 24$, which is less than the sellers' valuation for good boats, which in turn means that only two types of boats are sold, leaving the buyers with an expected value of $EV_2 = \frac{1}{2}(20 + 24) = 22$. Since $EV_2 > 20$, the market doesn't unravel further, meaning that two types of boats, junk boats and fine boats are traded. The total number of boats traded is

$2 \times 1000/4 = 500$. Figure 92 shows this situation graphically, with the expected values of buyers when boat qualities up to a given type are on the market plotted with golden circles, and the sellers' valuations for the corresponding type plotted in blue.

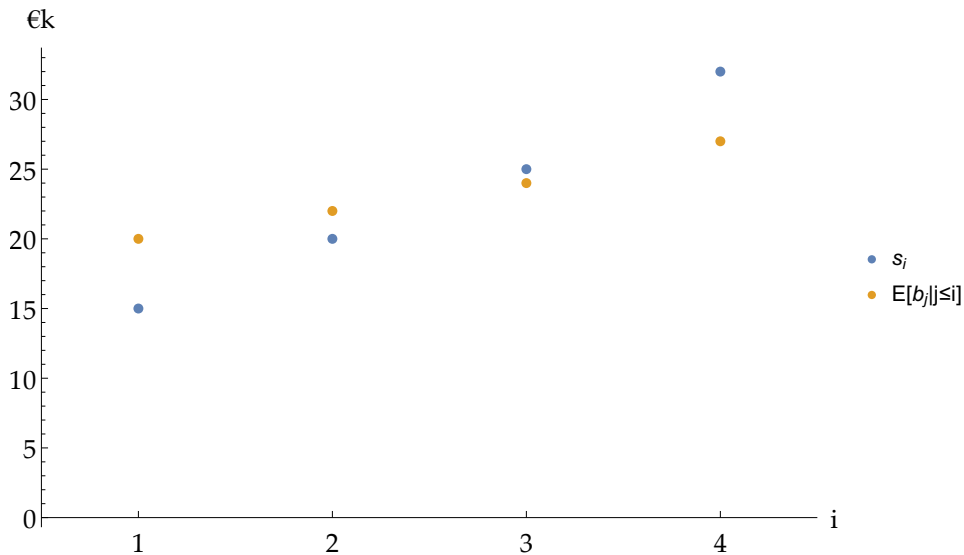

Figure 92: Valuation by seller type i is s_i , and expected buyer value if i is highest quality seller in the market is $E[b_j | j \leq i]$.

Since buyers value each boat type more than sellers, it would be efficient to trade all the boats. With symmetric information, the sellers would sell the boats at the buyers' valuations. This leaves all sellers better off by the difference in the valuations between them and the buyers, increasing total welfare by $250 \times (5 + 4 + 3 + 4) = 4000$ €k. With asymmetric information, only the fine and junk boat owners get to sell, and both sell at $EV_2 = 22$. This leaves junk sellers better off by 7, but also junk buyers worse off by 2. Both fine sellers and buyers meanwhile are left better off by 2. Thus total welfare increases by $250 \times (7 - 2 + 2 + 2) = 2250$ k€.

- (b) The dealer makes its profit by buying the boats at the sellers valuation or the price that the seller would get in the market, whichever is higher, and selling it forward to the customer at their valuation after credibly disclosing its quality. Note that if it didn't verify and disclose the quality of each boat it deals, it would just be buying and selling them at the market price and making zero profits. Since the dealer will verify the quality of a boat, it can make a contract with the seller where the price it pays for the boat is conditional on the quality. Also, note that the price the sellers can get in the market depends on what type of boats the dealer deals, since the types of boats dealt by the dealer are effectively out of the market.

Notice first that the dealer can never make a profit by dealing junk boats: the price their sellers get in the market is always at least equal to the buyer valuation.

Suppose then it only deals in perfect boats. Since the perfect boat sellers are not able to sell in the market, the dealer only needs to pay them their valuation, yielding it a profit of $36 - 32 - 2 = 2$ k€ per boat. Suppose next the dealer adds good boats to its repertoire. The good boat sellers are also unable to sell in the market with or without the dealer dealing in perfect boats. Hence, the dealer will make a profit of $28 - 25 - 2 = 1$ per good boat. Since this doesn't affect its ability to deal in perfect boats - the expected value of a boat in the market is still less than the perfect boat seller's valuation even if good boats are taken out of the mix - it should do both.

Should it also deal in fine boats? With only fine and junk boats in the market, the market price of 22 is still higher than the valuation of the fine boat sellers, so the dealer will need to pay that. This means that it will make $42 - 22 - 2 = 0$ €k profit from dealing in fine boats as well (obviously this doesn't affect its ability to deal in good or perfect boats because the market price would drop to the buyers' valuation of junk boats), making it indifferent between dealing and not dealing in them. Hence, there are two possibilities with different implications for total welfare:

(i) The dealer trades only in perfect and good boats, in which case they will sell at valuation while losing the verifying cost, while the payoffs for junk and fine types will be exactly as in the asymmetric information case of 114a. Taking into account the cost of verification, this yields a total welfare of $250 \times (4 - 2 + 3 - 2) + 2250 = 3000$ k€.

(ii) The dealer trades perfect, good and fine boats, leading to the symmetric information -situation from 114a, expect now 2k€ per boat is lost for perfect, good and fine boats, yielding a total welfare of $4000 - 750 \times 2 = 2500$. Hence, the former equilibrium yields a higher total welfare.

- (c) As long as the shares of junk and fine boats are equal, the expected value from buying in a market where only they are traded is the same. Hence, the market will never fully unravel regardless of the share of perfect types. However, if the share of perfect boats is high enough, there will be no unraveling at all, as the expected buyer value over all types then exceeds the highest seller valuation. With fraction x perfect types, the other three types will each have $(1 - x)/3$ of the total.

$$EV(x) = 36x + \frac{1-x}{3} \times (28 + 24 + 20) \geq 32$$

$$\implies 24 + 12x \geq 0 \implies x \geq \frac{2}{3}$$

Thus there is no unraveling if at least $2/3$ of boats are of perfect quality.

115. (a) The highly skilled chefs can benefit from signaling to potential customers that the cakes they made have indeed been made by highly skilled chefs, because that means

these are also guaranteed to be delicious. Since decorating a cake is less costly to them than the ordinary chefs, let's show that in equilibrium, the skilled chefs decorate their cakes and the ordinary ones don't.

To show this, let's first verify that ordinary chefs are better off by not decorating their cakes than by trying to imitate the highly-skilled chefs by decorating:

$$\begin{aligned} V_{\text{plain}} - \text{MC} &\geq V_{\text{delicious}} - \text{MC} - C_{\text{decoration}}^{\text{O}} \\ 10 - 5 &\geq 36 - 5 - 30 \\ 5 &\geq 1 \end{aligned}$$

Indeed, ordinary chefs get more profit by selling plain-looking, plain tasting cakes. This means that highly skilled chefs can signal their ability by decorating their cakes. Let's still verify that they earn more by decorating their cakes than by not decorating them:

$$\begin{aligned} V_{\text{delicious}} - \text{MC} - C_{\text{decoration}}^{\text{H}} &\geq E[V_{\text{cake}}] - \text{MC} \\ 36 - 5 - 10 &\geq \frac{36 + 10}{2} - 5 \\ 21 &\geq 18 \end{aligned}$$

Since ordinary chefs are better off by not decorating their cakes and highly skilled are better off by decorating their cakes, there is indeed an equilibrium in which cakes with complex decorations are delicious and plain-looking cakes taste plain.

- (b) The equilibrium breaks apart when ordinary chefs have an incentive to also start decorating their cakes. This happens, when:

$$\begin{aligned} V_{\text{plain}} - \text{MC} &< V_{\text{delicious}} - \text{MC} - C_{\text{decoration}}^{\text{O}} \\ 10 - 5 &< V - 5 - 30 \\ V &> 40 \end{aligned}$$

Since ordinary chefs have an incentive to start making complex decorations when buyer valuation for delicious cakes exceeds 40, highly skilled chefs cannot signal the superior taste of their products anymore. Decorating cakes becomes useless so nobody makes complex decorations anymore, buyers cannot distinguish between delicious and plain-tasting cakes and are willing to pay the expected value $\frac{V+10}{2}$ for any cake.

116. First, it is clear that the high types will never participate in the program. This is because the two lower types could always profitably "pretend" to be high types by paying the effort cost and taking the wage offer 1300 to the high types.

Consider an equilibrium candidate: High types choose outside option, median types complete the program and are hired by the firms, low types don't complete the program but are hired by the firms. In this case, the firms can distinguish between median and low types by observing the program completion. They offer 600 to the those who have completed the program (median) and 200 to those who haven't (low types). The median types' net benefit would be $600 - 450$, low types' 200 and high types 780. Does anyone have incentive to deviate?

If the median types don't complete the program, we are back to the case where they would earn 400 in the firm. Clearly $450 > 400$ so they don't have an incentive to deviate. The low type could try to pass for median a type by completing the program. They would gain $600 - 450 = 150 < 200$. This is not optimal either. Therefore, in the equilibrium high types would earn the same as before, median types would gain $450 - 400 = 50$ more and low types would gain $400 - 200 = 200$ less. The average earning stay the same at $\frac{1}{3}(780 + 600 + 200) = 527$ but the average surplus goes down: $\frac{1}{3}(780 + 450 + 200) = 477$. Notice that the average earning would go up if the proportion of median types was higher, since now they earn their productivity.

117. (a) The setup:

Share of workers	Productivity	Output value	Cost of education
1/2	High	$400 \times 7 = 2800$	$4200/7 = 600$
1/2	Low	$400 \times 2 = 800$	$4200/2 = 2100$

Since the equilibrium earnings leave zero expected profits to employers, wages equal to the expected output value of a prospective worker. Let's check whether the following wages would lead to an equilibrium, where high productivity Woebegonians get a college degree and low productivity residents don't:

$$Wage_{college} = Output_{high} = 2800$$

$$Wage_{nocollege} = Output_{low} = 800$$

High productivity residents get a college degree, because $2800 - 600 > 800$. Low productivity residents don't get a degree, because $2800 - 2100 < 800$. Thus, there indeed is an equilibrium where some residents get a college degree and some don't.

(b) College degree becomes useless if it doesn't distinguish between high and low productivity residents. This happens if low productivity residents will also find it profitable to get a degree:

$$Wage_{college} - Cost_{college}^L \geq Wage_{nocollege} \Rightarrow$$

$$2800 - c/2 \geq 800$$

$$c \leq 4000$$

In this situation, high and low productivity workers would get the same wage, equalling expected output: $0.5 \times 2800 + 0.5 \times 800 = 1800$ MUs.

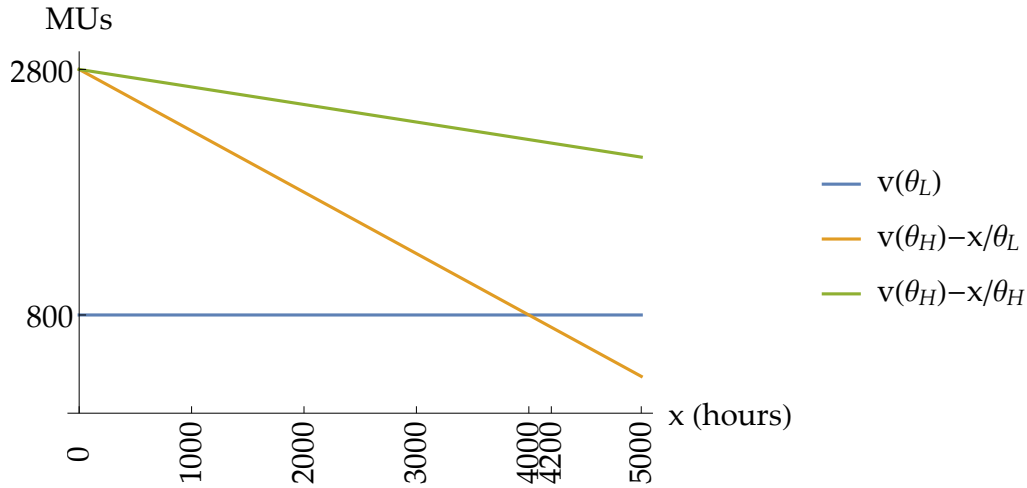

Figure 93: Payoffs from getting a degree as a function of studying hours

(c) The setup is now:

Share of workers	Productivity	Output value	Cost of education
1/3	High	$400 \times 7 = 2800$	$4200/7 = 600$
1/3	Mid	$400 \times 5 = 2000$	$4200/5 = 840$
1/3	Low	$400 \times 2 = 800$	$4200/2 = 2100$

Let's check whether it is possible to:

i.) set a wage where only high productivity types get a college degree. In this case, the wages would be:

$$Wage_{college} = Output_{high} = 2800$$

$$Wage_{nocollege} = 0.5 \times Output_{low} + 0.5 \times Output_{mid} = 1400$$

High productivity residents get a college degree, because $2800 - 600 > 1400$. Mid productivity residents will also get a degree, because $2800 - 840 > 1400$. Thus, there is no equilibrium where only high productivity workers get a degree.

ii.) set a wage where high and mid productivity types get a college degree. The wages would be:

$$Wage_{college} = 0.5 \times Output_{high} + 0.5 \times Output_{mid} = 2400$$

$$Wage_{nocollege} = Output_{low} = 800$$

High and mid productivity workers get a degree, since the wage difference exceeds the cost of education. Low productivity workers don't get a degree, because $2400 - 2100 < 800$.

118. (a) The efficient amount of care maximizes the joint surplus of the consumer and the producer. The surpluses are:

$$CS(c) = V_{\text{gadget}} - p_{\text{gadget}} - c = 100 - p - c$$

$$PS(c) = p_{\text{gadget}} - C_{\text{gadget}} - C_{\text{gadget}} \times Pr(\text{broken gadget}) = p - 64 - 64 \times \frac{1}{c}$$

$$TS(c) = CS(c) + PS(c) = 36 - c - 64 \times \frac{1}{c}$$

Let's differentiate $TS(c)$ wrt. c to get the optimal amount of care:

$$\begin{aligned} \frac{\partial TS(c)}{\partial c} &= -1 + \frac{64}{c^2} = 0 \\ \implies c^* &= 8 \end{aligned}$$

The efficient amount of care is €8.

- (b) Since the consumer is fully insured against breaking the gadget, there is a problem of moral hazard and it is optimal for the consumer to expend zero euros worth of care. Thus, the probability of the gadget breaking down is $1/2$. Let's solve for the firm's break-even price:

$$\begin{aligned} PS(c) &= p - 64 - \frac{64}{2} = 0 \\ \implies p^* &= 96 \end{aligned}$$

The break-even price is €96.

- (c) As in part 118a, we are maximizing the sum of consumer and producer surplus. The surpluses are:

$$CS(x, c) = 100 - p - c - x \times \frac{1}{c}$$

$$PS(c) = p - 64 - 64 \times \frac{1}{c}$$

$$TS(x, c) = 36 - c - 64 \times \frac{1}{c} - x \times \frac{1}{c}$$

The expression for $TS(x, c)$ can be simplified to a function that depends only on c , since whatever the hassle cost x , the consumer will choose c optimally so that the cost of care equals the expected hassle cost: $c = \frac{x}{c}$. Then, we can optimize:

$$\begin{aligned} TS(c) &= 36 - 2c - \frac{64}{c} \\ \frac{\partial TS(c)}{\partial c} &= -2 + \frac{64}{c^2} = 0 \\ \implies c^* &= \sqrt{32} \end{aligned}$$

Since $c = \frac{x}{c}$ and $c^* = \sqrt{32}$, the welfare-maximizing hassle is $x = 32$. The lowest break-even price for gadgets is:

$$PS(c) = p - 64 - \frac{64}{\sqrt{32}} = 0$$

$$\implies p^* \approx \text{€}75.31$$

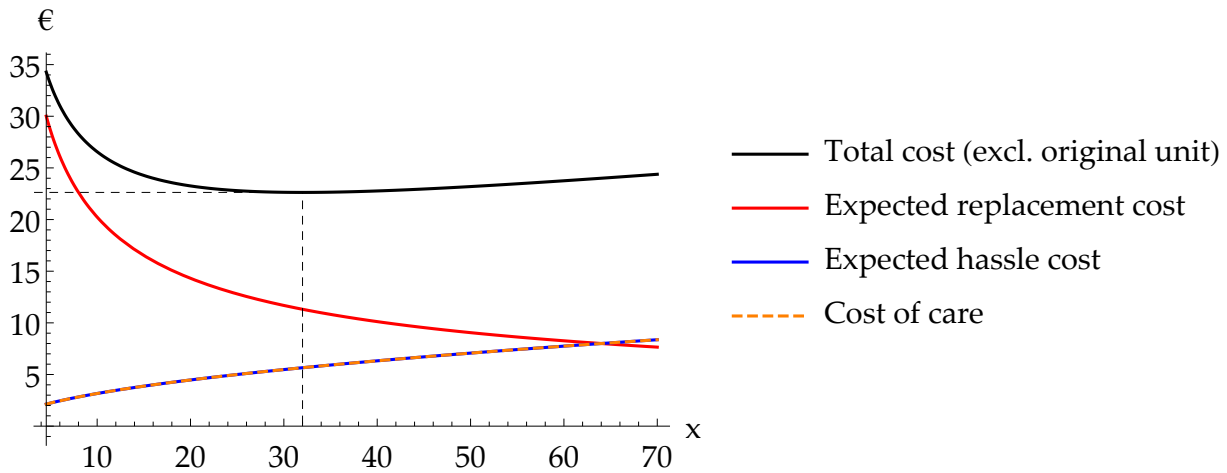

Figure 94: Firm’s replacement costs and consumer’s hassle and care costs as a function of hassle cost

119. (a) Denote the deductible with D . The expected utility for drivers is given by:

$$EV(\text{careless}) = 3000 - 0.16D$$

$$EV(\text{careful}) = -0.04D$$

D must satisfy $EV(\text{careless}) < EV(\text{careful})$ for drivers to choose careful driving:

$$3000 - 0.16D < -0.04D$$

$$D > 25000$$

The break-even price of the insurance corresponds to the expected insurance payout given the careful driving incentivized by the deductible:

$$P = 0.04(30000 - 25000) = 200$$

(b) In this case the driver will be careless. The expected payout is $0.16 \times 30000 = 4800$.

(c) Now the inequality becomes:

$$3000 - \sqrt{0.16}D < -\sqrt{0.04}D$$

$$D > 15000$$

The break-even price is: $P = 0.04(30000 - 15000) = 600$

120. (a) The efficient level of spending minimizes expected loss $\mathbb{E}L(x, v) = p(x)v + x$, where $x \in \{0, 1, 2, 4\}$ is a possible level of spending, $p(x)$ is the associated probability of total loss, and v is the level of total loss (i.e., the value of the ship and the cargo). Plugging in the possible levels of spending yields:

$$\begin{aligned}\mathbb{E}L(0, v) &= 0.2v \\ \mathbb{E}L(1, v) &= 0.08v + 1 \\ \mathbb{E}L(2, v) &= 0.04v + 2 \\ \mathbb{E}L(4, v) &= 0.01v + 4\end{aligned}$$

Evaluating these for a low value ship ($v = 20$) yields the expected losses $\{4, \underline{2.6}, 2.8, 4.2\}$. Likewise, for a high-value ship ($v = 100$) the expected losses are $\{20, 9, 6, \underline{5}\}$. The optimal level of safety spending is €1 million for a low-value ship, and €4 million for a high-value ship.

Minimizing expected loss is, of course, equivalent with maximizing expected profits $\mathbb{E}\Pi(x, v) = v - L(x, v)$ and would lead to the same conclusions.

- (b) With an insurance plan with a coinsurance rate r the expected loss is $\mathbb{E}L_I(x, v, r) = p(x)vr + x$. The insurance premium is a sunk cost from the point of view of the insurees, and can therefore be ignored in their choice of safety spending. Note that spending $x = 0$ on safety is not an options, since Acme requires and can verify that the first million be speng. Plugging in the possible levels of spending and Acme's coinsurance rate $r = 0.35$, we get:

$$\begin{aligned}\mathbb{E}L_I(1, v, 0.35) &= 0.028v + 1 \\ \mathbb{E}L_I(2, v, 0.35) &= 0.014v + 2 \\ \mathbb{E}L_I(4, v, 0.35) &= 0.0035v + 4\end{aligned}$$

Evaluating these at the two ship values yields expected losses of $\{\underline{1.56}, 2.28, 4.07\}$ for low-value and $\{3.8, \underline{3.4}, 4.35\}$ for high-value ships. With these coinsurance rates low-value shipowners will spend the verifiable €1 million, which suffices for efficiency. Owners of high-value shipowners spend less than the efficient amount, €2 million.

An actuarially fair insurance charges the expected value of payouts. For a low-value ship it is $0.08 \times (1 - 0.35) \times 20 = 1.04$ million, and for a high-value ship $0.04 \times (1 - 0.35) \times 100 = 2.6$ million.

As a side note, if the shipowners are risk neutral, they would not benefit even from actuarially fair insurance. For this question risk neutrality was a mathematical simplification, but in practice there exist also regulatory requirements for obtaining insurance coverage.

- (c) It is useful to notice that the incentive to spend on safety is increasing in the coinsurance rate as well as in the value of the ship. Also it is never a worry that an insuree would spend too much on safety—the whole problem of insufficient unverifiable safety spending is a moral hazard problem caused by insurance.

For low-value shipowners the verifiable spending i.e. the “first million”, is the efficient level, so any coinsurance rate including zero will do. We saw in part 120b that the high-value shipowners spend at the second highest level (€2m) at coinsurance rate $r = 0.35$, so the only question is which rate $r > 0.35$ (if any) is sufficiently high to motivate them to spend €4m instead. In terms of the expected loss, the question is then which r is high enough to make the following inequality true: $\mathbb{E}L_I(4, 100, r) \geq \mathbb{E}L_I(3, 100, r)$. The threshold r is found by solving the associated equality: $0.01 \times 100r + 4 = 0.04 \times 100r + 2 \implies r = 2/3$. A coinsurance rate of 66.7 would be needed for high value ship owners to spend enough on safety.

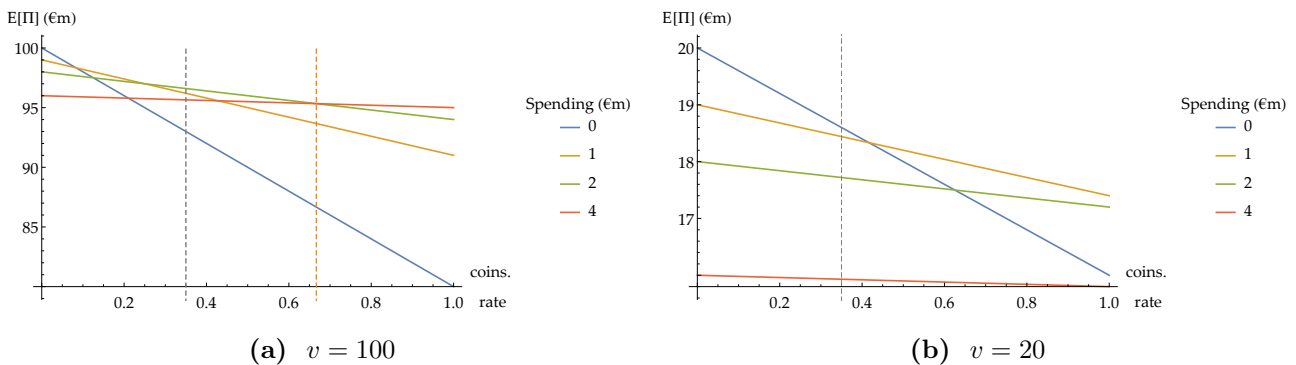

Figure 95: Expected profits at various levels of safety spending as a function of the coinsurance rate.

- (d) The question is which shipowner value \bar{v} would be high enough to guarantee an efficient level of safety spending at all values greater than \bar{v} when coinsurance rate is $r = 0.35$. We already saw that $v = 100$ was not high enough. Since both optimal and voluntary safety spending are increasing in v , the threshold case will have $x = 4$ as the optimal level. The binding constraint is that a shipowner with value \bar{v} finds it just optimal to spend $x = 4$ rather than the next highest $x = 2$. In other words, the inequality $\mathbb{E}L_I(4, v, 0.35) \geq \mathbb{E}L_I(3, v, 0.35)$ will hold as an equality at \bar{v} . Plugging in the definitions this amounts to $0.01 \times 0.35\bar{v} + 4 = 0.04 \times 0.35\bar{v} + 2 \implies \bar{v} \approx 190$ €m.

121. (a) The efficient level of effort maximizes the output of Raymond’s work minus possible costs to Raymond. With low effort, it is clearly best that Raymond works for the other company and makes €100k, since with low effort, the probability of sales is zero. With high effort, working for Öky-Alus, the expected value of Raymond’s work

is:

$$EV_{\text{high}} = 0.8 \times 1000 - 40 = \text{€}760\text{k}$$

Since this is more than the €100k that Raymond currently makes with low effort, high effort is economically efficient.

- (b) Since Raymond is risk-neutral, he compares expected payoffs. The pay package needs to satisfy two criteria. Firstly, it must incentivize Raymond to exert high effort at work. Secondly, It must give a higher expected compensation to Raymond than the outside option of €100k. Let's first solve for the sales bonus that would make high effort optimal for Raymond:

$$\begin{aligned} EV_{\text{high}} &\geq EV_{\text{low}} \\ x + 0.8b - 40 &\geq x \\ b &\geq 50 \end{aligned}$$

The bonus needs to be at least €50k to incentivize high effort. Let's then solve for the smallest base wage that would make Raymond work for Öky-Alus:

$$\begin{aligned} x + 0.8 \times 50 - 40 &\geq 100 \\ x &\geq 100 \end{aligned}$$

The base wage needs to be at least €100k if bonus is €50k. There are many other combinations of base wage and bonus that would maximize the profits of Öky-Alus and incentivize Raymond to work for Öky-Alus, but $x = 100$ and $b = 50$ is the solution with the highest base wage. Clearly, expected profits are also above zero.

- (c) Let's start by expressing Raymond's utility when he gets a bonus (v_2) and when he doesn't (v_1):

$$\begin{aligned} v_1 &= u(x + w_0) = (x + 116)^{2/3} \\ v_2 &= u(x + b + w_0) = (x + b + 116)^{2/3} \end{aligned}$$

Raymond is now risk averse, but the pay package still needs to satisfy the same two criteria as in part 121b. Let's use the expressions from above and formulate the conditions. 1.) The bonus needs to be high enough to incentivize high effort:

$$\begin{aligned} EV_{\text{high}} &\geq EV_{\text{low}} \\ 0.8v_2 + 0.2v_1 - 40 &\geq v_1 \\ v_2 &\geq v_1 + 50 \end{aligned}$$

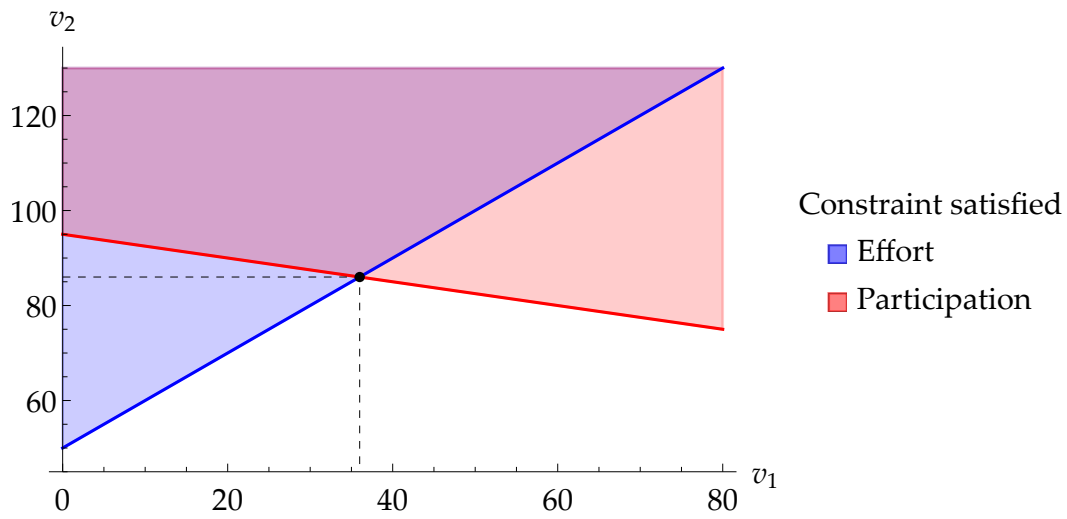

Figure 96: Participation (work for Öky-Alus) and effort (exert high effort) constraints of Raymond, in terms of the transformed variables v_1 and v_2 in part 121c.

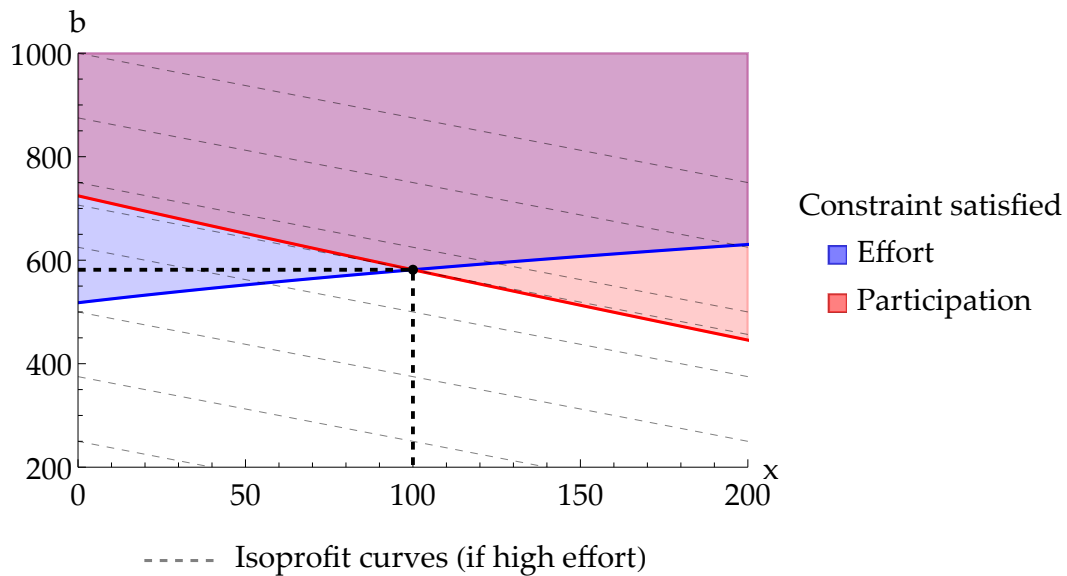

Figure 97: Participation and effort constraints in terms of base wage x and bonus b (in €) in part 121c.

2.) The overall payoff (with high effort) needs to be higher than at the other firm:

$$0.8v_2 + 0.2v_1 - 40 \geq (100 + 116)^{2/3}$$

$$0.8v_2 + 0.2v_1 - 40 \geq 36$$

Let's plug the v_2 solved from the first condition into the second condition and solve for the optimal base wage:

$$\begin{aligned} 0.8(v_1 + 50) + 0.2v_1 - 40 &\geq 36 \\ v_1 &\geq 36 \\ (x + 116)^{2/3} &\geq 36 \\ x &\geq 100 \end{aligned}$$

Thus, the optimal base wage is 100. Let's then plug this into the first first condition and solve for the optimal bonus:

$$\begin{aligned} v_2 &\geq v_1 + 50 \\ (100 + b + 116)^{2/3} &\geq 86 \\ 100 + b + 116 &\geq 797.53 \\ b &\geq 581.53 \end{aligned}$$

The optimal base wage is €100k and the optimal bonus €581.53k. Let's verify that expected profits are above zero:

$$E[\Pi(x = 100, b = 581.53)] = 0.8(1000 - 581.53) - 100 = 234.78.$$

Expected profits are €234.78k, so this indeed is the profit-maximizing pay package. *Additional comment.* There is no need to check whether any other point that satisfies both constraints could give higher expected profits to the employer. The employer could offer a contract that is to the left on the participation constraint in Figure 97, while still eliciting high effort. However, this would involve exposing the worker to more risk (due to lower base wage, higher bonus) while giving the same expected utility—for which the risk averse worker has to be compensated with a risk premium. At the optimal point the employer is assuming as much risk as possible while both constraints are still satisfied for the worker.

122. (a) In a second-price procurement auction, the lowest bidder wins and gets the second-lowest bidder's price for completing the project. The dominant strategy is to bid your valuation. Thus, Asfaltti Oy should bid €3 billion for the project.

To see why, consider first a case where Asfaltti Oy would bid below €3 billion. This would not increase its probability of winning if Raxa Group's bid is above €3 billion. And if Raxa Group's bid is below €3 billion and Asfaltti Oy won, it would make a loss. Bidding above €3 billion is not optimal either, since then Asfaltti Oy would lose some of the auctions that would have been profitable for it. Conditional on Asfaltti Oy winning the auction, bidding above €3 billion would also not result in

more profit from the project, since the procurement price is defined by Raxa Group's losing bid.

- (b) Now the situation is trickier, since bidding your valuation is generally not the optimal strategy in a first-price auction. Asfaltti Oy must balance the probability of winning (increases with a lower bid) and the profit from the project, conditional on winning (increases with a higher bid). Asfaltti Oy knows that Raxa's bids are uniformly distributed between €1.25 billion and €5 billion. The expected profit of Asfaltti Oy is:

$$\begin{aligned} E[\pi_A(b)] &= \underbrace{\Pr(b \leq b_R)}_{\text{Prob. that bid under Raxa's}} \times \underbrace{(b - 3)}_{\text{Profit, if win}} \\ &= (1 - F_R(b))(b - 3) \\ &= \left(1 - \frac{b - 1.25}{5 - 1.25}\right)(b - 3) \\ &= \frac{(5 - b)(b - 3)}{3.75} \end{aligned}$$

The optimal bid is then:

$$\begin{aligned} \frac{\partial E[\pi_A(b)]}{\partial b} &= \frac{8 - 2b}{3.75} = 0 \\ \implies b &= 4 \end{aligned}$$

The optimal bid for Asfaltti Oy is €4 billion.

- (c) In a second-price auction, finding out Raxa's exact cost would not benefit Asfaltti Oy, since knowing the costs would not alter Asfaltti's optimal bid. Asfaltti will win the auction and get the project at Raxa's bid if Raxa's bid is above €3 billion and lose the auction if Raxa's bid is below €3 billion.

In a first-price auction, the situation is different. With the information, Asfaltti will be able to win all auctions where winning is profitable (ie. Raxa's bid is above €3 billion) by bidding slightly below Raxa's bid ($b = b_R - \epsilon$):

$$E[\pi_A(b = b_R - \epsilon)] = \underbrace{\Pr(b_R \geq 3)}_{\text{Prob. that Raxa's bid over €3B}} \times \underbrace{E[\pi_A(b = b_R - \epsilon) | b_R \geq 3]}_{\text{Expected profit with optimal bid}}$$

The probability that Raxa's bid is above €3B is $1 - F_R(3) = 1 - \frac{3-1.25}{5-1.25} = 53.33\%$. Since bids above €3B by Raxa are uniformly distributed, Raxa's expected bid, conditional on the bid being above €3B, is €4B. Thus, $E[\pi_A(b = b_R - \epsilon)] = 0.5333 \times (4 - 3) \approx 0.53$ billion euros.

To determine how much the information is worth, let's compare these profits to the expected profits without full information about Raxa's costs:

$$E[\pi_A(b)] = \frac{(5-b)(b-3)}{3.75}$$

$$\implies E[\pi_A(4)] = \frac{(5-4)(4-3)}{3.75} = \frac{1}{3.75} \approx 0.267$$

The value of the information is $0.533 - 0.267 \approx 0.27$ billion euros.

123. The demand functions for the two schools are:

$$\text{East side} \begin{cases} P_E^d(Q) &= 11 - \frac{Q}{100} \Leftrightarrow \\ Q_E^d(P) &= 1100 - 100P \end{cases}$$

$$\text{West side} \begin{cases} P_W^d(Q) &= 21 - \frac{Q}{100} \Leftrightarrow \\ Q_W^d(P) &= 2100 - 100P \end{cases}$$

- (a) The photographer is essentially bidding for the right to be the monopolist in the class photo market at the two schools. To solve for the optimal bid, let's solve for the monopoly profits at both schools:

$$\text{East side} \left\{ \begin{array}{l} \Pi_E(P) = (1100 - 100P) \times P - (1100 - 100P) \times 3 - 1000 \\ = 1100P - 100P^2 - 3300 + 300P - 1000 \\ = -100P^2 + 1400P - 4300 \\ \text{Solve for optimal P:} \\ \frac{\partial \Pi_E(P)}{\partial P} = -200P + 1400 = 0 \Leftrightarrow \\ P^* = 7 \\ \text{Solve for optimal Q:} \\ Q^* = 1100 - 100 \times 7 = 400 \\ \text{Calculate optimal profits:} \\ \Pi_E(P^*, Q^*) = 400 \times (7 - 3) - 1000 = 600 \end{array} \right.$$

$$\text{West side} \left\{ \begin{array}{l} \Pi_W(P) = (2100 - 100P) \times P - (2100 - 100P) \times 3 - 1000 \\ = 2100P - 100P^2 - 6300 + 300P - 1000 \\ = -100P^2 + 2400P - 7300 \\ \text{Solve for optimal P:} \\ \frac{\partial \Pi_W(P)}{\partial P} = -200P + 2400 = 0 \Leftrightarrow \\ P^* = 12 \\ \text{Solve for optimal Q:} \\ Q^* = 2100 - 100 \times 12 = 900 \\ \text{Calculate optimal profits:} \\ \Pi_W(P^*, Q^*) = 900 \times (12 - 3) - 1000 = 7100 \end{array} \right.$$

In a second-price auction, the dominant strategy is to bid one's valuation. The optimal bids are thus €600 for East Side school and €7100 for West Side school.

- (b) Now it is optimal for the photographer to set the bid to the point where she makes zero profits.

$$\text{East side} \left\{ \begin{array}{l} \Pi_E(P) = -100P^2 + 1400P - 4300 = 0 \implies P^* \approx 4.56 \\ \text{With this price, quantity is} \\ Q^* = 1100 - 100 \times 4.56 = 644 \end{array} \right.$$

$$\text{West side} \left\{ \begin{array}{l} \Pi_W(P) = -100P^2 + 2400P - 7300 = 0 \implies P^* \approx 3.58 \\ \text{With this price, quantity is} \\ Q^* = 2100 - 100 \times 3.58 = 1742 \end{array} \right.$$

The optimal bids are €4.56 for East Side school and €3.58 for West Side school. Of course she will hope to do better than this, but this is the reservation price, and hence the optimal bid in the second price auction.

- (c) It is optimal for the photographer to set the bid so that it equals her profits with the fixed price $P = 5$:

$$\text{East side} \left\{ \begin{array}{l} \Pi_E(5) = -100 \times 5^2 + 1400 \times 5 - 4300 = 200 \\ \text{With this price, quantity is} \\ Q^* = 1100 - 100 \times 5 = 600 \end{array} \right.$$

$$\text{West side} \left\{ \begin{array}{l} \Pi_W(5) = -100 \times 5^2 + 2400 \times 5 - 7300 = 2200 \\ \text{With this price, quantity is} \\ Q^* = 2100 - 100 \times 5 = 1600 \end{array} \right.$$

The optimal bids are €200 for East Side school and €2200 for West Side school.

(d) Let's summarize the buyer side surplus for the different procurement rules:

East Side school			
	School revenue	Consumer Surplus $(P_E^d(0) - P)Q/2$	Buyer side surplus
Part 123a	600	$(11 - 7) \times 400/2 = 800$	€1400
Part 123b	0	$(11 - 4.56) \times 644/2 = 2073.68$	€2073.68
Part 123c	200	$(11 - 5) \times 600/2 = 1800$	€2000

West Side school			
	School revenue	Consumer Surplus $(P_W^d(0) - P)Q/2$	Buyer side surplus
Part 123a	7100	$(21 - 12) \times 900/2 = 4050$	€11150
Part 123b	0	$(21 - 3.58) \times 1742/2 = 15172.82$	€15172.82
Part 123c	2200	$(21 - 5) \times 1600/2 = 12800$	€15000

In both cases, buyer surplus is maximized when bidding is for the price of individual photos. This procurement rule also leads to the highest number of photos taken.

124. (a) The auction can be interpreted as a simultaneous game. Both players have a valuation drawn from a uniform distribution between 0 and 300. Their tastes are independent and they know their own valuation but not that of their rival.

In a first-price auction, the rival bids half their valuation, so their bid is uniformly distributed between 0 and 150. If your bid b is higher than the rival's, you earn $v - b^*$ in which v is your valuation and b is your bid. If you lose the auction, you get nothing. Your probability of winning the auction is

$$P(b) = \begin{cases} 1 & \text{if } b > 150 \\ \frac{b}{150} & \text{if } b \in [0, 150] \end{cases}$$

Clearly it never makes sense to bid over 150 because 150 guarantees a win with probability 1. (Ties can be ignored: the probability of a tie is zero because valuations are drawn from a continuous distribution.) Your expected profits from bidding b are

$$E[\pi(b)] = P(b)\pi(b) = \frac{b}{150}(v - b) = \frac{vb - b^2}{150}$$

Let's take the first-order condition, and then solve it for the optimal bid.

$$\frac{\partial E[\pi(b)]}{\partial b} = \frac{v - 2b}{150} = 0 \implies b^*(v) = \frac{1}{2}v$$

If your rival bids half their valuation you should also bid half your valuation.

- (b) Because the rival knows that you have the same valuation distribution as they and they believe that you are using the same strategy as you believed they were following in 124a, they are in exactly the same situation as you were in part 124a. Hence the rival's optimal strategy must be the same: it is optimal to bid half the valuation, $B^*(V) = V/2$.

Comment: Notice that we have now found the equilibrium of this game (although this was not asked for in the question): both players bid half their valuation. In this case we found it by making a guess about a strategy for one player; then showing that it is optimal for both players to stick to this strategy.¹⁸

- (c) If both players bid half their valuation, the seller earns half of the valuation of the player with higher valuation. Because the valuations (and therefore the bids) are independent, the cumulative probability distribution of the seller's profit (= the valuation of the player with higher valuation) is

$$\begin{aligned} P(\pi_s \leq b_{\max}) &= P(\pi_s \leq b_1) \times P(\pi_s \leq b_2) = \frac{b_1}{150} \frac{b_2}{150} \\ &= \frac{\frac{1}{2}v_1}{150} \frac{\frac{1}{2}v_2}{150} = \frac{v_1 v_2}{300^2} = \left(\frac{v}{300}\right)^2 = F_{\max}(v) \end{aligned}$$

In which π_s is the seller's revenue, b_{\max} is the highest bid, b_1 and b_2 are the bids and v_1 and v_2 are the valuations of the respective players, and because v_1 and v_2 follow the same distribution, we denote the product as v^2 .

Hence, the probability distribution function is

$$\frac{dF_{\max}(v)}{dv} = \frac{2v}{300^2} = f_{\max}(v)$$

Now, using the probability distribution function of the maximum valuation (and subsequently the maximum bid) and the knowledge that the bids are half of the valuation, we calculate the expected value of the maximum bid

$$\int_0^{300} \frac{1}{2}v \frac{2v}{300} dv = \int_0^{300} \frac{v^2}{300^2} dv = \frac{1}{3}(300 - 0) = 100$$

Thus, the seller's expected revenue is 100 euros.

- (d) In a second price auction, it is optimal to bid your own reservation value. Knowing that both players will bid equal to their valuation, i.e., $\hat{b}(v) = v$, the seller's revenue

¹⁸More generally, instead of having to make a "lucky guess", the equilibrium can be solved directly for any distribution of valuations and any number of bidders. To see how, see the lecture notes on Microeconomics of Pricing (31E11100) by Pauli Murto: https://mycourses.aalto.fi/pluginfile.php/2142979/mod_resource/content/1/Handout%20Part4.pdf.

will be equal to the lower valuation. The cumulative distribution function of a minimum valuation of two valuations is now

$$F_{\min}(v) = 1 - \left(1 - \frac{v}{300}\right)^2 = \frac{300^2 - 300^2 + 600v - v^2}{300^2} = \frac{600v - v^2}{300^2}$$

Hence, the probability distribution function is

$$\frac{dF_{\min}(v)}{dv} = f_{\min}(v) = \frac{600 - 2v}{300^2}$$

Hence, the expected seller's revenue is

$$\begin{aligned} \int_0^{300} v \frac{600 - 2v}{300^2} dv &= \int_0^{300} \frac{600v - 2v^2}{300^2} dv = \frac{\frac{1}{2}600 \times 300^2 - \frac{2}{3}300^3}{300^2} - \frac{0}{300^2} \\ &= 300 - \frac{2}{3}300 = 100 \end{aligned}$$

That is, the seller's expected revenue is 100 euros which is equal to the revenue in a first price auction in question 124c. This is not a coincidence, but rather a consequence of the Revenue Equivalence Theorem. Basically, the buyers have valuable private information about their own valuations, and the seller cannot extract more of that value merely by changing what the bidders are asked to report.

125. (a) Since the valuations are uniformly distributed, each valuation between 0 and 200 euros is equally likely for Hanne (buyer) and each valuation between 0 and 100 euros is equally likely for Jonne (seller).

For trade to be efficient, buyer valuation needs to be at least as high as seller valuation. When buyer valuation is above 100, trade is always efficient. This happens 50% of the time. When buyer valuation is below 100, trade is efficient half the time. Thus, with $50\% \times 1 + 50\% \times 0.5 = 75\%$ probability, trade would be efficient.

- (b) When buyer makes the TIOLI offer, the expected profit function and optimal price is:

$$\begin{aligned} \pi_b(p) &= (b - p)\Pr(s \leq p) = (b - p)p \\ \frac{\partial \pi_b(p)}{\partial p} &= b - 2p = 0 \implies \\ p_b(b) &= \frac{b}{2} \end{aligned}$$

Since buyer valuation b is uniformly distributed between 0 and 200 euros, the price $p_b(b)$ is uniformly distributed between 0 and 100 euros. And since seller valuation is also uniformly distributed between 0 and 100 euros, trade happens with 50% probability.

(c) When seller makes the TIOLI offer, the expected profit function and optimal price is:

$$\begin{aligned} \pi_s(p) &= (p - s)\Pr(b \geq p) = (p - s)\left(1 - \frac{p - 0}{200 - 0}\right) \\ &= (p - s)\left(\frac{200 - p}{200}\right) \\ \frac{\partial \pi_s(p)}{\partial p} &= \frac{200 - 2p + s}{200} = 0 \implies \\ p_s(s) &= \frac{200 + s}{2} \end{aligned}$$

Seller valuation is between 0 and 100 euros. When seller valuation is 0, the optimal price is $\frac{200+0}{2} = 100$, and trade occurs 50% (probability that buyer value is above 100) of the time. When seller valuation is 100, the optimal price is $\frac{200+100}{2} = 150$, and trade occurs 25% of the time. Since the price is uniformly distributed between 100 and 150 euros, trade occurs $\frac{50\%+25\%}{2} = 37.5\%$ of the time, when seller makes the TIOLI offer.

Possible reservation values (€)

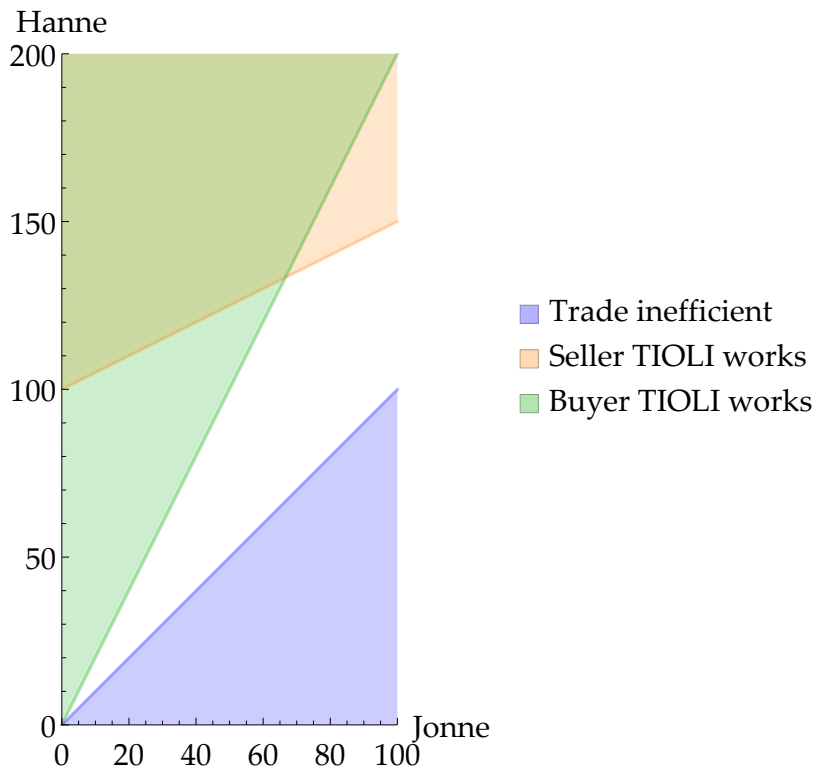

Figure 98: The green and orange lines show the optimal buyer and seller TIOLI prices as functions of buyer and seller valuations in parts 125c and 125c. The blue area shows where seller valuation is above buyer valuation, and thus trade is inefficient. In the white area, trade doesn't occur even though it would be efficient.

126. The setup is:

€k / year	Value	Surplus	Report
Atte	$V_A = 35$	$S_A = 15$	Z_A
Bette	$V_B = 18$	$S_B = -2$	Z_B
Citte	$V_C = 14$	$S_C = -6$	Z_C

- (a) When owners use majority voting, only Atte votes for the swimming pool, since he's the only one who would get a positive surplus. The swimming pool will not be built, total payments and individual surpluses are zero.
- (b) The aggregate surplus from building the swimming pool is $15 - 2 - 6 = 7$ thousand euros. Thus, the welfare maximizing decision is to build the swimming pool. If the surplus is divided equally, each inhabitant gets $7/3$ thousand euros in surplus. The payments P in thousands that implement this are the following:

$$P_A = 35 - x = \frac{7}{3} \Leftrightarrow x = \frac{98}{3} \approx 32.67$$

$$P_B = 18 - y = \frac{7}{3} \Leftrightarrow y = \frac{47}{3} \approx 15.67$$

$$P_C = 14 - z = \frac{7}{3} \Leftrightarrow z = \frac{35}{3} \approx 11.67$$

(You could equivalently define the payments as on top of the cost share, in which case subtract 20 from each of these values.) In other words, Atte subsidizes the other two owners, since they pay less than 20 thousand euros and Atte pays more than 20 thousand euros for the swimming pool.

- (c) Let's check whether some of the owners are pivotal:

$$Z_A + Z_B + Z_C = 15 - 2 - 6 = 7 > 0 \Rightarrow \text{decision is "build"}$$

$$Z_B + Z_C = -2 - 6 = -8 < 0 \Rightarrow \text{Atte is pivotal, pays tax } T_A = 8$$

$$Z_A + Z_C = 15 - 6 = 9 > 0 \Rightarrow \text{Bette is not pivotal}$$

$$Z_A + Z_B = 15 - 2 = 13 > 0 \Rightarrow \text{Citte is not pivotal}$$

The final surpluses $S_i - T_i$ are: $15 - 8 = 7$ for Atte, -2 for Bette, and -6 for Citte.

- (d) The new setup:

€k / year	Value	Surplus	Report
Atte	$V_A = 30$	$S_A = 10$	Z_A
Bette	$V_B = 18$	$S_B = -2$	Z_B
Citte	$V_C = 6$	$S_C = -14$	Z_C

Reconsidering part 126b, we notice that the aggregate surplus would be negative. Thus, the swimming pool should not be built and total surpluses equal zero.

Likewise for part 126c, the aggregate surplus would be negative. However, in the absence of mind-reading skills, to find out that this is the efficient decision requires the VCG mechanism.

Let's check whether some of the owners are pivotal:

$$Z_A + Z_B + Z_C = 10 - 2 - 14 = -6 < 0 \Rightarrow \text{decision is "no build"}$$

$$Z_B + Z_C = -2 - 14 = -16 < 0 \Rightarrow \text{Atte is not pivotal}$$

$$Z_A + Z_C = 10 - 14 = -4 < 0 \Rightarrow \text{Bette is not pivotal}$$

$$Z_A + Z_B = 10 - 2 = 8 > 0 \Rightarrow \text{Citte is pivotal, pays tax } T_C = 8$$

The swimming pool will not be built. The surpluses are $S_A = 0$, $S_B = 0$, $S_C = T_C = -8$ thousand euros.